

## ASSEMBLY INSTRUCTION

### BS EN747-1:2012+A1:2015 SAFETY WARNING AND GENERAL NOTES: IMPORTANT – READ CAREFULLY – RETAIN FOR FUTURE REFERENCE

PLEASE READ this sheet prior to assembly to familiarise yourself with the various stages of construction. Carefully open the pack supplied and check the contents against the parts and fitting check list. Do not destroy any of the packing until you are certain that you have all the necessary parts for assembly.

**CAUTION :** There are small components used in the construction of this unit. These loose items should be kept away from young children whilst assembling your unit to avoid the danger of choking hazards.

### **WARNING :**

- Due to the size of this product we recommend that it is assembled in the room intended for use.
- This product should only be used on firm, level ground.
- **DO NOT** use power tools to construct this product.
- **DO NOT** over tighten the screw or bolts.
- **DO NOT** tighten screws until the product is fully assembled.
- **DO NOT** use solvent based cleaners or detergents as this can bleach and caused damages.
- Never use scourer, abrasives or chemical cleaners, only clean with sponge wipe and warm soapy water.
- High beds and the upper bed of the bunk beds are not suitable for children under six years due to the risk of injury from falls;
- Bunk beds and high beds can be present a serious risk of injury from strangulation if not used correctly. Never attach or hang items to any part of the bunk bed that are not designed to be used with the bed, for example, but not limited to ropes, strings, cords, hooks, belts and bags;
- Children can be trapped between the bed and wall, a roof pitch, the ceiling, adjoining pieces of furniture (e.g. cupboards) and the like. To avoid risk of serious injury the distance between the top safety barrier and the adjoining structure shall not exceed 75mm or shall be more than 230mm;
- Do not use the bunk bed/high bed if any structural part are missing, damaged or worn;
- Always follow the manufacturer's instruction
- Ensure thickness of mattress below the mark that had been made at the entrance of the upper bunk.
- Ensure the ventilation of the room is necessary in order to keep the humidity low and to prevent, mould in and around the bed.
- Ensure the support legs remain in contact with the ground at all times, and always use the ladder for entering and leaving the high bed and upper bunk.
- Ensure all screws or bolts are tightened and inspect regularly.



VISUAL IDENTIFICATION

Item Description Qty

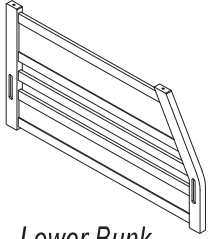

A Lower Bunk Head Board Right 1pc

Item Description Qty

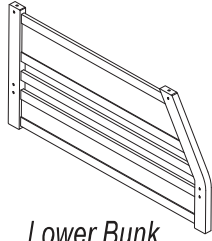

B Lower Bunk Head Board Left 1pc

Item Description Qty

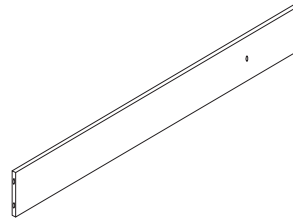

C Lower Bunk Siderail (Outer) 1pc

Item Description Qty

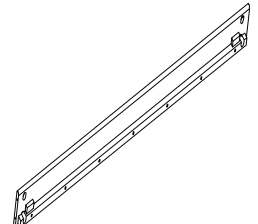

D Lower Bunk Siderail (Inner) 1pc

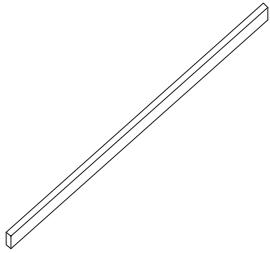

E Slat Support Rail 1pc



F Support Leg 3pcs

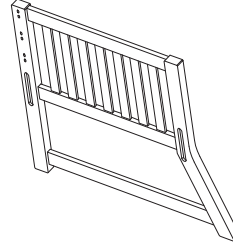

G Upper Bunk Head Board Right 1pc

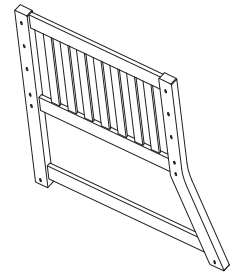

H Upper Bunk Head Board Left 1pc

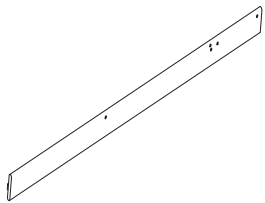

I Upper Bunk Siderail (Outer) 1pc

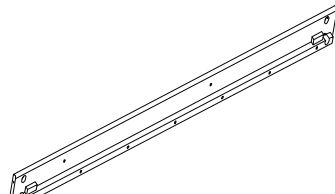

J Upper Bunk Siderail (Inner) 1pc



K Barrier Support 1 1pc

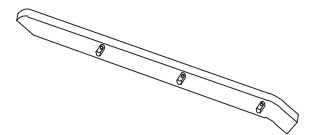

L Ladder Post Right 1pc

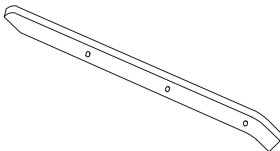

M Ladder Post Left 1pc

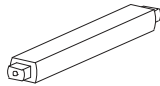

N Ladder Step 3pcs

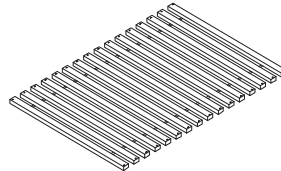

O Lower Bunk Slats Roll 1set

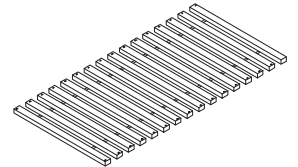

P Upper Bunk Slats Roll 1set

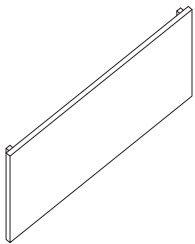

R Drawer Top 2pcs

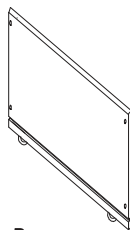

S Drawer Side Board 4pcs

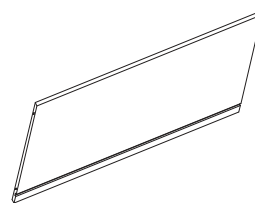

T Drawer Back Side 2pcs

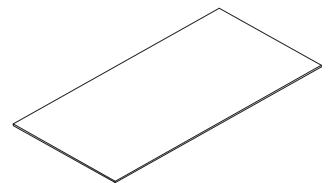

U Drawer Bottom Board 2pcs

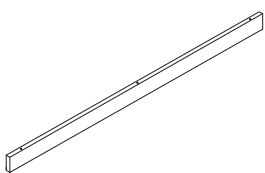

V Block Drawer Bar 1 Pcs



X Barrier Support 2 3 Pcs

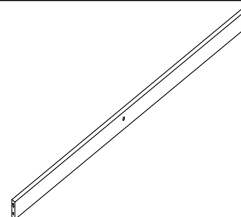



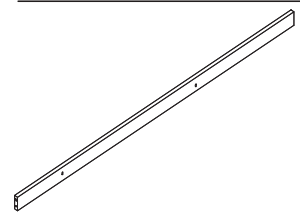







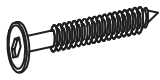

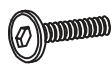
W Short Barrier 3 Pcs

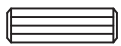
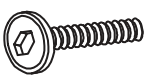

Y Long Barrier 3 Pcs

### FITTINGS CHECKLISTS

Code	Description	Qty	Code	Description	Qty	Code	Description	Qty	Code	Description	Qty
1	 Bolt M6x80	16pcs	2	 Half Moon Washer	16pcs	3	 Bolt 7.0x80	9pcs	4	 Bolt 7.0 x50	6pcs
5	 Bolt M6x30	22pcs	6	 Nuts Ø10*80*M6	4pcs	7	 Centre Rail Support	2pcs	8	 Screw 4x30	80pcs
9	 Screw 4x15	6pcs	10	 Allen Key	1pc	11	 Bolt M6x25	8pcs	12	 Wood Dowel 8x30	9pcs
13	 Bolt M6x50	2pcs	14	 Nuts Ø10*13	2pcs	15	 Bracket	1pc	Screw driver not provided)		

TOOLS REQUIRED

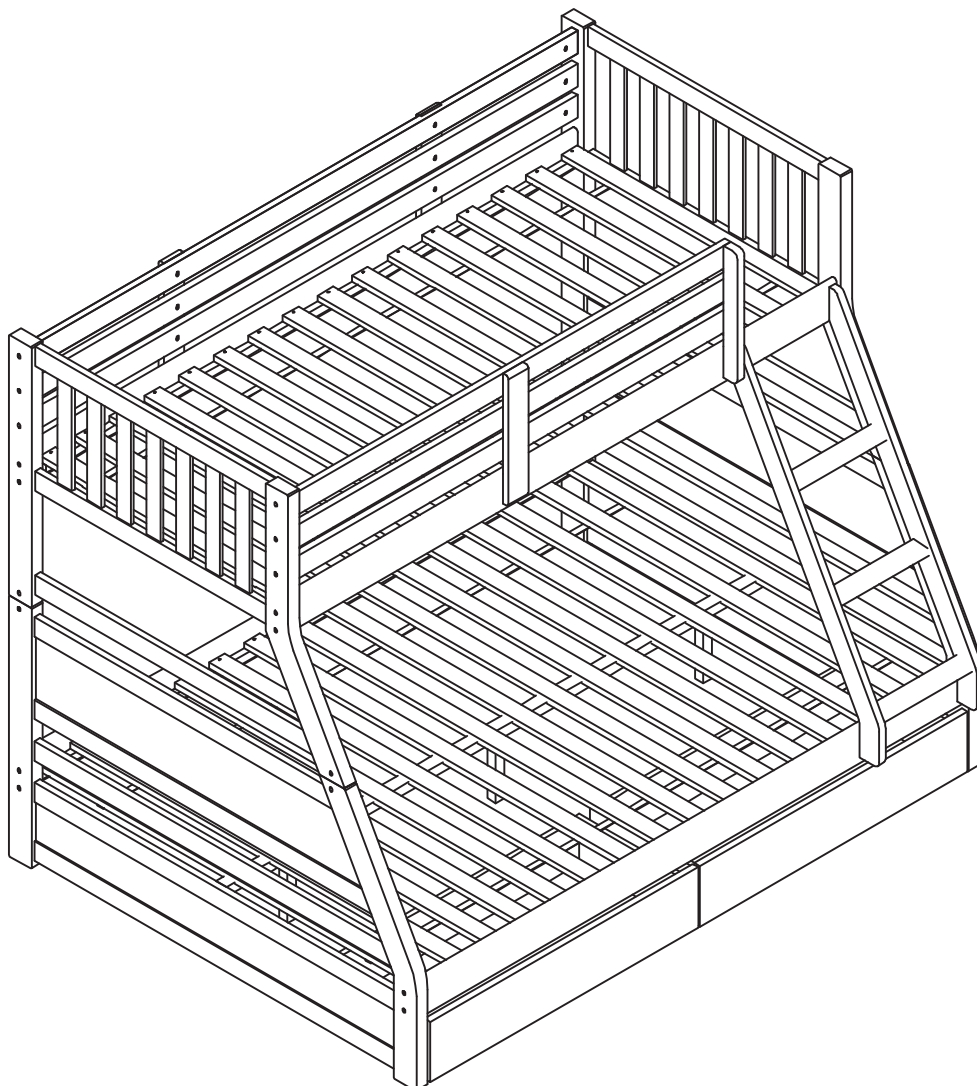

Step 1.

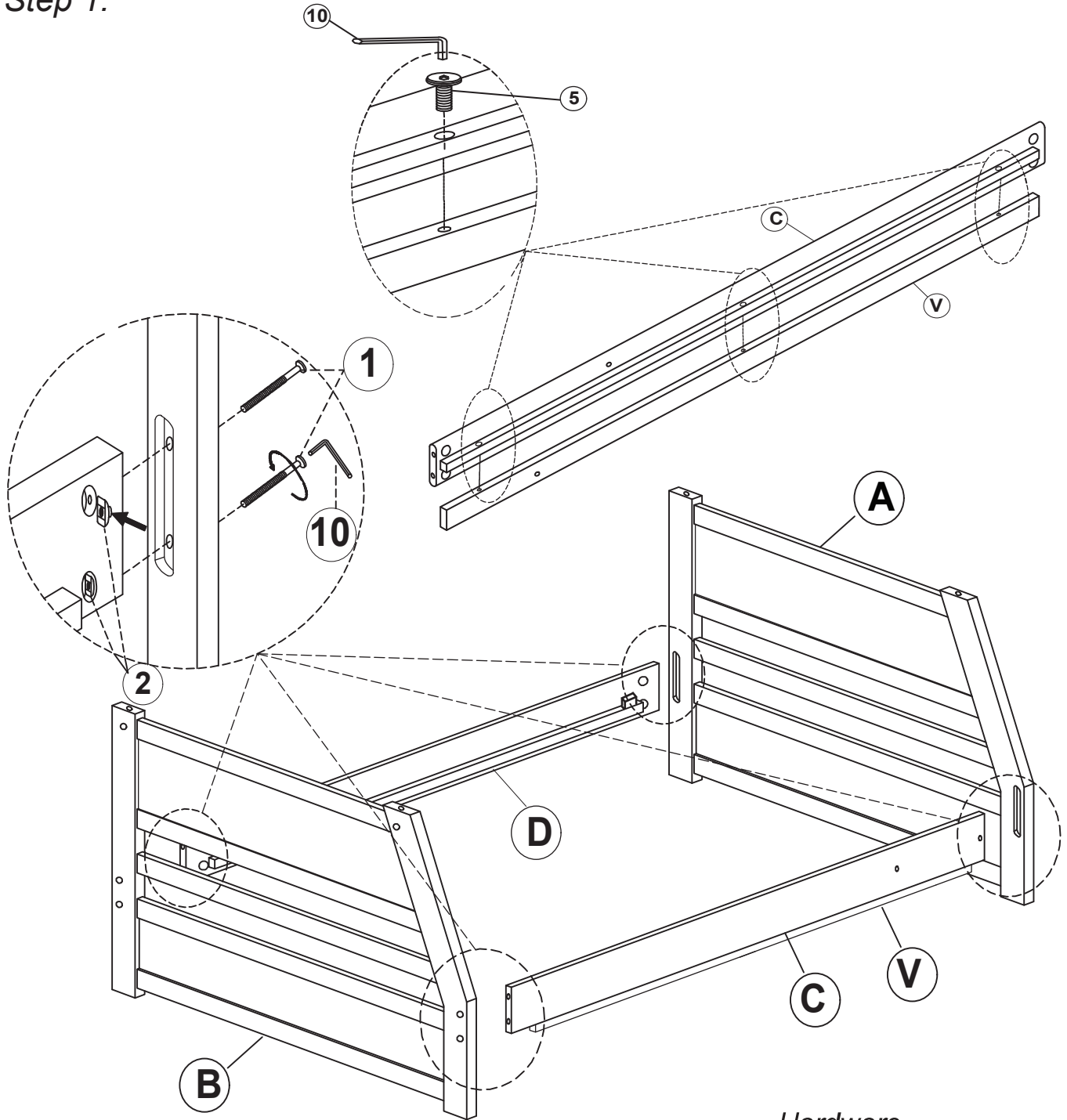

Part

Item	Description	Qty	Item	Description	Qty
A	Lower Bunk Head Board Right	1pc	B	Lower Bunk Head Board Left	1pc
C	Lower Bunk Siderail ( Outer )	1pc	D	Lower Bunk Siderail ( Inner )	1pc
V	Block Drawer Bar	1 Pcs			

Hardware

Code	Description	Qty
1	Bolt M6x80	8pcs
2	Half Moon Washer	8pcs
5	Bolt M6x30	3pcs
10	Allen Key	1pc

Step 2.

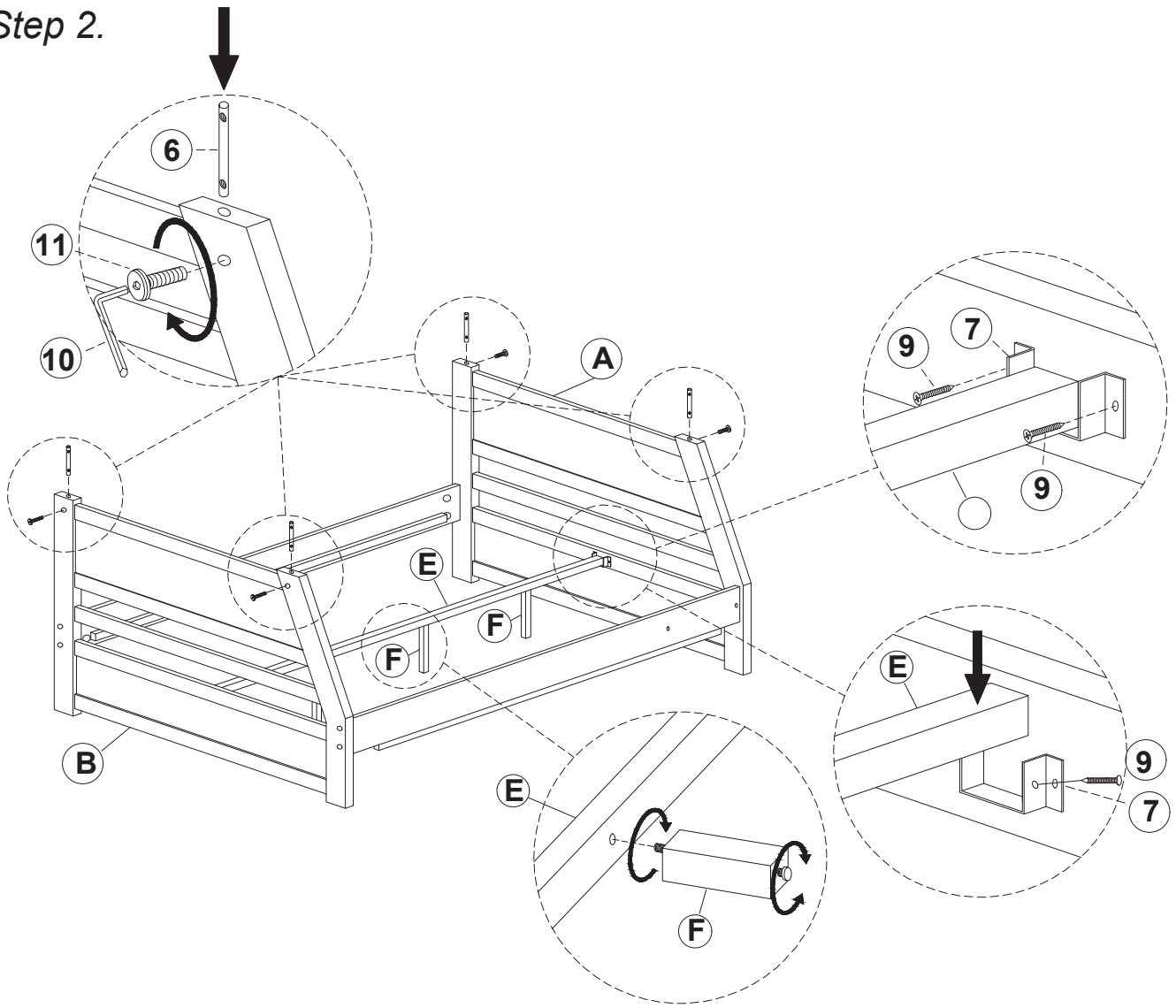

Part

<u>Item</u>	<u>Description</u>	<u>Qty</u>	<u>Item</u>	<u>Description</u>	<u>Qty</u>
E	Slat Support Rail	1pc	F	Support Leg	3pcs

Hardware

<u>Code</u>	<u>Description</u>	<u>Qty</u>
6	Nuts Ø10*80*M6	4pcs
7	Centre Rail Support	2pcs
9	Screw 4x15	6pcs
10	Allen Key	1pc
11	Bolt M6x25	4pcs

Step 3.

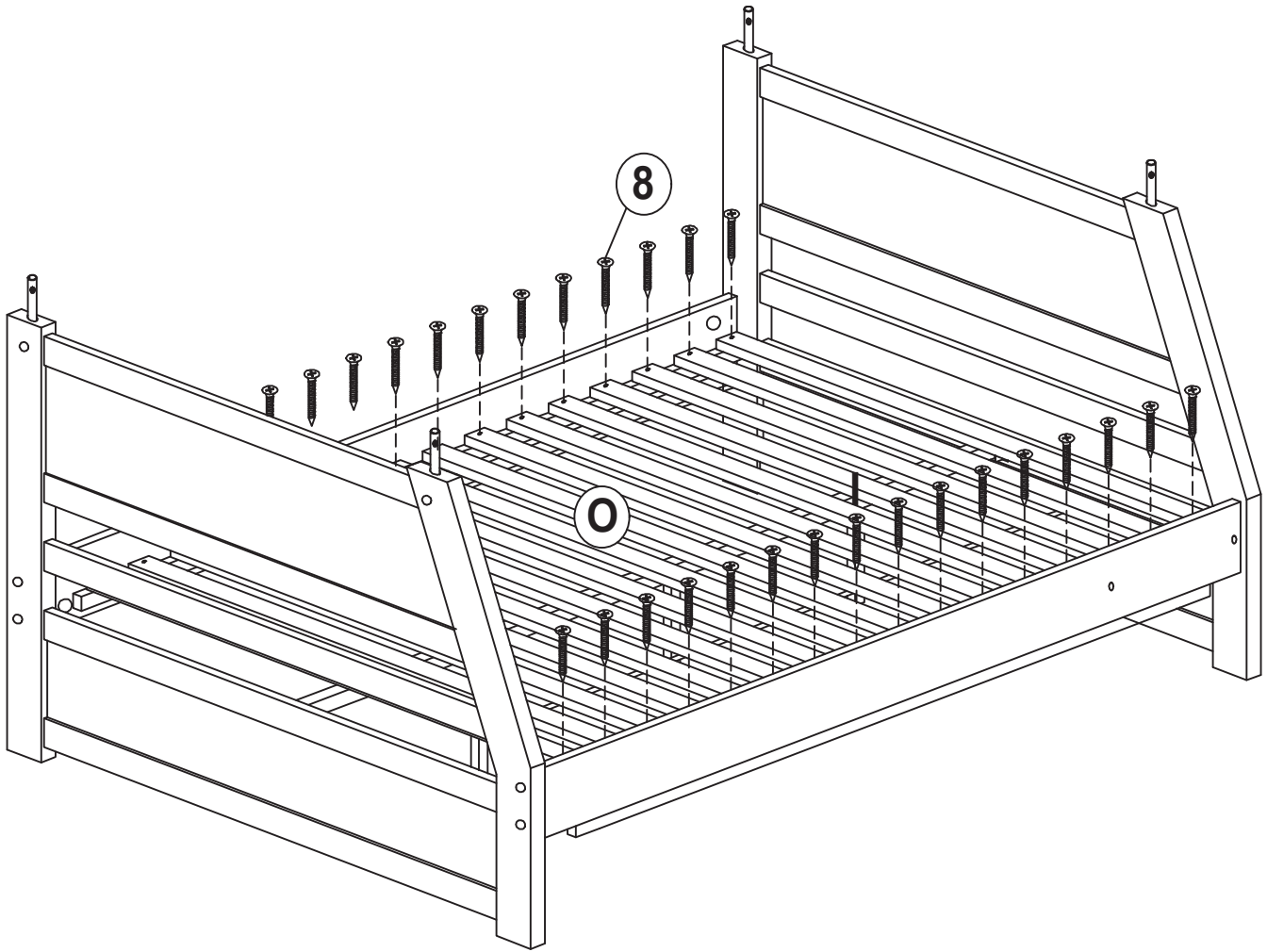

Part

<u>Item</u>	<u>Description</u>	<u>Qty</u>
-------------	--------------------	------------

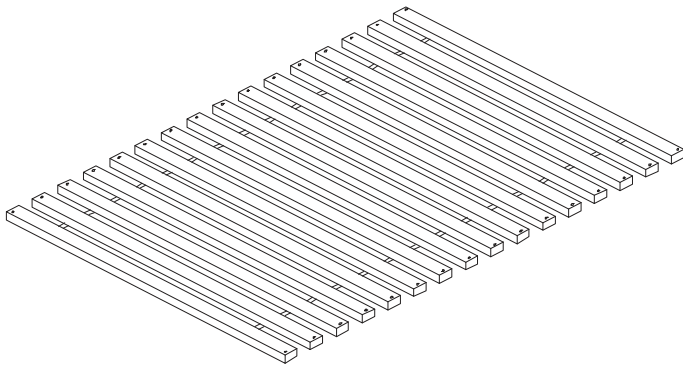

<u>0</u>	<u>Lower Bunk Slats Roll</u>	<u>1set</u>
----------	----------------------------------	-------------

Hardware

<u>Code</u>	<u>Description</u>	<u>Qty</u>
-------------	--------------------	------------

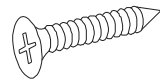

<u>8</u>	<u>Screw 4x30</u>	<u>32pcs</u>
----------	-------------------	--------------

**Step 4.**

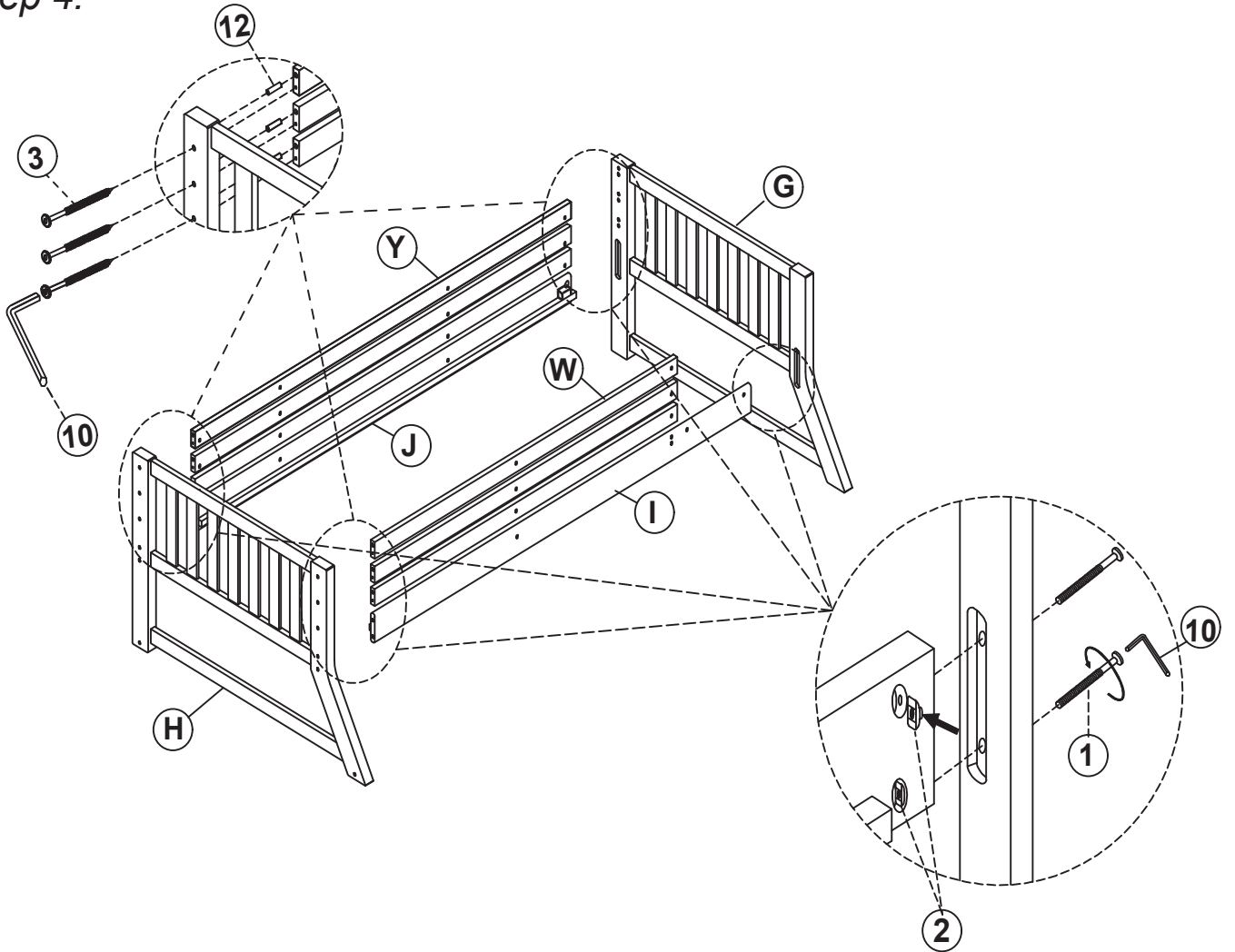

**Part**

**Hardware**

Item Description Qty

Item Description Qty

Code Description Qty

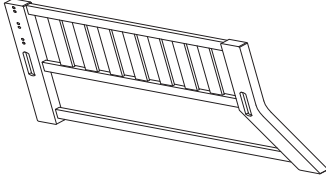

**G** Upper Bunk Head Board Right 1pc

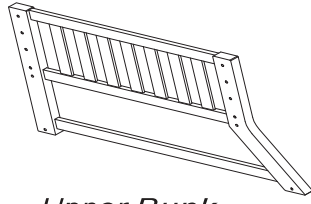

**H** Upper Bunk Head Board Left 1pc



**1** Bolt M6x80 8pcs



**2** Half Moon Washer 8pcs

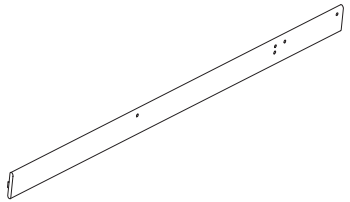

**I** Upper Bunk Siderail (Outer) 1pc

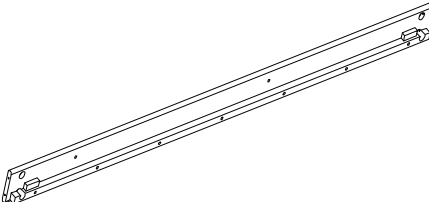

**J** Upper Bunk Siderail (Inner) 1pc



**3** Bolt 7.0x80 9pcs



**10** Allen Key 1pc

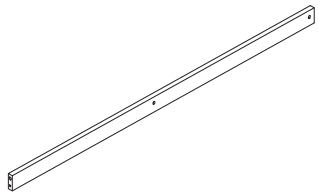

**W** Short Barrier 3 Pcs

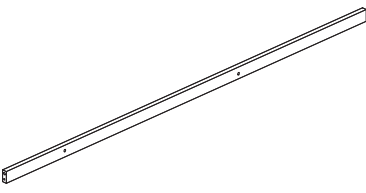

**Y** Long Barrier 3 Pcs

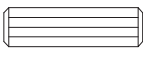

**12** Wood Dowel 8x30 9pcs



Step 5.

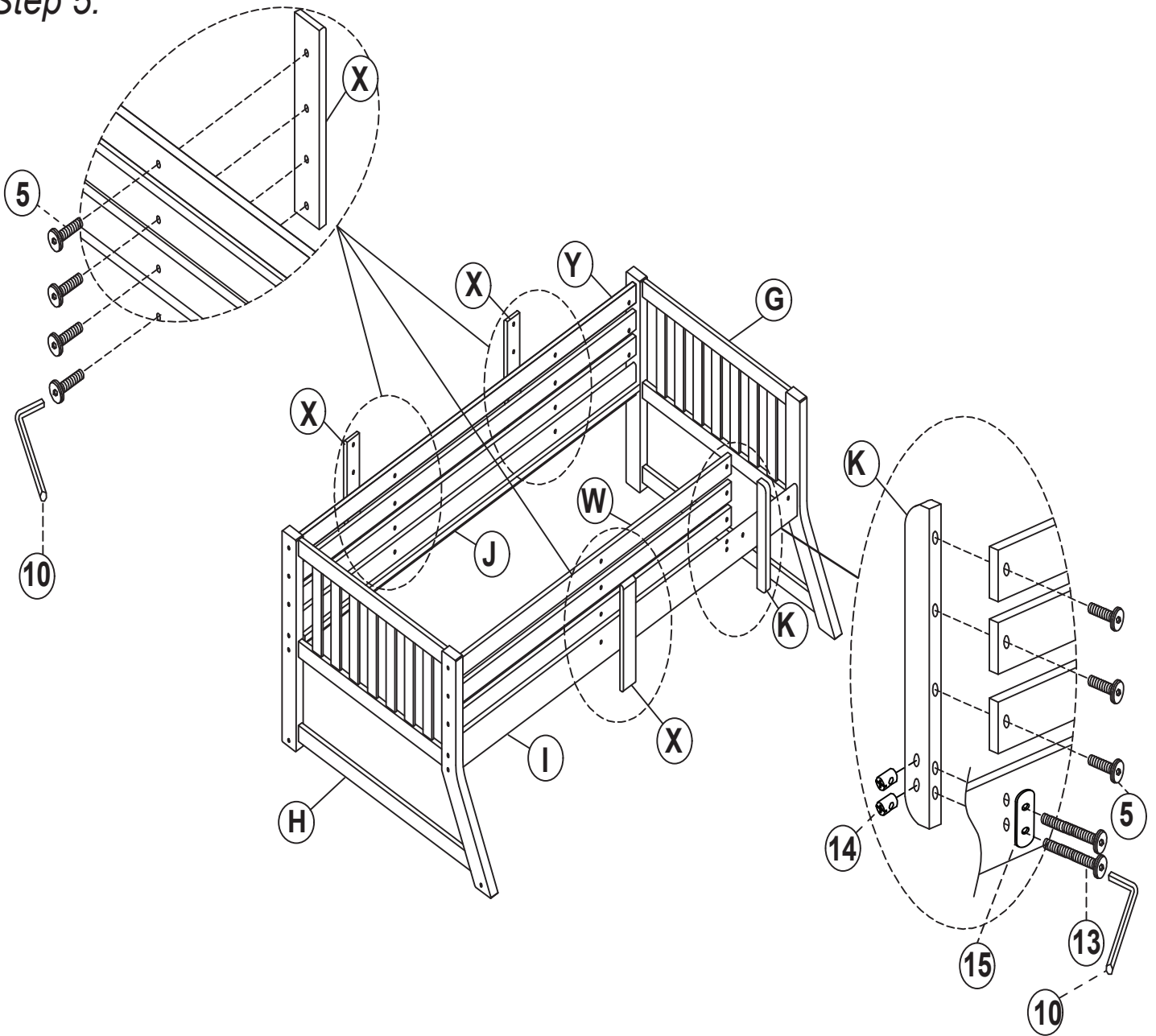

Hardware

Code Description Qty

5  Bolt M6x30 15pcs

10  Allen Key 1pc

13  Bolt M6x50 2pcs

14  Nuts Ø10\*13 2pcs

15  Bracket 1pc

Part

Item Description Qty Item Description Qty



X Barrier Support 2 3 Pcs



K Barrier Support 1 1pc



Step 6.

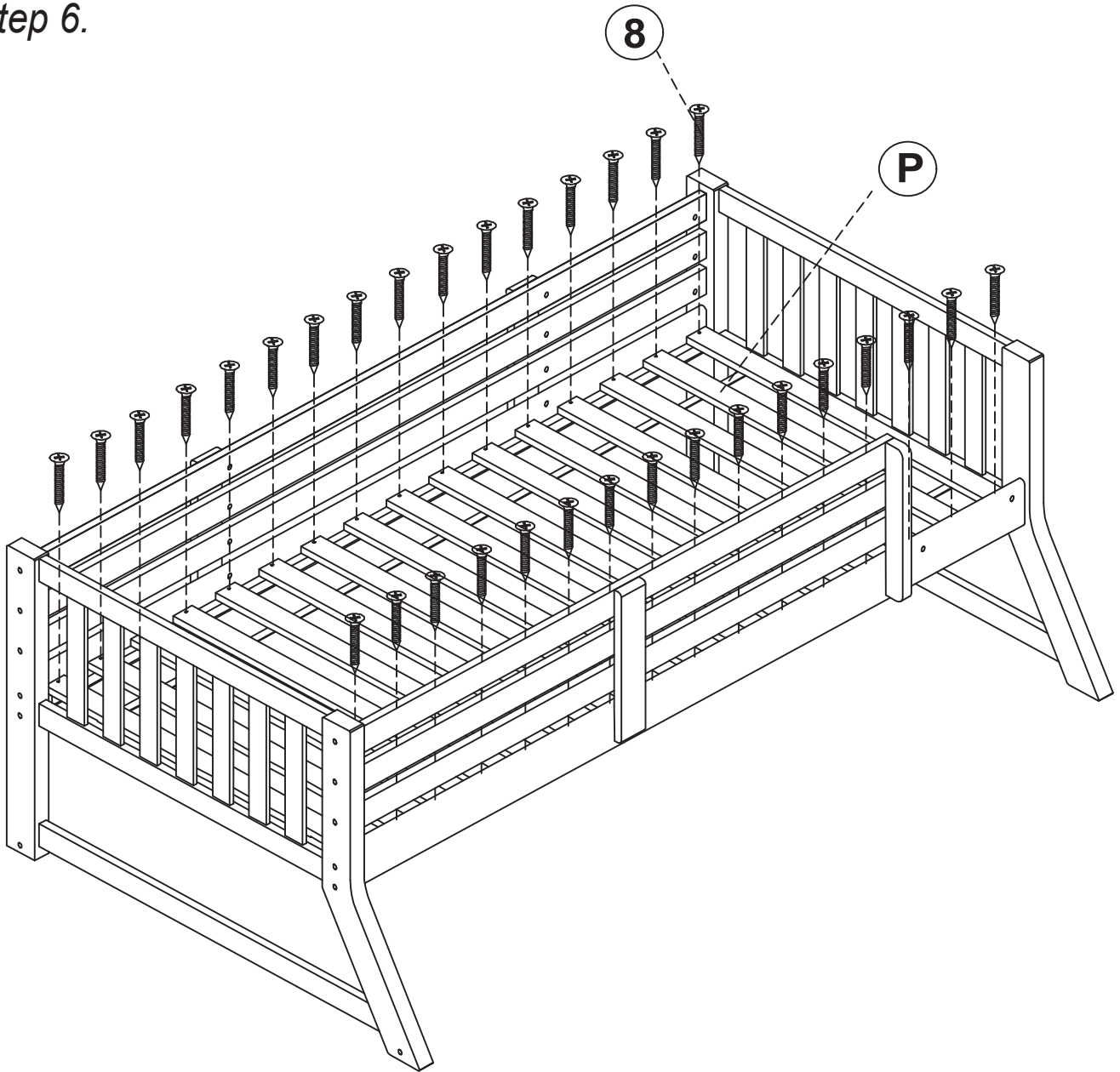

Part

<u>Item</u>	<u>Description</u>	<u>Qty</u>
-------------	--------------------	------------

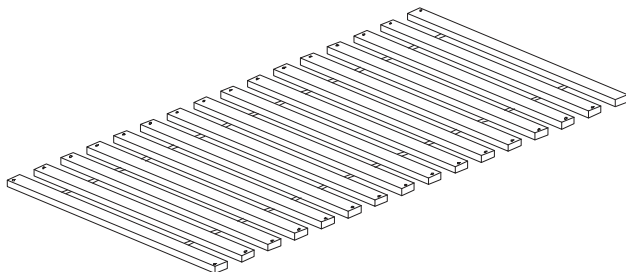

<u>P</u>	Upper Bunk Slats Roll	<u>1set</u>
----------	-----------------------	-------------

Hardware

<u>Code</u>	<u>Description</u>	<u>Qty</u>
-------------	--------------------	------------

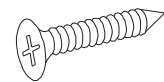

<u>8</u>	Screw 4x30	<u>32pcs</u>
----------	------------	--------------

## Step 7.

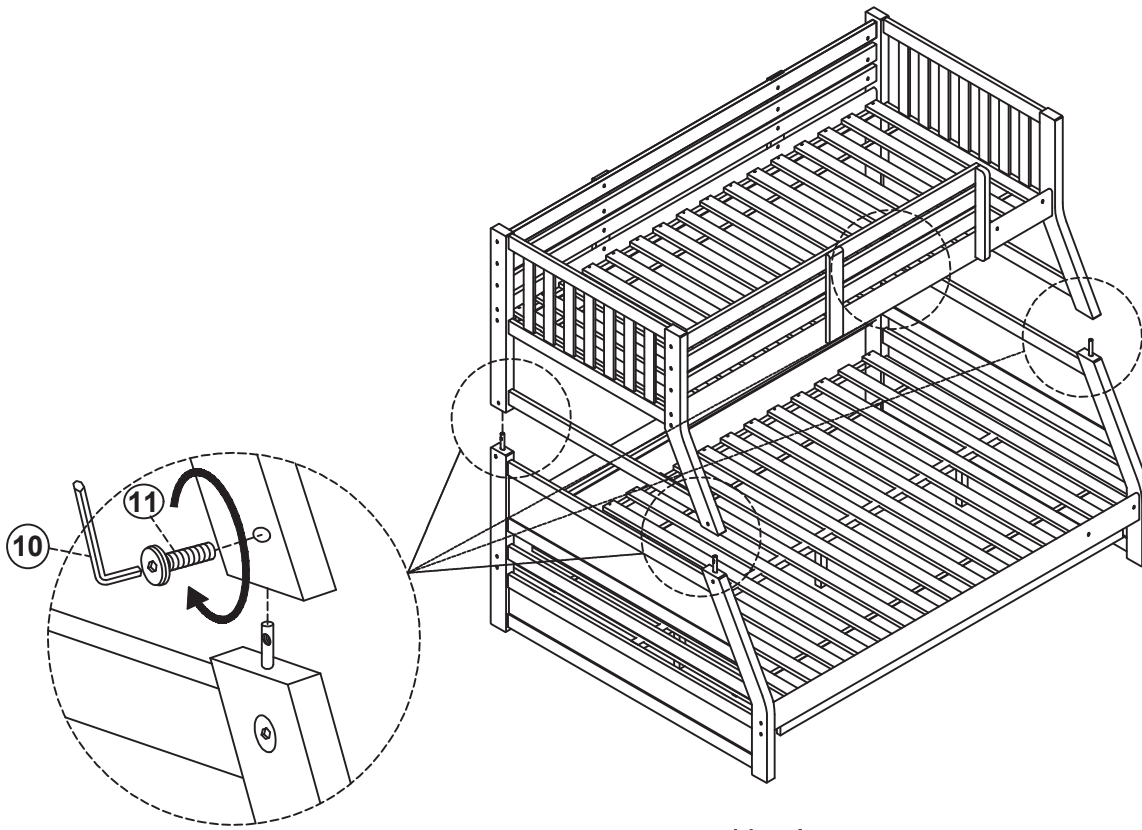

### Hardware

Code	Description	Qty	Code	Description	Qty
------	-------------	-----	------	-------------	-----

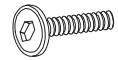

10	Allen Key	1pc	11	Bolt M6x25	4pcs
----	-----------	-----	----	------------	------



4	Bolt 7.0 x50	6pcs
---	--------------	------

## Step 8.

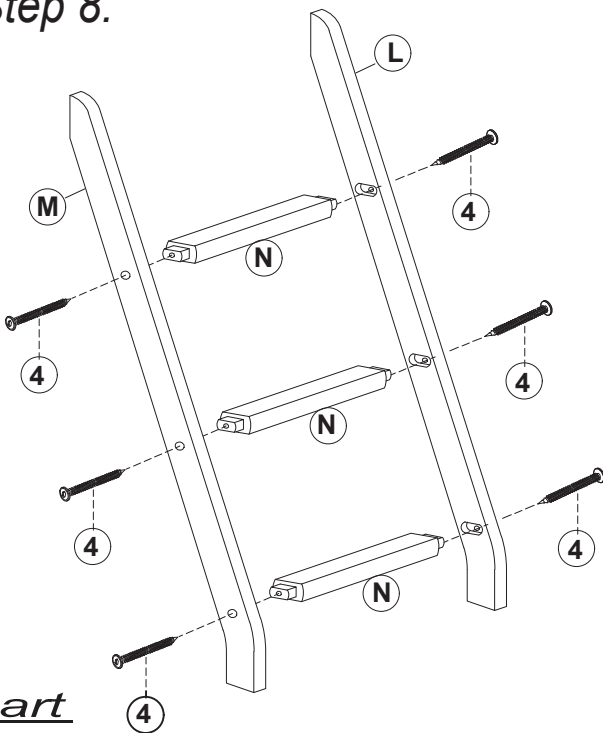

### Part

Item	Description	Qty	Item	Description	Qty	Item	Description	Qty
------	-------------	-----	------	-------------	-----	------	-------------	-----

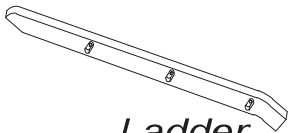

Ladder Post Right

L

1pc

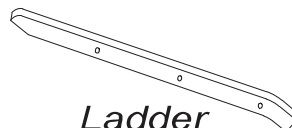

Ladder Post Left

M

1pc

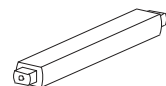

Ladder Step

N

3pcs

## Step 8.

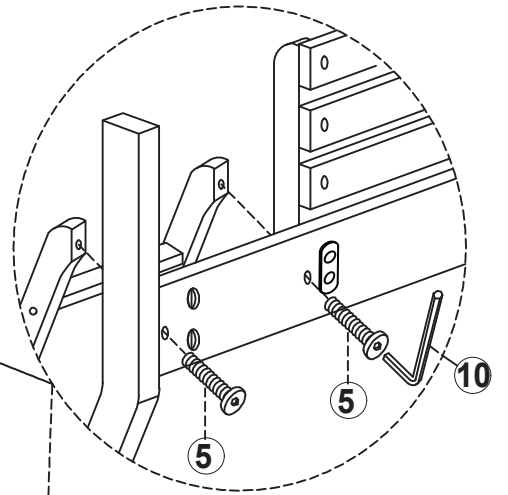
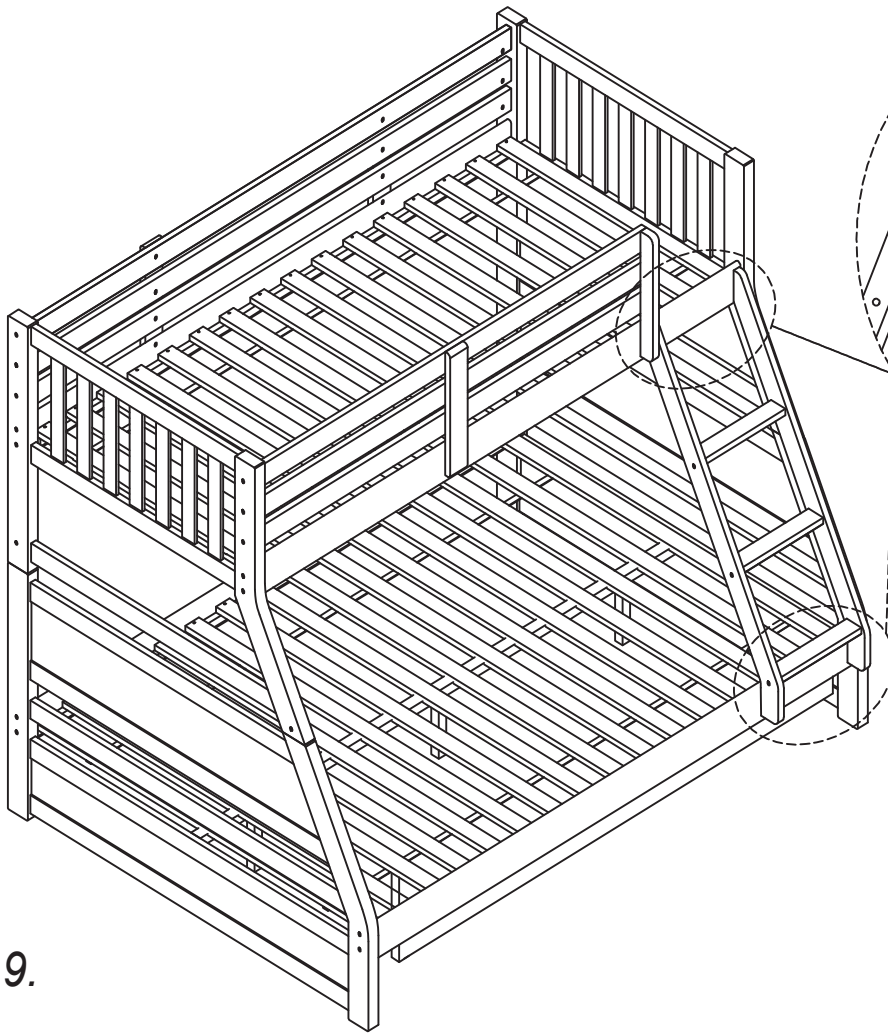

### Hardware

Code	Description	Qty
------	-------------	-----

5	Bolt M6x30	4pcs
---	------------	------

8	Screw 4x30	16 pcs
---	------------	--------

10	Allen Key	1pc
----	-----------	-----

## Step 9.

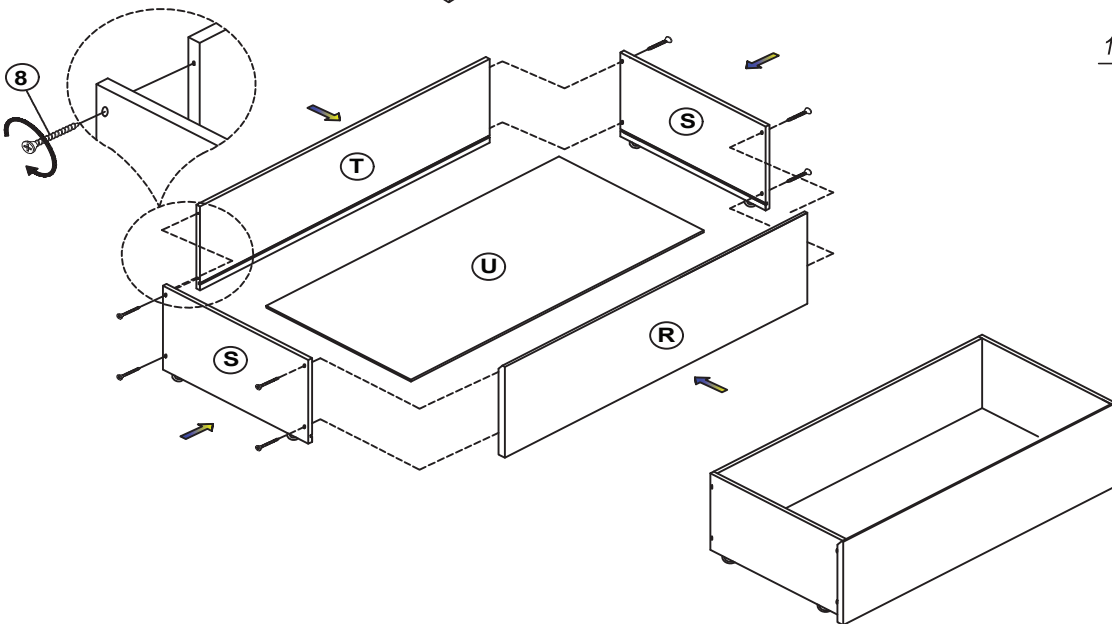

### Part

Item	Description	Qty	Item	Description	Qty	Item	Description	Qty	Item	Description	Qty
R	Drawer Top	2pcs	S	Drawer Side Board	4pcs	T	Drawer Back Side	2pcs	U	Drawer Bottom Board	2pcs

*FINISH*

