

Thank you for purchasing this light fitting. Please read the instructions carefully before use to ensure safe and satisfactory operation of this product. Please keep these instructions for future reference.

Warnings!

 This fitting is a Class II, double insulated product. It does not require an Earth, and Live or Neutral must not be connected to Earth.

This product is only suitable for connection to a 240V~50Hz supply in accordance with current IEE wiring regulations. It should be installed in accordance with local building regulations and is for indoor use only. It is not suitable for a bathroom location.

Before installing your light fitting always switch off the mains supply and remove the appropriate fuse or switch off the appropriate circuit breaker before commencing installation.

Never fit bulbs of a higher wattage than those specified on the label, as these may cause overheating and damage the fitting.

This product is suitable for use with a dimmer switch, when used with dimmable bulbs.

If you are in any doubt about your competence please consult a qualified electrician.

If any modification is made it will invalidate the warranty and may render the product unsafe.

Keep children and animals away from the assembly area.

Keep all plastic wrapping materials away from children to avoid danger of suffocation.

Ensure that all packaging is disposed of carefully and responsibly.

Fixing Instructions

Make sure you have the following items which are required to install this light fitting:

Small electrical screwdriver, cross head screwdriver & insulation tape.

Step 1

Decide on the position of the light fitting or remove existing light fitting. Note the position of the electrical connections, and ensure there is a solid mounting surface, preferably a wooden joist or joist bridge, to support the weight of the light fitting.

Step 2

Remove the mounting bracket (1) from the ceiling cup by loosening the two side screws (2).

Step 3

Using the mounting bracket as a template, mark the position of the mounting holes. Taking care to avoid damaging concealed wires and pipes, drill holes and fit supplied wall plugs (3) (suitable for masonry only - for other surfaces use appropriate fixings). Fix the mounting bracket to the ceiling using the supplied screws (4).

Step 4

The hanging height of this product can be adjusted. Feed the cable through the cord grip (5) until the desired height is achieved. It maybe necessary to cut, shorten and reconnect the cable. If you are unsure how to do this, contact a qualified electrician.

Please note: If there is a screw clamp inside the ceiling cup, do not loosen the screws as this is securing the cable into the terminal block.

Step 5

Having identified the household wiring from your existing light fitting, connect to the connection block (6) inside the product in the following way:

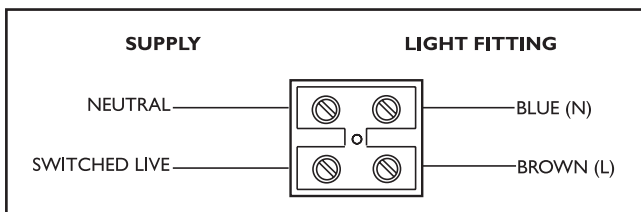

Check that...

You have correctly identified the house wires.

The connections are tight.

No loose strands have been left out of the connection block.

Make sure the lid of the connection box is securely fixed.

Step 6

Refit the product to the mounting bracket. This product has "L" shaped fixing holes to allow easy fixing to the mounting bracket. Locate the "L" slots (7) around the side screws (2) on mounting bracket (1). Rotate the ceiling cover to attach the product to the bracket. Tighten the screws to secure. Take care not to trap any wiring.

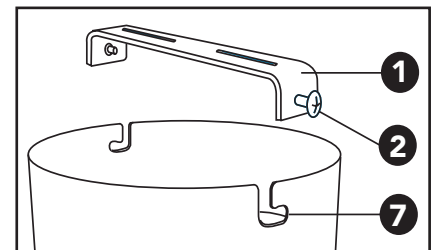

Step 7

Fit the bulb (8). Max. 10W LED E27 GLS. **NOTE: Never fit bulbs of a higher wattage than those specified on the label (as this may cause overheating and damage the fitting).**

Step 8

Replace fuse or circuit breaker and switch on to test. Your light is now ready for use.

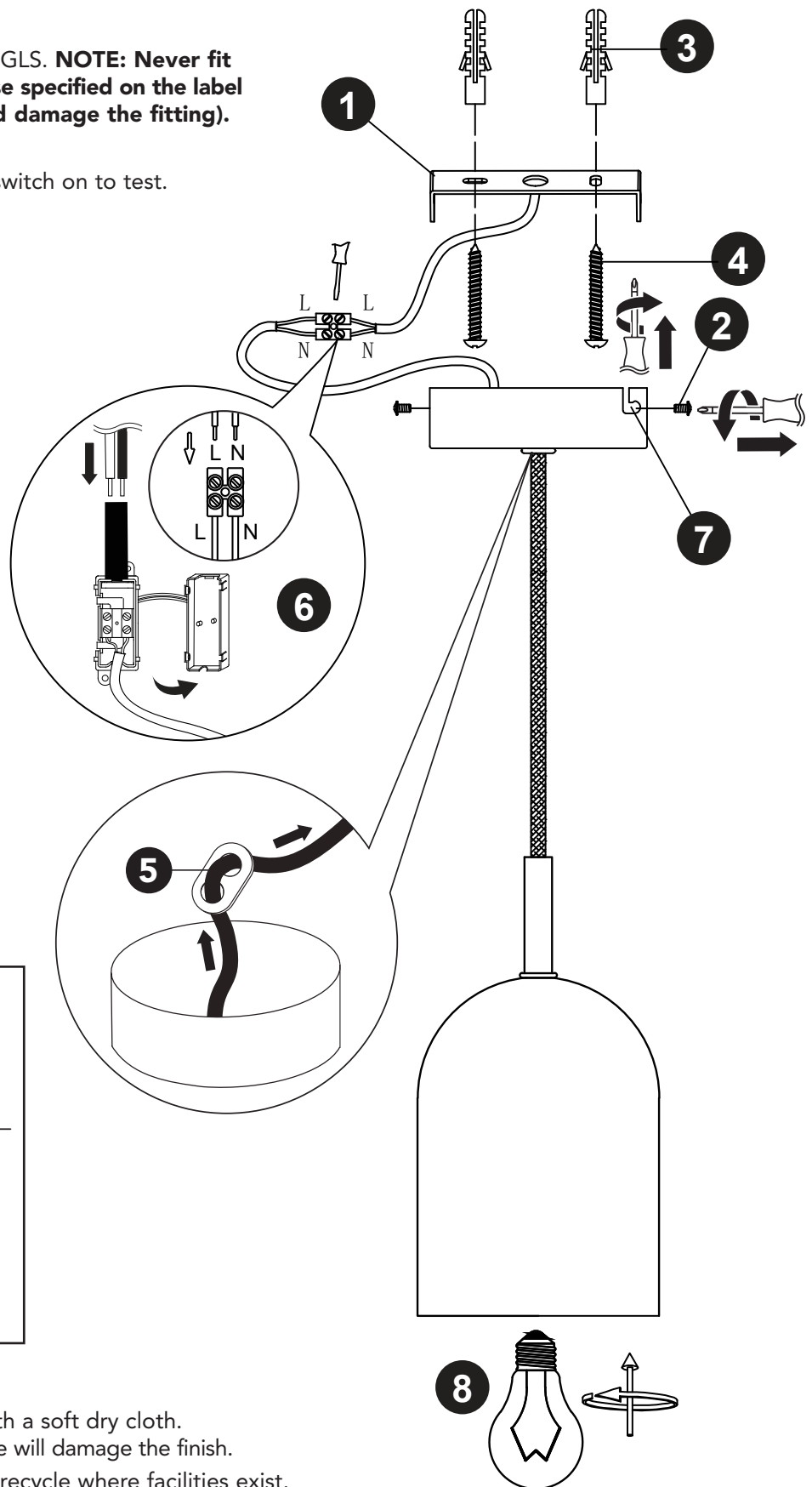

Note: During transit, the cable can become kinked. It may be necessary to straighten the cable to allow the shade to hang level.

Manipulate the kinked cable between thumb and fingers to straighten.

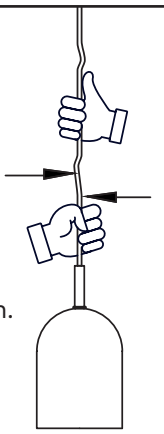



Care and cleaning

Finish - We recommend cleaning with a soft dry cloth.

Do not use abrasive materials as these will damage the finish.

Our packaging is recyclable, please recycle where facilities exist.

-  Waste electrical products should not be disposed of with household waste.
-  Please recycle where facilities exist. Check with your Local Authority or retailer for recycling advice.

— We're happy to recycle your old light for free. Simply bring it to store within 28 days of purchase of your new light, with your receipt, and we'll make sure your old light stays out of landfill.

dunelm.com

Manufactured in China for
Dunelm (Soft Furnishings) Ltd. LE7 1AD
& Dunelm (Soft Furnishings)
Londonderry Ltd. BT48 8QN

