

**INSTRUCTION MANUAL**  
***MANUEL D'INSTRUCTION***  
**MANUAL DE INSTRUCCIONES**

**7640**

**SINGER *is sewing made easy.***<sup>TM</sup>

# INTRODUCTION

## Welcome

Welcome to the SINGER® family and CONGRATULATIONS on purchasing a brand new SINGER® sewing machine!

The SINGER® brand has stood for quality in sewing for over 160 years. We design our machines for sewists of all skill levels so that the joy of sewing, creating, do-it-yourself, crafting and more can be enjoyed by all. It is important to us that you have the easiest and most successful sewing experience. We have provided an instruction manual with easy-to-understand graphics and step-by-step instructions. Additional assistance, by region, may be found on the web at [www.singer.com](http://www.singer.com).

We're ready to help and hope that you enjoy your SINGER® sewing machine.

Happy Sewing!

This household sewing machine is designed to comply with IEC/EN 60335-2-28 and UL1594.

## IMPORTANT SAFETY INSTRUCTIONS

When using an electrical appliance, basic safety precautions should always be followed, including the following:

Read all instructions before using this household sewing machine. Keep the instructions in a suitable place close to the machine. Make sure to hand them over if the machine is given to a third party.

### **DANGER - To reduce the risk of electric shock :**

- A sewing machine should never be left unattended when plugged in. Always unplug this sewing machine from the electric outlet immediately after using and before cleaning, removing covers, lubricating or when making any other user servicing adjustments mentioned in the instruction manual.

### **WARNING - To reduce the risk of burns, fire, electric shock, or injury to person :**

- Do not allow to be used as a toy. Close attention is necessary when this sewing machine is used by or near children.
- Use this sewing machine only for its intended use as described in this manual. Use only attachments recommended by the manufacturer as contained in this manual.
- Never operate this sewing machine if it has a damaged cord or plug, if it is not working properly, if it has been dropped or damaged, or dropped into water. Return the sewing machine to the nearest authorized dealer or service center for examination, repair, electrical or mechanical adjustment.
- Never operate the sewing machine with any air openings blocked. Keep ventilation openings of the sewing machine and foot control free from the accumulation of lint, dust, and loose cloth.
- Keep fingers away from all moving parts. Special care is required around the sewing machine needle.
- Always use the proper needle plate. The wrong plate can cause the needle to break.
- Do not use bent needles.
- Do not pull or push fabric while stitching. It may deflect the needle causing it to break.
- Wear safety glasses.
- Switch the sewing machine off ("O") when making any adjustment in the needle area, such as threading needle, changing needle, threading bobbin, or changing presser foot, etc.
- Never drop or insert any object into any opening.
- Do not use outdoors.
- Do not operate where aerosol (spray) products are being used or where oxygen is being administered.

# INTRODUCTION

## Important Safety Instructions

- To disconnect, turn all controls to the off (“O”) position, then remove plug from outlet.
- Do not unplug by pulling on cord. To unplug, grasp the plug, not the cord.
- The foot control is used to operate the machine. Avoid placing other objects on the foot control.
- Do not use the machine if it is wet.
- If the LED lamp is damaged or broken, it must be replaced by the manufacturer or its service agent or a similarly qualified person, in order to avoid a hazard.
- If the supply cord connected with the foot control is damaged, it must be replaced by the manufacturer or its service agent or a similarly qualified person, in order to avoid a hazard.
- This sewing machine is provided with double insulation. Use only identical replacement parts. See instructions for Servicing of Double-Insulated Appliances.

## SAVE THESE INSTRUCTIONS

#### **For Europe only :**

This appliance can be used by children aged from 8 years and above and persons with reduced physical, sensory or mental capabilities or lack of experience and knowledge if they have been given supervision or instruction concerning use of the appliance in a safe way and understand the hazards involved. Children shall not play with the appliance. Cleaning and user maintenance shall not be made by children without supervision.

The noise level under normal operating conditions is less than 75dB(A).

The machine must only be used with foot control of type C-8000 manufactured by ZENG HSING TAIWAN, LTD.

#### **For outside Europe :**

This sewing machine is not intended for use by persons (including children) with reduced physical, sensory or mental capabilities, or lack of experience and knowledge, unless they have been given supervision or instruction concerning use of the sewing machine by a person responsible for their safety. Children should be supervised to ensure that they do not play with the sewing machine.

The noise level under normal operating conditions is less than 75dB(A).

The machine must only be used with foot control of type C-8000 manufactured by ZENG HSING TAIWAN, LTD.

## **SERVICING OF DOUBLE INSULATED PRODUCTS**

In a double-insulated product, two systems of insulation are provided instead of grounding. No ground means is provided on a double-insulated product, nor should a means for grounding be added to the product. Servicing of a double-insulated product requires extreme care and knowledge of the system and should be done only by qualified service personnel. Replacement parts for a double-insulated product must be identical to those parts in the product. A double-insulated product is marked with the words "DOUBLE INSULATION" or "DOUBLE INSULATED".

# INTRODUCTION

## Table of Contents

<b>INTRODUCTION</b> .....	<b>2-6</b>
Welcome .....	2
Important Safety Instructions .....	3-5
Table of Contents .....	6
<b>1. ABOUT YOUR MACHINE</b> .....	<b>7-11</b>
Main Parts of the Machine Front .....	7
Main Parts of the Machine Back .....	8
Needle and Presser Foot Area .....	9
Removable Storage Compartment and Accessories .....	10-11
<b>2. GETTING READY TO SEW</b> .....	<b>12-17</b>
Powering Your Machine .....	12
Winding the Bobbin .....	13
Inserting the Bobbin .....	14
Threading the Upper Thread .....	15
Automatic Needle Threader .....	16
Drawing Up the Bobbin Thread .....	17
<b>3. START SEWING</b> .....	<b>18-31</b>
Before You Start Sewing .....	18
Stitch Formation .....	19
Operation Buttons and Function Buttons .....	20
LCD Screen .....	20
Combining Characters into Memory .....	21
Stitch Selection .....	22
Sewing a Straight Stitch .....	23
Sewing a Decorative Stitch .....	24
Sewing a Stretch Stitch .....	25
Sewing a 1-Step Buttonhole .....	26
Sewing a Button .....	27
Inserting and Changing Needles .....	28
Changing the Presser Foot and Presser Foot Lift .....	29
Two-Step Extra Presser Foot Lift .....	29
Presser Feet .....	30-31
<b>4. TROUBLESHOOTING AND MAINTENANCE</b> .....	<b>32-37</b>
Troubleshooting .....	32-36
Maintenance .....	37
<b>5. APPENDIX - GLOSSARY</b> .....	<b>38</b>
Glossary of Key Sewing Terms .....	38

Explanation key to notations in this manual:

 = Helpful information

 = Could cause harm

 = Impacts sewing results

To ensure that you are always provided with the most modern sewing capabilities, the manufacturer reserves the right to change appearance, design or accessories of this sewing machine when considered necessary.

SINGER and SINGER IS SEWING MADE EASY is a registered trademark of The SINGER Company Limited or its affiliates.

© 2017 The SINGER Company Limited or its affiliates. All rights reserved.

# ABOUT YOUR MACHINE

## Main Parts of the Machine Front

1

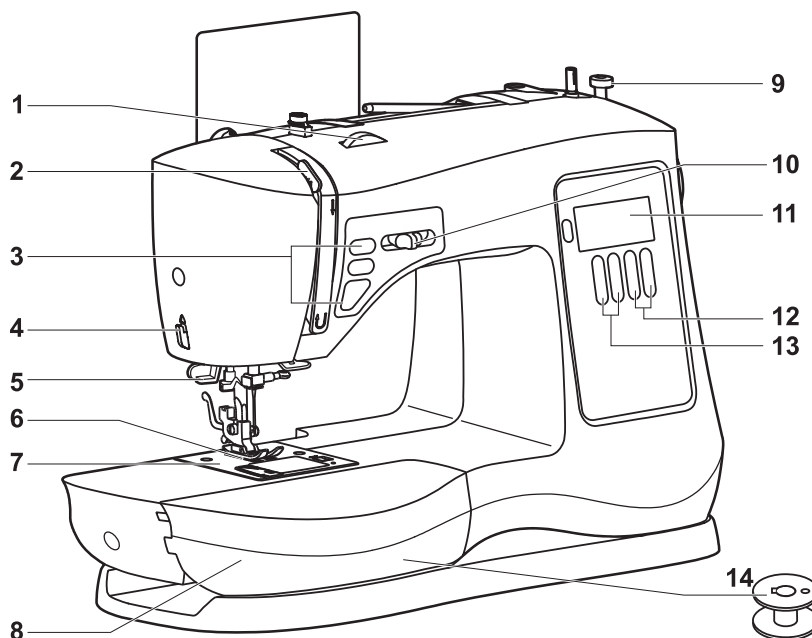

1. **THREAD TENSION DIAL** allows you to select just the right tension for your stitch, thread and fabric. (See Page 19)
2. **THREAD TAKE-UP LEVER** controls the flow of the upper thread while sewing. (See Page 15)
3. **OPERATION BUTTONS** control the needle up/down and Start/Stop functions, as well as the reverse function. (See Page 20)
4. **THREAD CUTTER** is conveniently located for trimming thread ends at the end of sewing.
5. **NEEDLE THREADER LEVER** is used to engage the automatic needle threader. (See Page 16)
6. **PRESSER FOOT** holds fabric against feed teeth, drawing fabric under the foot for you as you sew. (See Page 29)
7. **NEEDLE PLATE** has guidelines to help you keep seams straight. (See Page 9)
8. **REMOVABLE STORAGE COMPARTMENT** provides flat surface for sewing, storage for accessories, and provides access to the free arm. (See Page 10)
9. **BOBBIN WINDING STOPPER** determines when bobbin is full and disengages automatically. (See Page 13)
10. **SPEED CONTROL ADJUSTMENT LEVER** controls the speed at which the machine sews when using the Foot Control or the manual Start/Stop Button. (See Page 20)
11. **LCD SCREEN** visually displays the stitch number, the stitch length or the stitch width depending on what Mode you have selected (See Page 20)
12. **FUNCTION BUTTONS** control the stitch width and the stitch length, as well as the pattern memory for alpha and numerical stitches. (See Page 21 and 22)
13. **PATTERN ADJUSTMENT BUTTONS** control the selection of the stitch patterns. The left button controls the left digit and the right button controls the right digit. (See Page 20 and 22)
14. **BOBBIN** holds the thread that forms the stitching that appears on the bottom side of the fabric. (See Page 14)

# 1

## ABOUT YOUR MACHINE

### Main Parts of the Machine Back

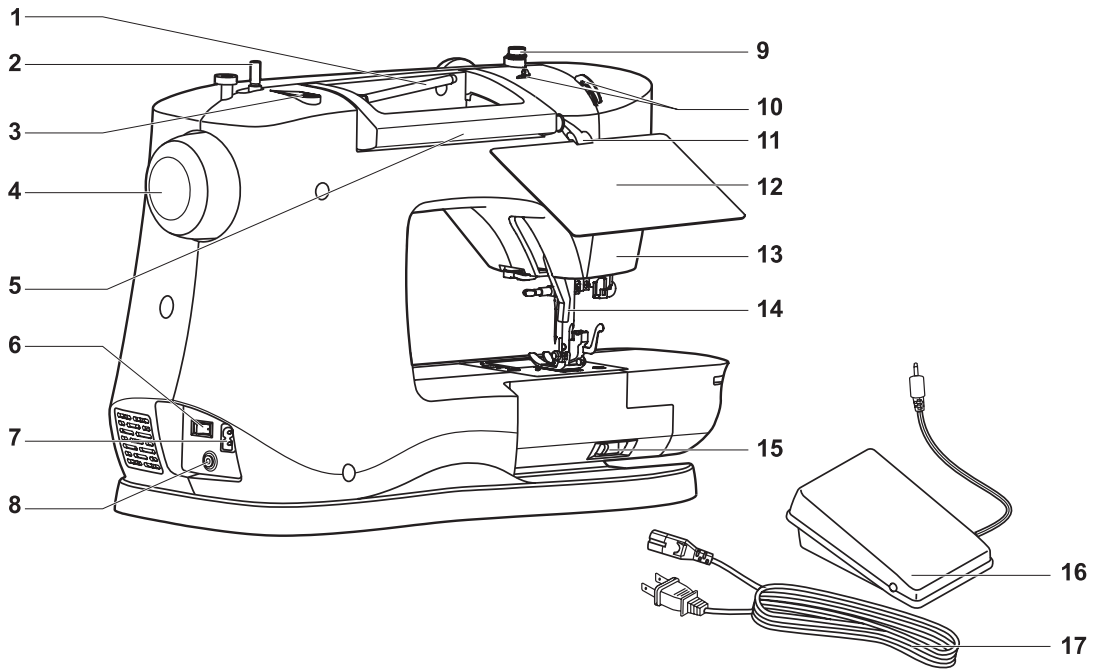

1. **HORIZONTAL SPOOL PIN** holds the thread spool and spool cap for the upper thread.
2. **BOBBIN WINDING SPINDLE** holds bobbin as it winds. (See Page 13)
3. **HOLE FOR SECOND SPOOL PIN** is used to hold an additional spool pin, for thread spools to be used in upright position or for using two spools at once for twin needle sewing.
4. **HANDWHEEL (ALWAYS TURN IT TOWARD YOU)**, controls movement of the needle and the thread take-up lever.
5. **HANDLE** is used for lifting and transporting the machine.
6. **POWER AND LIGHT SWITCH** turns on machine and sewing light simultaneously. (See Page 12)
7. **MAIN PLUG SOCKET** is used to connect the power cord. (See Page 12)
8. **FOOT CONTROL CONNECTOR** is where the foot control connects to the machine. (See Page 12)
9. **BOBBIN WINDING TENSION DISK** holds the thread snugly to help ensure smooth and even bobbin winding. (See Page 13)
10. **PRE-TENSION THREAD GUIDES** help maintain the flow of the thread during sewing. (See Page 15)
11. **STITCH CHART HOLDER** is inserted into the left side of the handle to hold the Pattern Stitch Chart.
12. **STITCH PATTERN CHART** shows all available stitches for easy selection. Flip it toward you in order to view the stitches. This chart is located in the bag where the instruction manual is stored.
13. **FACE PLATE** houses and protects the interior mechanisms of the machine.
14. **PRESSER FOOT LIFTER** raises and lowers presser foot. It should be placed up for machine threading and down for sewing. (See Page 29)
15. **DROP FEED LEVER** controls whether the feed teeth are up for sewing or down for attaching a button. (See Page 27)
16. **FOOT CONTROL** controls sewing speed by the amount of pressure applied by user. (See Page 12)
17. **POWER CORD** connects the machine to the power source. (See Page 12)



# ABOUT YOUR MACHINE

## Needle and Presser Foot Area

1

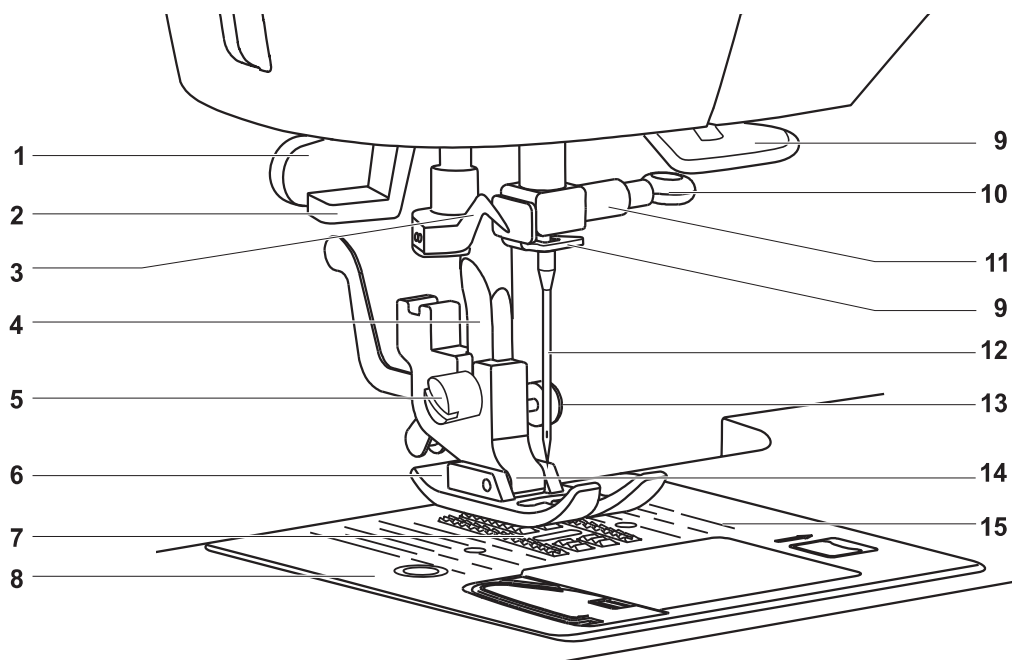

1. **ONE STEP BUTTONHOLE LEVER** automatically determines the length of the buttonhole when lowered. (See Page 26)
2. **NEEDLE THREADER LEVER** is used to engage the automatic needle threader mechanism.
3. **NEEDLE THREADER GUIDE** holds thread securely before placing it in hook pin.
4. **PRESSER BAR** accommodates the presser foot holder.
5. **PRESSER FOOT SCREW** secures the presser foot holder (shank) onto the presser bar.
6. **PRESSER FOOT** holds fabric against the feed teeth while sewing. Various optional presser feet are available, depending on fabric sewn and sewing techniques. (See Page 11)
7. **FEED TEETH (OR FEED DOGS)**, which look like rows of teeth under the presser foot, control the movement of the fabric under the presser foot.
8. **NEEDLE PLATE** covers the bobbin area and provides flat area around presser foot for sewing.
9. **THREAD GUIDE** controls movement of upper thread.
10. **NEEDLE CLAMP SCREW** secures the needle when placed in needle clamp.
11. **NEEDLE CLAMP** holds the machine's needle in position.
12. **NEEDLE** holds thread during stitch formation.
13. **LOCK IN PLACE BUTTON** helps with even feeding over extra thick seams.
14. **PRESSER FOOT HOLDER (OR SHANK)** holds presser foot.
15. **STITCHING GUIDELINES** are used as a visual reference for guiding fabric straight while sewing. The first line is 3/8" (10mm) from center needle position. The most popular seam allowance measurements are 1/2" (13mm) and 5/8" (16mm). The 1/2" seam allowance is the 2nd line, and the 5/8" seam allowance is the 3rd line from center needle position.

# 1

## ABOUT YOUR MACHINE

### Removable Storage Compartment and Accessories

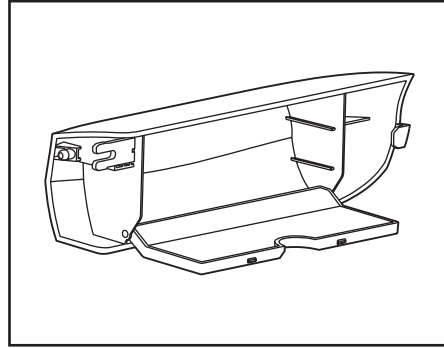
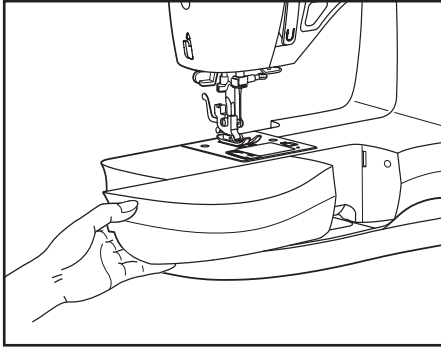

Hold the Removable Storage Compartment horizontally, then pull toward the left to remove it from the machine. Doing this, you will have access to the free arm, which makes it easy to sew tubular projects like pant hems or sleeves. Additionally, you will find the machine's accessories stored here (See Page 11).

To replace the Removable Storage Compartment, hold it as shown in the illustration, and then push it to the right.

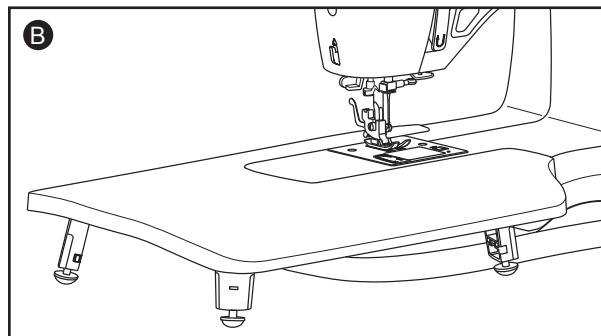
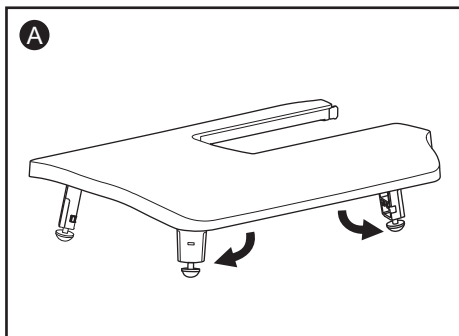

The extension table provides additional sewing space when sewing bulky items.

To install, extend the legs as indicated in photo (A).

Remove the storage compartment and slip the table onto the free arm (B).

Extension table rubber feet can be adjusted by turning left or right to ensure that the table is level for the surface on which you are sewing.

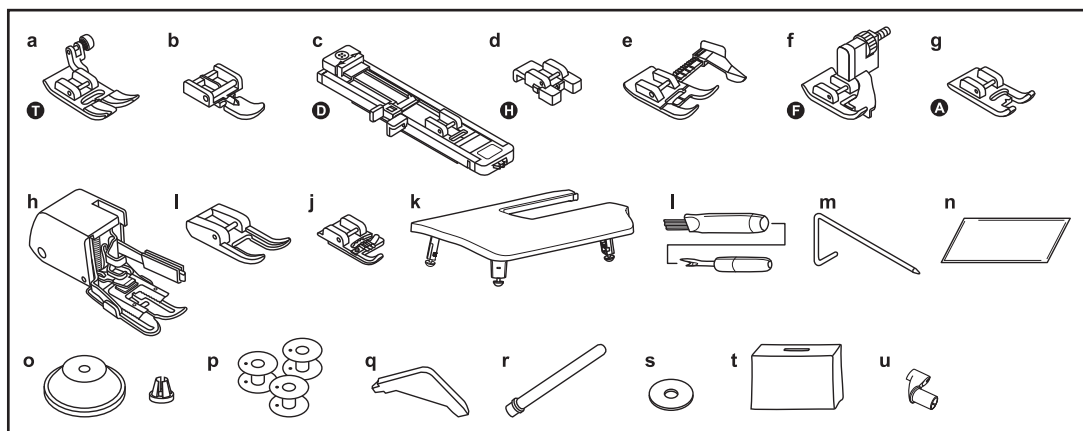

This machine comes with a standard assortment of presser feet and accessories. Most accessories are located in the storage compartment. The Even Feed Foot can be found in the Styrofoam that holds the Extension Table.

### Standard Accessories Included:

- a. All Purpose Foot (for general sewing)
- b. Zipper Foot (for inserting a zipper)
- c. Buttonhole Foot (for making buttonholes)
- d. Button Sewing Foot (for attaching buttons) (\* This foot may be optional with machines sold in some areas)
- e. Sew Easy Foot (for sewing accurate seams) (\* This foot may be optional with machines sold in some areas)
- f. Blind Hem Foot (for sewing a blind hem)
- g. Satin Stitch Foot (for satin stitches and other decorative stitches)
- h. Even Feed Foot (for even feeding of plaid, velvet and other napped fabrics) (\* This foot may be optional with machines sold in some areas)
- i. Open Toe Foot (for satin stitches and other embellishments) (\* This foot may be optional with machines sold in some areas)
- j. Cording Foot (for decorative cord application) (\* This foot may be optional with machines sold in some areas)
- k. Extension Table (provides a larger level sewing surface). Remove the storage compartment to connect the table to the machine.
- l. Seam Ripper/Brush (remove stitches/brush out lint)
- m. Edge/Quilting guide (for straight & accurate quilting) (\* This guide may be optional with machines sold in some areas)
- n. Pack of Needles (replacement needles)
- o. Spool Holders (2 sizes for various thread spool styles)
- p. Bobbins (Class 15 transparent bobbins)
- q. L-Screwdriver (to remove needle plate for cleaning)
- r. Second Spool Pin (for sewing with an optional twin needle)
- s. Spool Pin Felt (to cushion the spool of thread when using the second spool pin)
- t. Soft Cover (to protect your machine from dust and lint while not in use)
- u. Stitch Chart Holder (holds the Stitch Pattern Chart for easy viewing)

### Optional Accessories:

Some of the presser feet listed above may not be included with machines sold in certain areas. If these presser feet were not included with your machine, they may be purchased separately. See the Optional Accessories information below.

For information about additional presser feet, attachments and accessories that may be available for your machine, visit [www.singerco.com](http://www.singerco.com).

# 2

## GETTING READY TO SEW

### Powering Your Machine

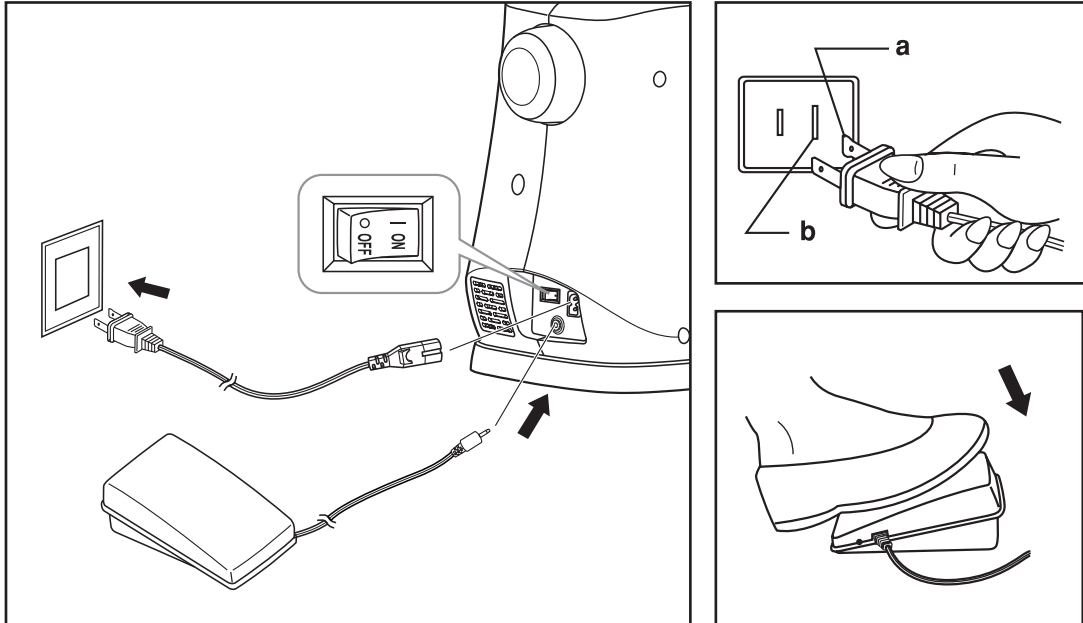

Connect the machine to a power source as illustrated. This machine is equipped with a polarized plug which must be used with the appropriate polarized outlet. (a and b)

⚠ Unplug power cord when machine is not in use.

#### Foot Control

The foot control regulates the sewing speed. When foot control is disconnected, use the Start/Stop Button to operate the machine.

#### Sewing Light

Press main switch from OFF(o) to ON (-) for power and light.

⚠ For machine with a polarized plug (one blade is wider than the other). To reduce the risk of electric shock, this plug is intended to fit in a polarized outlet only one way. If it does not fit fully in the outlet, reverse the plug. If it still does not fit, contact a qualified electrician to install the proper outlet. Do not modify the plug in any way.

⚠ Your SINGER® machine is adjusted to provide the best stitch results at normal room temperature. Extreme hot and cold temperatures can affect the sewing results.

⚠ After switching off, residual power may still remain in the machine. This may cause the light to stay on for a few seconds while the power is consumed. This is normal behavior for an energy efficient appliance.

# GETTING READY TO SEW

## Winding the Bobbin

2

➔ This machine uses Class 15 transparent bobbins. Use only this style of bobbin when purchasing additional bobbins for your machine. Do not substitute with metal bobbins.

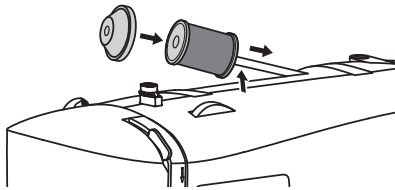

1. Place thread spool and corresponding size spool holder onto spool pin. Spool holder should be large enough to cover the end of the thread spool so thread unreels smoothly. For smaller, narrower spools, use the small spool cap, which can be found in the removable storage compartment.

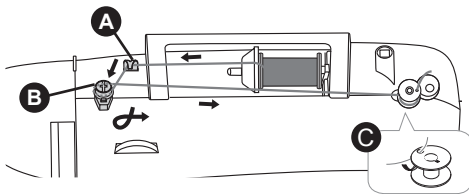

2. (A) Snap thread into guide at top of machine. (B) Place thread snugly around bobbin winding tension disk to ensure that thread winds onto bobbin smoothly and consistently. (C) Thread bobbin as shown, then place it onto the bobbin winding spindle.

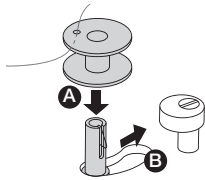

3. Check that bobbin is pushed down firmly (A). If it is not, the thread could begin winding under the bobbin. Push the bobbin and spindle firmly to the right (B). When the bobbin winding spindle is pushed to the right, the symbol "⊗" appears on the LCD screen.



4. Hold the thread end to get ready to wind. Step on the foot control gently or press the Start/Stop Button as you hold the thread end. Allow it to wind a few revolutions slowly, then remove your foot from the foot control or press the Start/Stop Button to stop.

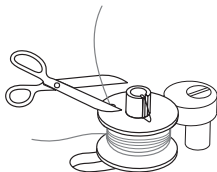

5. Trim the thread end close to the top of the bobbin, then resume winding by stepping on the foot control or pressing the Start/Stop Button.

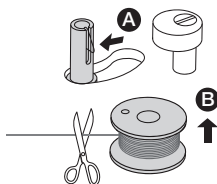

6. The bobbin will stop winding when it is full. Lift your foot off the foot control or press the Start/Stop Button. Push the bobbin to the left (A), then trim the thread and remove the bobbin from the spindle (B).

➔ When the bobbin winding spindle is pushed to the right, the machine will NOT sew. Make sure to push the bobbin winding spindle back to the left once bobbin winding is complete.

# 2

## GETTING READY TO SEW

### Inserting the Bobbin

⚠ Turn power switch off before inserting or removing the bobbin.

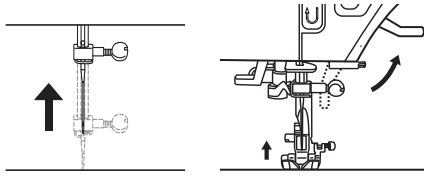

1. When inserting or removing the bobbin, the needle and presser foot must be fully raised.

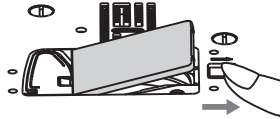

2. Push the bobbin cover release button to remove the bobbin cover plate. Remove the empty bobbin.

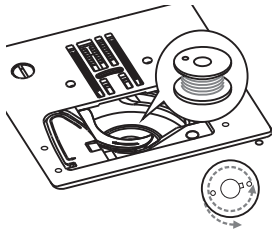

3. Insert the wound bobbin in the bobbin case with the thread running in a counterclockwise direction (arrow).

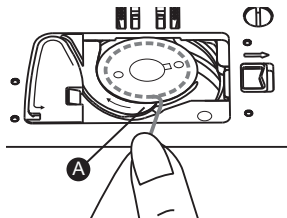

4. Pull the thread through the slit (A).

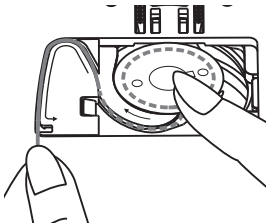

5. With a finger held gently on top of the bobbin, place thread firmly into guides as shown.

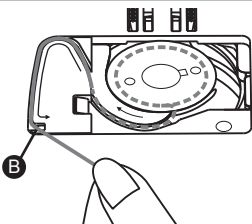

6. To cut off excess thread pull it toward you to cut it with the cutter at point (B). Replace the bobbin cover plate.

# GETTING READY TO SEW

## Threading the Upper Thread

2

⚠ For safety, turn off the power before threading the machine.

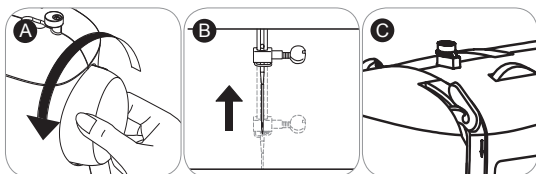

1. Start by turning the handwheel (A) toward you to raise the needle (B) and the thread take up lever (C). You should be able to see the take up lever.

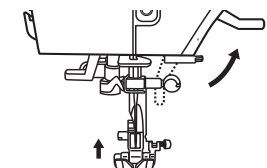

2. ➡ **Raise the presser foot lifter.** This is necessary in order for the machine to be threaded correctly.

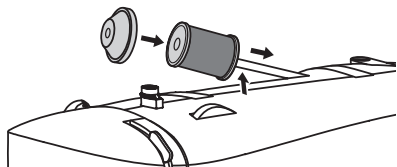

3. Place the thread spool and spool cap onto the spool holder.

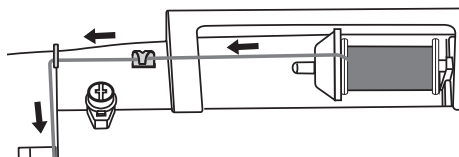

4. Draw thread from the spool through the two pre-tension guides at the top of the machine (see page 8). Hold the thread with both hands and pull it into each of the guides.

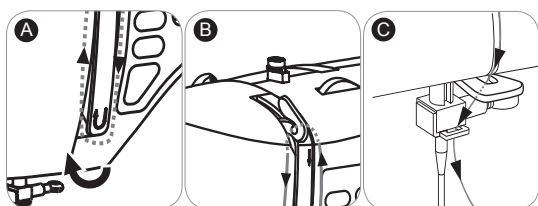

5. (A) Bring the thread down the right channel, around the U-turn, and up the left channel. (B) At the top of the left channel, slip the thread from back to front through the slotted eye of the thread take-up lever. If the thread does not pass into the eye of the take-up lever, the machine will jam when you start to sew. After threading the take-up lever, bring the thread downward again. (C) Pass the thread behind the metal thread guides and then down to the needle.

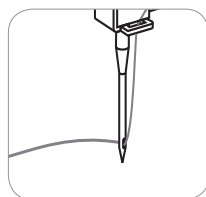

6. If you want to thread the needle manually, thread it from front to back. Pull about 6-8 inches of thread to the back beyond the needle eye. Alternatively, you can use the automatic needle threader to thread the eye of the needle. (see page 16)

# 2

## GETTING READY TO SEW

### Automatic Needle Threader

⚠ For safety, turn off the power before using the automatic needle threader.

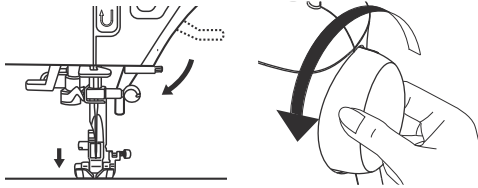

1. Lower the presser foot lifter. Raise the needle to its highest position by turning the handwheel toward you. If you turn the handwheel backward, the machine will jam when you start to sew.

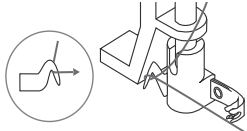

2. Pass thread around thread guide.

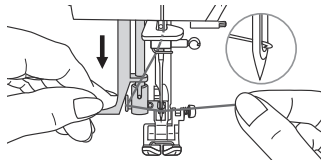

3. Press lever down as far as it will go. The threader automatically swings to the threading position.

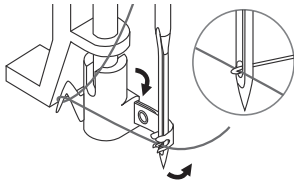

4. Pass the thread in front of the needle and under the hook.

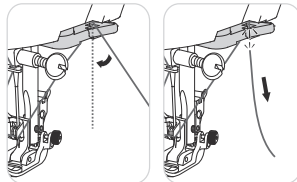

5. To cut the excess thread, take thread tail and gently slip it over the thread cutter located to the right of the needle.

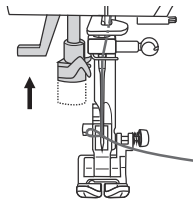

6. Release the lever & the thread tail at the same time, this will form a loop at the back of the needle.

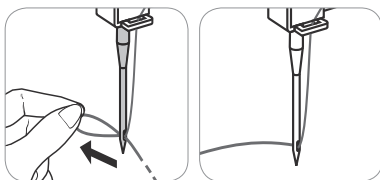

7. Pull the thread through the needle eye. While holding the thread, raise the presser foot lifter and pull the thread under the foot toward the back.

➡ Pull about 6-8" of thread to the back beyond the eye of the needle. This will help prevent the needle from becoming unthreaded when you start to sew.



# GETTING READY TO SEW

## Drawing Up the Bobbin Thread

2

⚠ For safety, turn off the power before threading the machine.

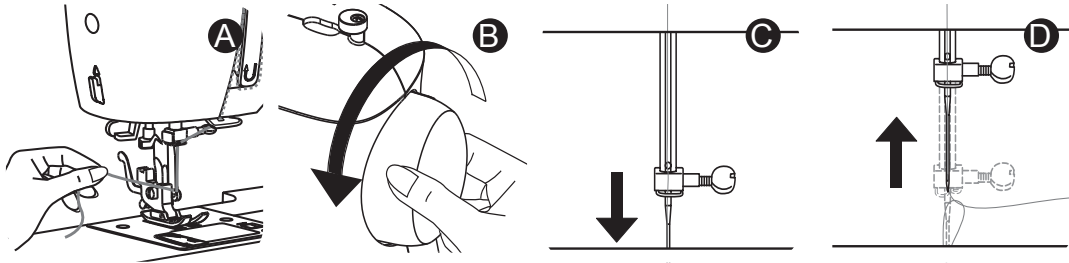

1. Hold the upper thread tail with the left hand (A). Turn the handwheel toward you (B), first lowering (C) and then raising the needle (D).

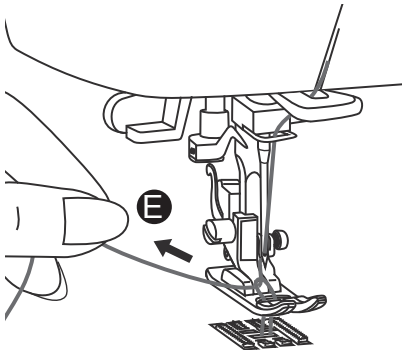

2. As you turn the handwheel, gently pull the upper thread, which will bring a loop of the bobbin thread up through the hole of the needle plate (E). Pull the loop to bring the bobbin thread end up through the opening in the needle plate. If a loop doesn't pull up, turn the handwheel toward you one more time. If it still doesn't come up, check that the bobbin thread is not trapped by the bobbin cover.

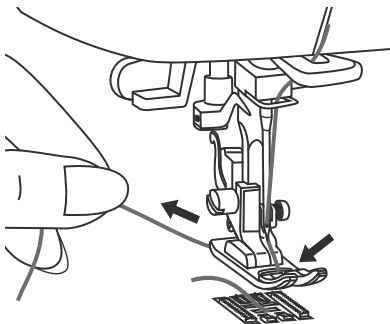

3. Bring both threads under the presser foot and toward the back of the machine.

# 3

## START SEWING

### Before You Start Sewing

Now that your machine is threaded, we will show how to set up the machine for basic sewing techniques such as: sewing a straight stitch, sewing a decorative stitch, sewing a stretch stitch, sewing a buttonhole and sewing a button. With each technique, you have the opportunity to sew along.

For more information about the various stitches on your machine and how to use them, refer to the **Stitch Reference Guide** by visiting [www.singerco.com](http://www.singerco.com).

Here are a few other tips that you may find helpful before you begin:

When unpacking the machine, you may have noticed some small traces of oil around the needle plate or presser foot area. If so, wipe off any excess oil with a soft, dry cloth before you start sewing. It is also recommended that you sew on a piece of scrap fabric to remove excess oil.

The Speed Control Adjustment Lever is used to control the speed of your machine. This is the case whether you are using the Foot Control or the Start/Stop Button to start sewing. To increase the sewing speed slide the lever to the right, to reduce the speed slide the lever to the left. When you remove your foot from the foot control or you press the Start/Stop Button the machine will stop sewing.

Needles are an important part of sewing. Using old, damaged or incorrect needles for your projects can affect sewing results. For information about which needle to use for your project, refer to the Stitch Reference Guide at [www.singerco.com](http://www.singerco.com). For information on how to change the needle, see page 28.

Depending on the sewing technique you want to do, it may be necessary to change to a different presser foot. For information on how to do this, see page 29.

Review the page about Stitch Formation (See Page 19). This will help you understand what the stitching should look like when you sew.

Use the thread cutter on the machine (See Page 7) to trim thread tails when finished sewing. This is helpful because thread tails are left long enough so that the needle does not become unthreaded when you start sewing again.

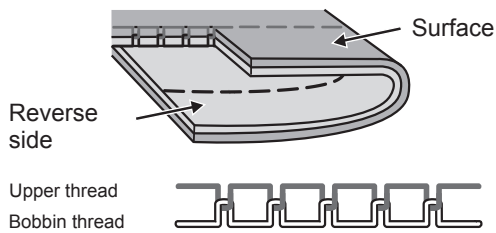

### 1. How Stitches Form

Stitches are formed when the upper thread and the bobbin thread interlock between the fabric layers. Stitching is well balanced when the needle thread appears on the top and the bobbin thread appears on the bottom.

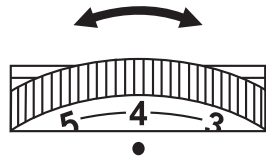

### 2. Thread Tension Dial

The Thread Tension Dial has a range of settings between 0 and 9. Most of your sewing will be done with your Thread Tension Dial set between 3 and 5. It can be adjusted to a higher number for more tension on the upper thread, if the upper thread seems too loose. It can be adjusted to a lower number for less tension on the upper thread, if the bobbin thread seems to be showing on the top side of the fabric.

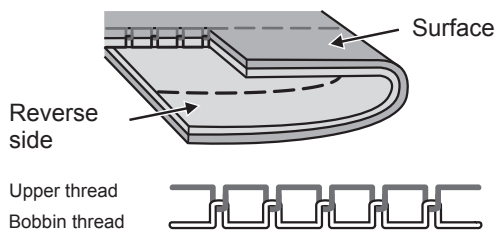

### Adjusting Tension

Thread tension can also be adjusted for various sewing techniques. For basting (see Appendix), you can loosen it to a lower number so that the stitches can easily be removed. For gathering, you can turn it to a higher number.

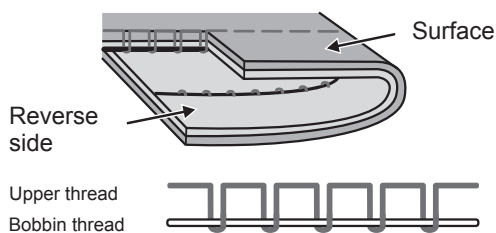

➔ When you sew, if you see large loops on the underside of the fabric, this is actually an indication that the upper thread was not threaded correctly, as it has no tension controlling it. For information on how to correct this, see the Troubleshooting and Maintenance section of this manual.

# 3

## START SEWING

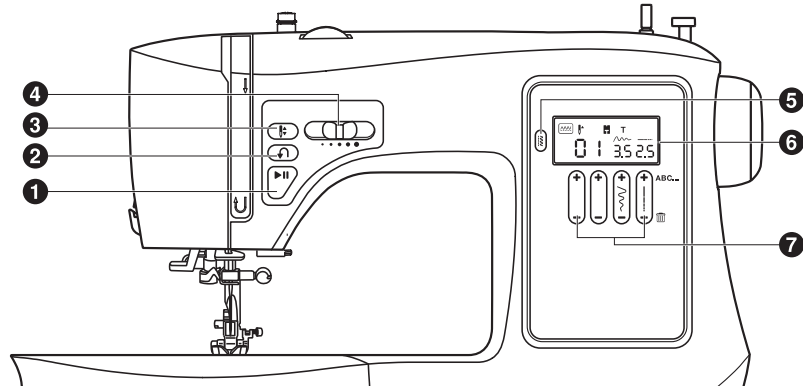

### Operation Buttons and Function Buttons



#### A. Operation Buttons

1. **Start/Stop Button**  
Press this button to start or to stop the machine when the foot control is not being used.
2. **Reverse Button**  
Hold down this button to sew stitches in reverse at the start and at the end of a seam, as well as most stitch patterns. The Reverse Button is also used for saving characters from the ABC Mode. (See Page 21)
3. **Needle Up/ Needle Down Position Button**  
Press this button to move the needle to either the up or the down position. Needle will be programmed to stop in selected position until the button is pressed again.
4. **Speed Control Adjustment Lever**  
Slide this lever to the left to slow the machine and to the right to increase the speed of the machine.

#### B. Function Buttons

5. **Mode Button**  
Allows you to toggle between the three mode selections: , , .
6. **LCD Screen**  
Displays instructions pertaining to the stitch you have selected.
7. **Function Buttons**  
Control stitch number selection, as well as the width and the length of the stitches.

## LCD Screen

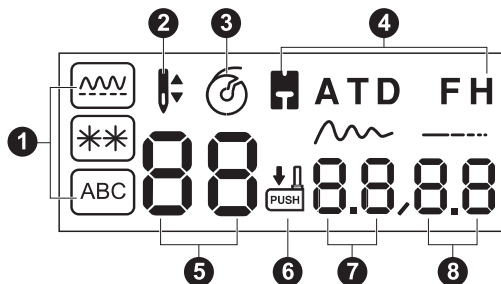

1. Mode indicator
2. Needle up/down
3. Bobbin winding indicator
4. Presser foot indicator
5. Stitch number
6. Buttonhole lever indicator
7. Stitch width
8. Stitch length



# 3

## START SEWING Stitch Selection

### A. Utility Stitch Patterns

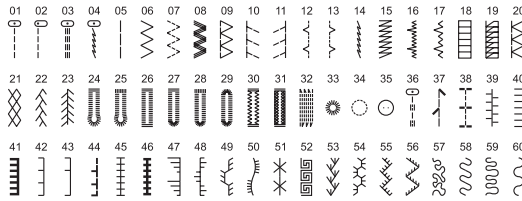

### B. Decorative Stitch Patterns

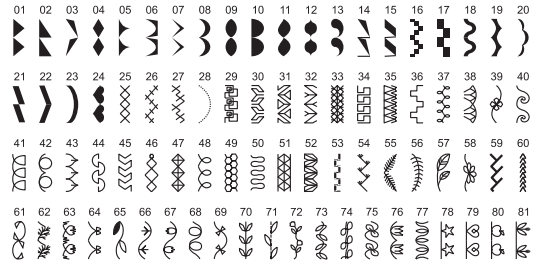

For examples of other stitch patterns and further instruction, see the Stitch Reference Guide at [www.singerco.com](http://www.singerco.com).

#### Choosing Utility and Decorative Stitch Patterns:

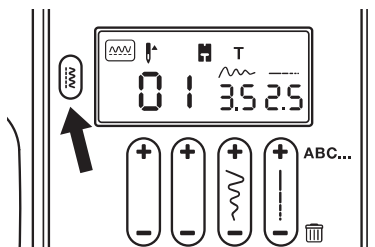

The machine will automatically default to the Pattern Mode and Straight Stitch when turned on. You can also select the mode for additional decorative stitches or the mode for Alpha-Numeric Stitch Patterns.

Choose the mode and then press the two left + or - Pattern Adjustment Buttons to select the number of the stitch that you desire.

#### Adjusting the Width or the Length of the Stitch:

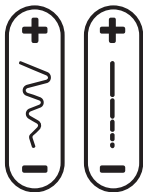

The machine will automatically default to a preset stitch width and stitch length for optimum results. These settings are displayed on the LCD screen.

You can adjust the width or the length of most stitches by toggling between the Stitch Width and the Stitch Length Buttons. The button on the left controls the width and the button on the right controls the length.

1. To increase the width of the stitch press the + button, and to decrease the width of the stitch, press the – button. When Utility Stitch Patterns 01 to 05 are selected, the needle position is regulated by the Stitch Width Adjustment Button. Pressing – will move the needle to the left and pressing + will move the needle to the right. On 3.5 the needle is positioned in the center for straight stitch.
2. To increase the length of the stitch press the + button and to decrease the length of the stitch, press the – button.

✓ The stitch width can be adjusted to 7.0 for most stitches. Some stitches have a limited stitch width.

✓ The stitch length can be adjusted from 0.0 to 4.5 for most stitches. Some stitches have a limited stitch length.

# START SEWING

## Sewing a Straight Stitch

3

Mode Button and Function Buttons

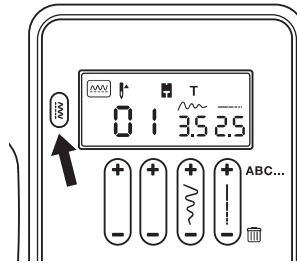
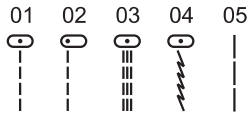

A straight stitch is used for sewing seams and topstitching.

### HOW TO:

1. Set the machine to Straight stitch. The machine will automatically default to straight stitch when it is turned on. (See Page 22)
2. The Stitch Length can be set at the stitch length that you desire. (See Page 22)
3. The Stitch Width can be set at either 0.0 or 3.5 depending on the needle position. (See Page 22)

### SEW ALONG:

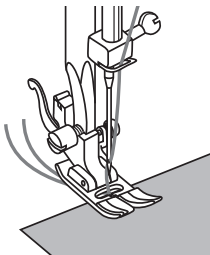
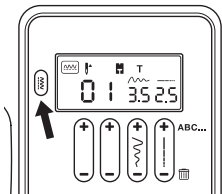

1. Set Mode Button to and choose Straight Stitch number 01. Your machine will automatically default to stitch 01 when you power it on.
2. Set the Stitch Length to 2.5. This is an average stitch length setting for regular sewing. Your machine will automatically default to a stitch length of 2.5, you can shorten or lengthen the stitch if you desire using the Stitch Length Function Button.
3. Set the Stitch Width to 3.5. Your machine will automatically default to a Stitch Width of 3.5 when you power it on. This will position the needle in the center. Use the Stitch Width Button to move the position of the needle.
4. Place the fabric under the All Purpose Foot or the Sew Easy Foot (See Page 30) with the right-hand edge of the fabric lined up with the desired seam guide line on the right side of the needle plate. Lower the presser foot, then step on the Foot Control or press the Start/Stop Button to begin sewing. Always make sure that the presser foot is lowered before you begin to sew. If you fail to do so, the machine will jam as you begin to sew. Start your seam by sewing 2 to 3 stitches. Press and hold the Reverse Button to sew backwards 2 to 3 stitches, which will lock the end of the seam so the stitches don't come undone. Release the Reverse Button to sew forward again. Continue sewing the length of the seam. Press and hold the Reverse Button at the end of the seam and sew backwards 2 to 3 stitches. Release the Reverse Button to sew forward again to finish.

- ✓ Use a slightly shorter stitch length for lightweight fabrics, finer threads and needles. Use a longer stitch length such as 3 or 4 for heavy weight fabrics.
- ✓ It may be helpful to gently hold the thread tails with your left hand for the first few stitches, as this will help guide the fabric under the foot as you begin to sew.
- ✓ For sewing heavy weight fabrics, use the Lock In Place Button on the presser foot. (See Page 30)

# 3

## START SEWING

### Sewing a Decorative Stitch

Mode Button and Function Buttons

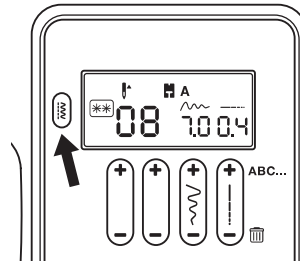
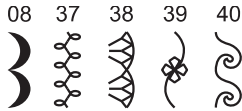

A decorative stitch is used for embellishing and adding flair to your sewing projects. (Go to [www.singerco.com](http://www.singerco.com) to view other decorative stitches that can be used).

#### HOW TO:

1. Set the machine to the desired stitch by entering the number of the desired stitch. (See Page 22)
2. Set the Stitch Length between 0.4 and 1.0. (See Page 22)
3. Set the Stitch Width between 2.0 and 7.0. (See Page 22)

#### SEW ALONG: Scallop Stitch

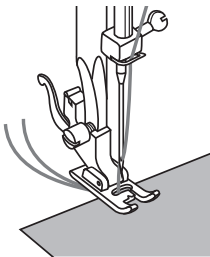
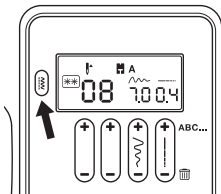

1. Set the Mode Button to and select stitch number 08.
2. The LCD screen on your machine displays the foot that is recommended for the stitch selected. Remove the All Purpose Foot and attach the Satin Foot (A). (See Page 29)
3. Set the Stitch Length to number 0.4. Your machine will automatically default to a stitch length of 0.4 when you select stitch # 08.
4. Set the Stitch Width to 7.0. Your machine will automatically default to stitch width 7.0 when you select stitch # 08.
5. Place the fabric under the presser foot with the right-hand edge of the fabric lined up with the desired seam guide line on the right side of the needle plate. Lower the presser foot, then step on the Foot Control or press the Start/Stop Button to begin sewing. Sew 2 to 3 stitches and then backstitch (See Page 23) to reinforce the seam.

- ✓ Use a stabilizer (see Appendix) on the underside of the fabric if there is gathering or puckering as you sew. Decorative stitching can be used almost anywhere on your project!
- ✓ It may be helpful to decrease the upper tension by 1 or 2 numbers when sewing decorative stitches. This will help prevent the bobbin thread from possibly showing on the top when sewing denser stitches.



# START SEWING

## Sewing a Stretch Stitch

3

### Mode Button and Function Buttons

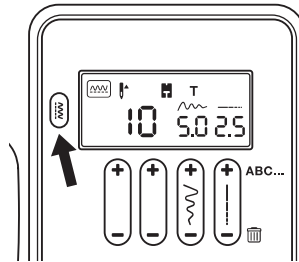
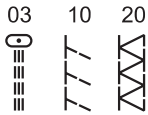



A stretch stitch is used for stretch knit fabrics. This type of seam will stretch with the fabric. (Go to [www.singerco.com](http://www.singerco.com) to view other stretch stitches that can be used).

#### HOW TO:

1. Set the machine to the desired stitch by entering the number of the desired stitch. (See Page 22)
2. Set the Stitch Length between 0.5 and 4.5. (See Page 22)
3. Set the Stitch Width between 0.0 and 7.0. (See Page 22)

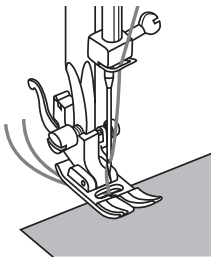
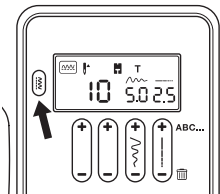
#### SEW ALONG: Overedge Stitch



1. Set the Mode Button to  and select stitch number 10.
2. Set the Stitch Length to number 2.5. Your machine will automatically default to stitch length 2.5 when you select stitch # 10.
3. Set the Stitch Width to 5.0. Your machine will automatically default to stitch width 5.0 when you select stitch # 10.
4. Place the fabric under the All Purpose Foot with the right-hand edge of the fabric lined up with the desired seam guide line on the right side of the needle plate. Lower the presser foot, then step on the Foot Control or press the Start/Stop Button to begin sewing.

# 3

## START SEWING

### Sewing a 1-Step Buttonhole

Mode Button and Function Buttons

26

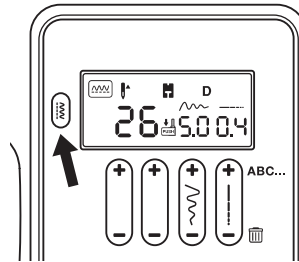





This machine has built-in buttonholes, allowing you to sew buttonholes in one easy step. The buttonhole stitches are numbered 24 to 31.

#### HOW TO:

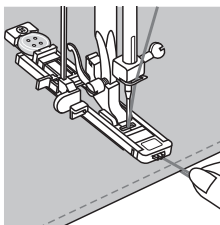
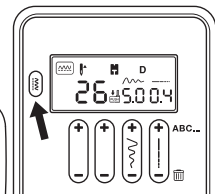
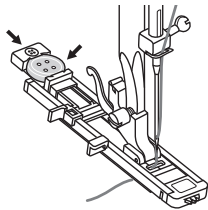
1. Set the machine to the desired stitch by entering the number of the desired buttonhole stitch. (See Page 22)
2. The Stitch Length is automatically selected by the machine for optimum results. (See Page 22)
3. The Stitch Width is automatically selected by the machine for optimum results. (See Page 22)

#### SEW ALONG: Buttonhole Stitch



1. Place the button at the back of the buttonhole foot. Mark position and length of buttonhole on the fabric.
2. Remove the All Purpose Foot and attach the Buttonhole Foot (See Page 29). Pass upper thread through the hole of the foot and bring thread to the left.
3. Set the Mode Button to  and select stitch number 26, the LCD screen will display the figure  , to remind you to lower the Buttonhole Lever.
4. Set the Stitch Length to number 0.4. Your machine will automatically default to stitch length 0.4 when you select stitch # 26.
5. Set the Stitch Width to 5.0. Your machine will automatically default to stitch width 5.0 when you select stitch # 26.
6. Place the fabric under the foot so that the center line mark on your fabric is aligned with the center of the Buttonhole Foot and that the cross line mark on the fabric aligns with the center hole of the Buttonhole Foot. Lower the presser foot.
7. Pull the Buttonhole Lever all the way down and then carefully push it back. The Buttonhole Lever must sit behind the bracket located on the left of the Buttonhole Foot.
8. Hold upper thread slightly and start to sew until the buttonhole is completed.
9. Return the Buttonhole Lever to its original position once all buttonholes are completed.

- ➔ Use a stabilizer to support the stitches.
- ➔ Slightly reducing your upper tension by 1 or 2 numbers will improve results.
- ➔ Always test sew on a scrap piece of your fabric.
- ➔ The density of the buttonhole can be adjusted by using the Stitch Length Adjustment Button.

# START SEWING

## Sewing a Button

3

Mode Button and Function Buttons

35

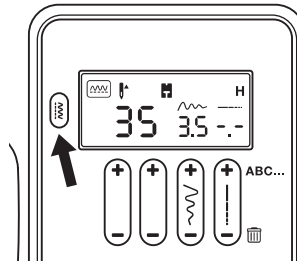



This machine includes a Button Sewing Foot, allowing you to attach buttons to your projects easily and quickly.

### HOW TO:

1. Set the machine to Straight Stitch by entering the stitch number 35. (See Page 22)
2. Set the Stitch Width to 3.5. Your machine will automatically default to stitch width 3.5 when you select stitch # 35. (See Page 22)

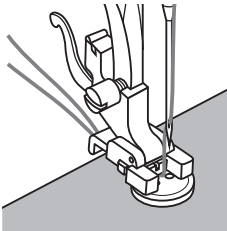
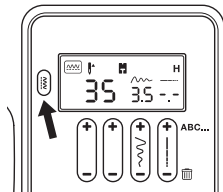
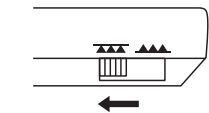
### SEW ALONG: Attaching a Button



1. Disengage (drop) the feed teeth by moving the Drop Feed Lever to the  setting. (See Page 8)
2. Remove the All Purpose Foot and attach the Button Sewing Foot. (See Page 29).
3. Set the Mode Button to  and select stitch number 35.
4. It may be necessary to adjust the stitch width between 2.5 and 4.5 according to the distance between the two holes of the button. Adjust the width by pressing the + or the - side of the Stitch Width Button.
5. Place the fabric and the button under the Button Sewing Foot and lower the presser foot. Turn the handwheel slowly to check that the needle goes cleanly into the left and right holes of the button. Adjust the Stitch Width if necessary.
6. Start to sew at low speed. The sewing machine automatically stops after sewing reinforcement stitches. To add stability to the button stitching repeat step 6 as necessary.
7. Pull the upper thread at the end of the stitching to the wrong side of the fabric using a hand sewing needle, and then tie off loose threads at the back of the fabric.

- ☑ Slide the Drop Feed Lever back to the  position when button sewing is completed. Turn the handwheel toward you to raise the feed teeth.

# 3

## START SEWING

### Inserting and Changing Needles

⚠ Turn the machine off before changing the needle.

Change the needle regularly, especially if it is showing signs of wear resulting in sewing problems. Needles can show signs of wear when you see snags in the fabric or hear a slight popping sound as you are sewing. If the needle becomes bent (A), the point becomes damaged (B) or the needle becomes dull (C), you should replace it with a new needle and discard the old one.

Generally, the needle should be replaced after every 4 projects or approximately every 16 hours of sewing time.

It is also important to use the right needle for the fabric you are sewing. (Go to [www.singerco.com](http://www.singerco.com) to view the Stitch Reference Guide) For best results, use SINGER® branded needles in your SINGER® sewing machine.

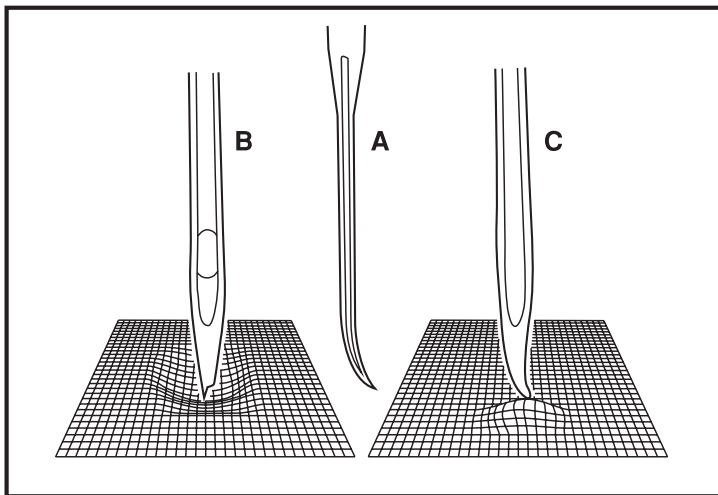

Loosen the needle clamp screw (A) by turning the screw toward you. Remove and discard the old needle.

Insert the new needle, making sure that the flat side of the top part of the needle is facing the back of the machine (B).

Insert the new needle as far up as it will go (C and D).

Tighten the needle clamp screw (A) securely by turning it toward the back.

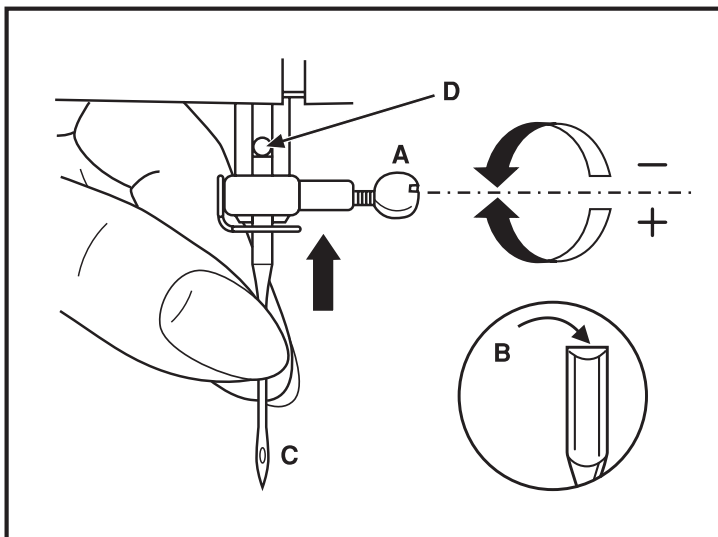

## Changing the Presser Foot

⚠ For safety, turn off the power before changing the presser foot.

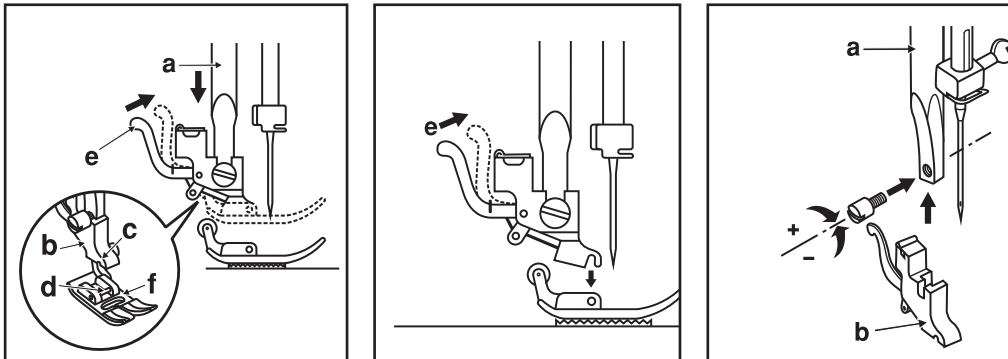

Before changing the presser foot, raise the presser foot lifter.

The presser foot holder (b) is attached to the presser bar (a). The presser foot (f) has a presser foot pin (d) that connects to the presser foot holder, sometimes called a shank (b). The shank has a groove (c) on its underside, which connects it to the presser foot.

To remove a presser foot from the shank, press the lever (e) at the back of the shank. The foot will release. To attach a presser foot, line up the presser foot pin (d) underneath the groove (c) on the shank (b). Lower the presser foot lifter, bringing the shank's groove down over the pin. The foot will snap on.

Some optional presser feet require you to remove the shank from the machine. To remove the shank from the machine (see above) loosen and remove the screw that holds the presser foot onto the presser bar (a), then remove the shank (b). To replace the shank, set the shank onto the presser bar, then replace the screw.

➔ This machine has a low shank with snap-on presser feet. When shopping for optional presser feet and attachments for your machine, look for low-shank, snap-on style.

## Two-Step Extra Presser Foot Lift

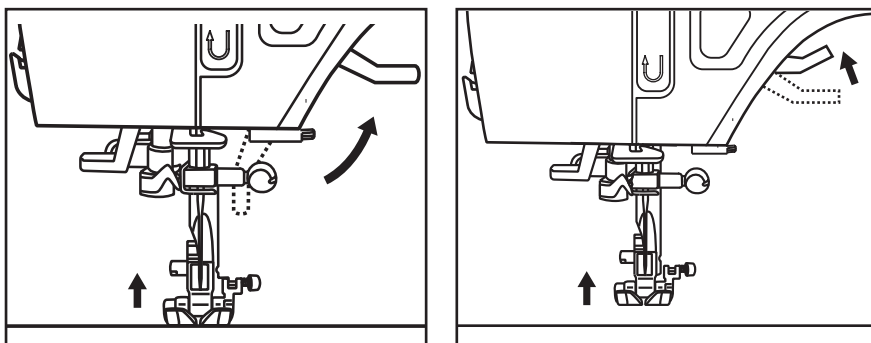

Your machine is equipped with a two-step presser foot lifter.

1. The Presser Foot Lifter raises and lowers the presser foot.
2. When sewing several layers of fabric or heavy fabric, the presser foot can be raised to a second level for easier positioning of the fabric.
3. When raised to the first level, the clearance is 1/4 inch (6 mm), when raised to level 2, the clearance is 5/8 inch (9 mm).

# 3

## START SEWING

### Sew Easy Foot

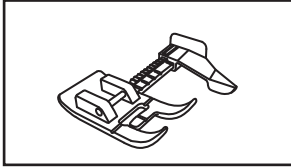

Your machine may include the Sew Easy Foot.

The Sew Easy Foot has a guide to help you sew the most accurate seams every time. The foot has an extension marked with the most popular seam allowances and a movable fabric guide that can be set wherever you want for the project you are making.

1. Attach the Sew Easy Foot.
2. Select Straight Stitch.
3. With your needle set in the center position, use the guide to select 3/8", 1/2", 5/8", 3/4", and even 1" seam allowances.
4. Place your fabric under the foot, lining up the raw edges with the guide on the foot. Lower the presser foot lifter, then sew.

### Edge/Quilting Guide

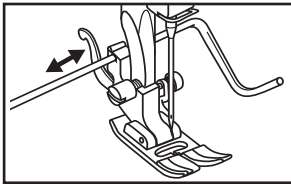

Your machine may be equipped with an Edge/Quilting Guide.

To attach the guide slip it into the slot as illustrated. Adjust the position depending on the technique you are doing.

### Lock in Place Button

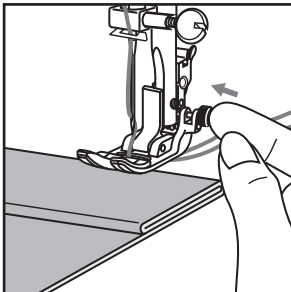

For even feeding when sewing over thicker seams, push in the black button located on the right hand side of the All Purpose Foot (T).

As you approach the thicker seam and the front of the presser foot begins to raise over the thickness, lower the needle into the fabric by turning the handwheel toward you.

Raise the presser foot, and push in the black button as you lower the presser foot, this will lock the foot in a horizontal position.

The black button will release automatically after you sew a few stitches over the seam.

### Blind Hem Foot

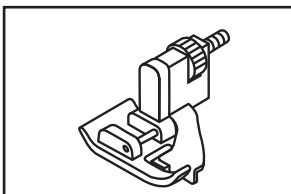

To sew a Blind Hem select Utility Stitch number 12 for woven fabrics and Utility Stitch number 17 for stretch fabrics.

1. Attach the Blind Hem Foot (F).
2. Select the Blind Hem Stitch.
3. Place your folded hem under the foot and sew the seam.

Go to [www.singerco.com](http://www.singerco.com) for more information on sewing a Blind hem.

## START SEWING

### Even Feed Foot

3

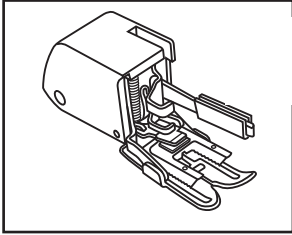

Your machine may include an Even Feed Foot.

Use this foot for sewing plaids, stripes and other napped fabrics such as velvet and corduroy. The Even Feed Foot equalizes the feeding of the fabric layers.

1. Attach the Even Feed Foot to the shank of the machine. Make sure that the extension arm sits on top of the needle clamp screw when attaching the foot to the shank.
2. Set the machine to Straight Stitch number 01 and begin to sew.

## Open Toe Foot

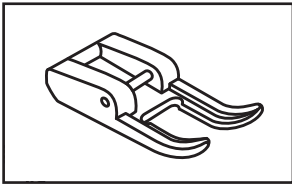

Your machine may include an Open Toe Foot.

It can be used for decorative embellishment. Because the front of the foot is open, it allows a better view of the sewing area.

1. Attach the Open Toe Foot.
2. Set the machine to the desired decorative stitch and begin to sew.

## Cording Foot

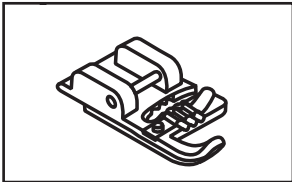

Your machine may include a Cording Foot.

This foot is designed to apply fine cords as decorative embellishment. Use a Zig Zag stitch (Utility Stitch number 06) or a Multistitch Zig Zag stitch (Utility Stitch number 07) to apply the cord.

1. Attach the Cording Foot.
2. Slip one to 3 cords from right to left into the grooves at the top of the foot. Knot the ends of the cords and slip under the foot and to the back about 2 inches (5 cm).
3. Select the stitch, adjust the width if necessary and begin to sew.

## Zipper Foot

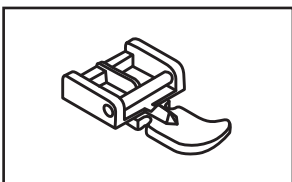

Your machine includes a Zipper Foot.

It is used with a Straight Stitch to apply centered and lapped zippers.

1. Attach the Zipper Foot.
2. Attach the left side of the Zipper Foot when sewing the right side of the zipper.
3. Attach the right side of the Zipper Foot when sewing the left side of the zipper.

Go to [www.singerco.com](http://www.singerco.com) for more information on zipper applications.

## Troubleshooting

1. Thread Loops on Underside of Fabric
2. Bobbin Thread Showing on Top of Fabric
3. Upper Thread Breaking
4. Thread is Shredding
5. Thread Bunching at Beginning
6. Skipping Stitches
7. Bobbin Winding Difficulties
8. Bobbin Thread Breaking
9. Needles Breaking
10. Stitches Distorted
11. Fabric Puckers
12. Fabric Is “Tunneling” Under Stitches
13. Machine Not Feeding Fabric
14. Needle Threader Not Working
15. Loud Noise When Sewing
16. Machine Will Not Run

### 1. THREAD LOOPS ON UNDERSIDE OF FABRIC

**Possible Cause:** Thread looping on the underside of the fabric is always an indication that the upper thread is not correctly threaded. This happens when the upper thread is not correctly placed in the tension mechanism and has not been threaded through the take up lever.

**Solution:** Rethread machine, making sure to first raise the presser foot lifter before starting to thread, so thread can be properly seated in the tension mechanism and take up lever. (See Page 15)

To know if you have rethreaded the machine correctly, try this simple test:

- Raise the presser foot lifter and thread the top of the machine.
- Thread the needle, but don't put the thread under the presser foot yet. As you pull the upper thread to the left, it should pull freely.
- Put the presser foot lifter down. As you pull the upper thread to the left, you should feel resistance. This means you are threaded correctly.
- Put the thread under the presser foot, and then draw up the bobbin thread. Slip both thread tails under the presser foot towards the back. Lower presser foot and begin sewing.

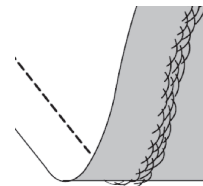

If you put the presser foot lifter down, but the thread still pulls freely (you feel no difference whether the presser foot is up or down), this means you have threaded incorrectly. Remove the upper thread and rethread the machine.

### 2. BOBBIN THREAD SHOWING ON TOP OF FABRIC

**Possible Cause:** Top thread tension too tight.

**Solution:** Reduce upper thread tension. (See Page 19)

**Possible Cause:** Thread path is obstructed, putting extra tension on top thread.

**Solution:** Check that the top thread path is not obstructed and thread is moving freely through the thread path. (See Page 15)

**Possible Cause:** Bobbin thread not in bobbin case tension.

**Solution:** Rethread bobbin. (See Page 14)



### **3. UPPER THREAD BREAKING**

**Possible Cause:** Thread path obstructed.

**Solution:** Check if thread is caught on thread spool (rough spots on the spool itself) or behind spool pin or spool cap (if the thread has fallen behind the spool cap and therefore cannot feed freely through the machine path). (See Page 15)

**Possible Cause:** Machine is not threaded correctly.

**Solution:** Remove upper thread completely, raise presser foot lifter, rethread machine making sure thread is in take-up lever (raise take up lever to its highest position by turning hand wheel toward you). (See Page 15)

**Possible Cause:** Upper tension too tight.

**Solution:** Reduce upper thread tension. (See Page 19)

### **4. THREAD IS SHREDDING**

**Possible Cause:** Thread is old or poor quality.

**Solution:** Rethread the top of the machine and bobbin with good quality thread. (See Page 15)

**Possible Cause:** The needle is either worn or old, or it is the wrong style or size for the thread being used. Though it may seem that the machine is shredding the thread, it is usually the needle causing this. If the needle is old or worn out, or if the needle is too small for the thickness of thread, the eye of the needle can cause the thread to shred.

**Solution:** Change to a fresh needle in the correct size for the thickness/weight of thread being used. (See Page 28)

### **5. THREAD BUNCHING AT BEGINNING**

**Possible Cause:** Top and bobbin threads have not been properly placed underneath presser foot before starting to sew.

**Solution:** Ensure that both the top thread and the bobbin thread are under the presser foot and toward the back before starting to sew. (See Page 23)

**Possible Cause:** Sewing was started with no fabric under the presser foot.

**Solution:** Place fabric under foot, making sure that needle comes down into fabric; lightly hold both thread tails for first few stitches. (See Page 23)

### **6. SKIPPING STITCHES**

**Possible Cause:** Needle inserted incorrectly.

**Solution:** Check that flat side of needle top is toward back of machine and needle is up as far as it can go, then tighten needle clamp screw. (See Page 28)

**Possible Cause:** Wrong needle for fabric sewn.

**Solution:** Use correct style and size of needle for fabric. (Go to [www.singerco.com](http://www.singerco.com) to view the Stitch Reference Guide)

**Possible Cause:** Bent, dull or damaged needle.

**Solution:** Discard needle and insert new needle. (See Page 28)

### **7. BOBBIN WINDING DIFFICULTIES**

**Possible Cause:** Bobbin thread loosely wound on bobbin.

**Solution:** Rewind bobbin, making sure that the thread is placed snugly in the bobbin winding tension disk. (See Page 13)

**Possible Cause:** Bobbin winding spindle not fully engaged, therefore bobbin not winding.

**Solution:** Check that the bobbin winding spindle has been fully engaged before starting to wind. (See Page 13)

**Possible Cause:** Bobbin is winding sloppily because thread end not held at beginning of winding process.

**Solution:** Before starting to wind, hold the thread tail (coming out of the bobbin) securely, allow the bobbin to partially fill, then stop to trim the thread tail close to the bobbin. (See Page 13)

### **8. BOBBIN THREAD BREAKING**

**Possible Cause:** Bobbin threaded incorrectly.

**Solution:** Check that bobbin is placed correctly in the bobbin case. (See Page 14)

**Possible Cause:** Bobbin wound too full or unevenly.

**Solution:** Bobbin thread may not have been correctly placed into bobbin winding tension disk during the bobbin winding process. (See Page 13)

**Possible Cause:** Dirt or lint in bobbin case.

**Solution:** Clean bobbin case. (See Page 37)

**Possible Cause:** Wrong bobbins being used.

**Solution:** Use SINGER® bobbins that are the same style as those that come with the machine – don't substitute. Your machine comes with Class 15 transparent bobbins.

### **9. NEEDLES BREAKING**

**Possible Cause:** Bent, dull or damaged needle.

**Solution:** Discard needle, insert new needle. (See Page 28)

**Possible Cause:** Wrong size needle for fabric.

**Solution:** Insert appropriate needle for fabric type. (Go to [www.singerco.com](http://www.singerco.com) to view the Stitch Reference Guide)

**Possible Cause:** Machine not threaded correctly.

**Solution:** Rethread the machine completely. (See Page 15)

**Possible Cause:** "Pushing" or "pulling" fabric.

**Solution:** Don't manually push/pull fabric in order to sew, but allow the machine's feed teeth to draw fabric under the presser foot as you guide it. (See Page 23)

**10. STITCHES DISTORTED**

**Possible Cause:** “Pushing” or “pulling” the fabric.

**Solution:** Don’t manually push/pull fabric in order to sew, but allow the machine’s feed teeth to draw fabric under presser foot as you guide it.

**Possible Cause:** Incorrect stitch length setting.

**Solution:** Check for correct stitch length setting. (Go to [www.singerco.com](http://www.singerco.com) to view the Stitch Reference Guide)

**Possible Cause:** Stabilizer may be needed for technique.

**Solution:** Place stabilizer underneath fabric. (See Appendix in this manual)

**11. FABRIC PUCKERS**

**Possible Cause:** Top thread tension is too tight.

**Solution:** Reduce the top thread tension. (See Page 19)

**Possible Cause:** Stitch length is set too short for the fabric being sewn.

**Solution:** Increase stitch length. (Go to [www.singerco.com](http://www.singerco.com) to view the Stitch Reference Guide)

**Possible Cause:** Wrong style needle for fabric type.

**Solution:** Use correct needle style. (Go to [www.singerco.com](http://www.singerco.com) to view the Stitch Reference Guide)

**Possible Cause:** Needle too large for fabric.

**Solution:** Change to smaller size needle. (See Page 28)

**12. FABRIC IS “TUNNELING” UNDER STITCHES**

**Possible Cause:** Fabric is not properly stabilized for the density of the stitches. (for example, satin stitch applique)

**Solution:** Add a fabric stabilizer underneath the fabric to help keep the stitches from tunneling in together, forming a puckered ridge in fabric. (See Appendix in this manual)

**13. MACHINE NOT FEEDING FABRIC**

**Possible Cause:** Presser foot lifter has not been lowered onto fabric after threading.

**Solution:** Lower the presser foot lifter before starting to sew. Don’t “push” or “pull” the fabric as you sew.

**Possible Cause:** Feed teeth are lowered.

**Solution:** If the feed teeth have been lowered, they need to be raised to resume regular sewing.

**Possible Cause:** Stitch length is set at zero.

**Solution:** Increase stitch length setting.

**14. NEEDLE THREADER NOT WORKING**

*(for models with built-in automatic needle threader)*

**Possible Cause:** Needle not in correct position.

**Solution:** Raise needle to its highest position by turning hand wheel toward you. (See Page 16)

**Possible Cause:** Needle inserted incorrectly.

**Solution:** Needle all the way up in needle clamp (See Page 28)

**Possible Cause:** Needle is bent.

**Solution:** Remove bent needle, insert new needle. (See Page 28)

**Possible Cause:** Hook pin damaged.

**Solution:** Needle Threader needs replacement; contact authorized SINGER® service center: Visit [www.singerco.com](http://www.singerco.com).

**15. LOUD NOISE WHEN SEWING**

**Possible Cause:** Thread not in take-up lever.

**Solution:** Rethread the machine, making sure the take up lever is in its highest position so thread goes in the eye of the take up lever – turn machine hand wheel toward you to raise the take up lever to its highest position for threading. (See Page 15)

**Possible Cause:** Thread path obstructed.

**Solution:** Check that thread is not caught on the thread spool or behind the spool cap. (See Page 15)

**16. MACHINE WILL NOT RUN**

**Possible Cause:** Bobbin winding spindle is engaged when you try to sew.

**Solution:** Disengage bobbin winding spindle. (See Page 13)

**Possible Cause:** Power cord and/or foot control not plugged in correctly.

**Solution:** Make sure power cord/foot control are correctly seated in machine and power supply. (See Page 12)

**Possible Cause:** Wrong bobbins being used.

**Solution:** Use only SINGER® branded bobbins that are same style as those that come with machine. (See Page 11)

### Cleaning the Feed Teeth and Hook Area

 Before cleaning the machine, disconnect the power supply by removing the plug from the electrical outlet. Turn the hand wheel to raise the needle to its highest position. Raise the presser foot lifter.

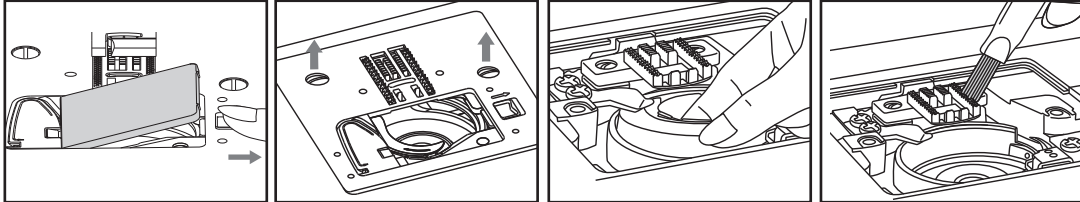

To ensure the best possible operation of your machine, it is necessary to keep the essential parts clean. For daily machine use, it is recommended that you clean the machine weekly.

1. Remove the bobbin cover and then the presser foot by pressing on the lever at the back of the foot. Removing the presser foot will provide better access to the needle plate and bobbin case area.
2. Turn the handwheel towards you until the needle is at the highest position. (The take-up lever should be visible over the top of the machine).
3. Remove the 2 screws in the needle plate using the L-screwdriver provided with your machine. Remove the needle plate.
4. Remove the bobbin from the bobbin case.
5. Take a hold of the bobbin case with your thumb and index finger at about 7 o'clock. Push it lightly to the right as you lift, the bobbin case will easily slip out of the hook race area.
6. Using the small brush that was provided with your machine remove lint and fluff from the hook race area, as well as the feed teeth area.
7. Your machine has been pre-lubricated at the factory; as a result oiling the bobbin case area is not necessary.
8. To reinsert the bobbin case, make sure the needle is at the highest position. (The take-up lever should be visible over the top of the machine).
9. Take a hold of the bobbin case with your thumb and index finger at 6 o'clock directly over the left screw at the center front of the bobbin case.
10. Guide the forked end of the bobbin case under the feed teeth and then move the bobbin case from right to left, until it is seated correctly in the hook race.
11. To ensure that the bobbin case is in the correct position, turn the handwheel towards you; the hook race should turn freely in a counter-clockwise direction.
12. Make sure the needle is again at the highest position. Reposition the needle plate over the feed dogs and secure in place using the 2 screws that you removed earlier.
13. Attach presser foot, insert bobbin and replace bobbin cover. You are now ready to sew.

### Sewing Light

This appliance is equipped with a durable LED illumination, which is expected to last for the lifetime of the equipment.

Please contact a local service agent, should the lamp nevertheless require to be replaced.

**Backstitch**

Backstitching is most commonly used at the beginning and ending of seams to lock the stitching so it does not come undone. Start sewing the beginning of the seam about 3-4 stitches, then sew in reverse for 3-4 stitches. Start sewing forward again and continue sewing the seam to the end, then sew in reverse 3-4 stitches, then forward again to finish.

**Basting**

Basting is temporary stitching, sewn using a long straight stitch and reduced tension. This temporary stitching holds fabrics together, but is intended to be removed. For example, basting the side seams of a skirt to check the fit, then the final seam is sewn and the basting stitch is removed.

**Free Arm**

In order to sew small, tubular projects such as a pant leg, sleeve cuff, etc, you will need to take the removable storage compartment off the machine, giving access to the free arm.

**Interfacing**

Interfacing is specially designed material, sewn between fabrics, used to provide additional structure to parts of a garment, for example, cuffs, collars, plackets, etc. It can be used for buttonholes to help keep the fabric stable while sewing.

**Raw Edge**

The raw edge of the fabric refers to the cut edge and usually becomes the edge of the seam allowance.

**Seam**

A seam is stitching that joins two fabrics together, includes the main stitching line and the seam allowance.

**Seam Allowance**

The seam allowance is the amount of fabric between the seam stitches and the raw edge of the fabric. The most popular seam allowance are 5/8" and 1/2".

**Seam Finish**

Seam finishing is stitching used to keep a raw edge from unraveling or fraying.

**Stabilizer**

Stabilizer is special material used to provide additional support for stitches for special techniques such as decorative machine stitching, appliqué, buttonholes and more.

**Topstitching**

Topstitching is straight stitching that appears on the top side of the fabric, used for adding strength, embellishment or both.



Please note that on disposal, this product must be safely recycled in accordance with relevant National legislation relating to electrical/electronic products. Do not dispose of electrical appliances as unsorted municipal waste, use separate collection facilities. Contact your local government for information regarding the collection systems available. When replacing old appliances with new ones, the retailer may be legally obligated to take back your old appliance for disposal free of charge.

If electrical appliances are disposed of in landfills or dumps, hazardous substances can leak into the groundwater and get into the food chain, damaging your health and well-being.

