

# Easy Stick Roller Blind

## INSTRUCTIONS

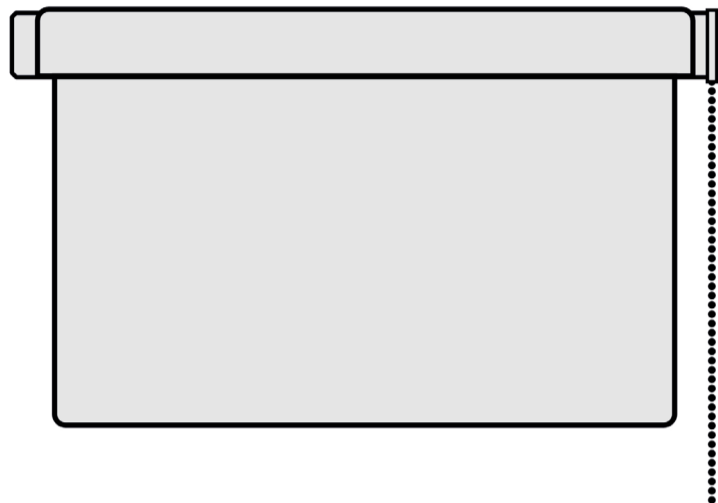

[www.dunelm.com](http://www.dunelm.com)

← UNFOLD FOR FULL INSTRUCTIONS →

### CHILD SAFETY WARNING

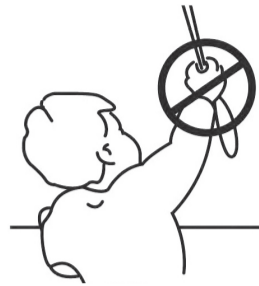

- Young children can be strangled by loops in pull cords, chains, tapes and inner cords that operate the product.
- To avoid strangulation and entanglement, keep cords out of the reach of young children.
- Cords may become wrapped around a child's neck. Move beds, cots and furniture away from window covering cords.
- Do not tie cords together.
- Make sure cords do not twist and create a loop.

**PERSONS IN CHARGE OF CHILDREN ARE ULTIMATELY RESPONSIBLE FOR FOLLOWING THE SAFETY INSTRUCTIONS PROVIDED BY THE MANUFACTURER AND TO USE ANY SAFETY DEVICE SUPPLIED.**

**The installation can be completed by non-professionals.**

#### Safety Recommendations

- Always use a Step Ladder when working at height.
- We recommend you use two people for the installation of larger blinds.
- DO NOT over reach. DO NOT hold or lean on the blind to support your weight. Always move the Step Ladder so that you are in a safe working position.
- Take care when using power tools, use of a Residual Current Device (RCD) is recommended. Always use eye protection when drilling. Beware of hidden pipe runs and cables.
- No liability will be accepted for damage or injury caused by incorrectly installed or assembled product.

PLEASE KEEP OUT OF THE REACH OF YOUNG CHILDREN. SMALL PARTS - CHOKING HAZARD.

Please keep these instructions and batch code from packaging for future reference.

[www.dunelm.com](http://www.dunelm.com)

### Important



#### Important Safety Instructions

Read these instructions carefully before installing this blind. Keep these instructions for future reference.

Blind head rails should not be installed less than 1.5m from the floor.

Small parts can present a choking hazard if accidentally swallowed. Keep small parts away from young children.



Once a blind has been cut, it cannot be returned - however this does not affect your statutory rights.

Ensure that all wall plugs and screws provided are suitable for your type of wall/window. If in doubt consult a professional.

If the blind has a symmetrical pattern, it is recommended that the fabric is cut on either side to achieve the required width and keep the pattern symmetrical.

This blind is maintenance-free.

### Kit content

Visual	Qty
Easy Stick Brackets 	2
Fixing Nails 	8

#### Important Note

This product is only suitable for fixing inside the recess and is not suitable for fixing on tiled walls or rough, uneven surfaces

### Tools required

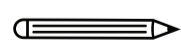
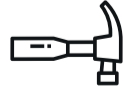
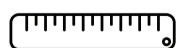
Visual	Qty
 Pencil	1
 Hammer	1
 Ruler	1

Take care when using the tools, wear gloves and eye protection.

# Installation Guide

Our blackout blinds are made with 100% blackout fabric, please note however due to the fixing method the blind will hang slightly away from the window, therefore the light can still come through the sides of the blind.

Further improved room darkening can be achieved by layering blinds and curtains together at the window. See our blackout range on dunelm.com.

## Fitting the Brackets

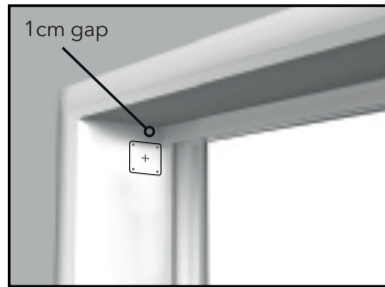

Remember to allow room for the control mechanism and your brackets, when fitting inside the window recess to aid smooth operation.

1. Position the brackets against the rear of the recess leaving at least 1cm gap between the top of the recess and the bracket and mark the location with a pencil.
2. With a dry cloth, clean the area where the bracket will be fitted to ensure it is free of dust and grime and moisture. Ensure the bracket is attached to a smooth flat surface.
3. Remove the backing from the adhesive pad and apply to the wall in the correct position and apply pressure for 30 seconds to ensure good adhesion.
4. With a small hammer knock in the four small nails in the holes in the corners of the bracket.
5. Repeat the process again on the other side ensuring the two brackets are level and fixed in the same position.

## Fitting the blind to the Brackets

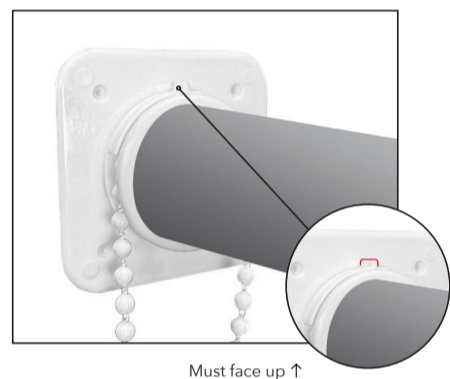

Now the brackets are in place, if the blind needs to be cut down, refer to the section below titled Cutting Down the Blind.

1. Push the control mechanism in to the left or right side of the blind
2. The chain guard must be positioned at the top to ensure correct operation
3. Place the pivot end in the other end
4. Push the pivot end into the bracket, then push the control mechanism into the other bracket

## Operating the blind

The blind will now operate by pulling on the beaded cord to raise and lower it.

## Care advice

Wipe clean only.

**Note** Modification of the design or configuration of the blind or its integral or non-integral component parts shall not be made without consulting the manufacturer. Use of the additional safety device helps reduce the risk of strangulation but cannot be considered completely fool proof.

## HOW TO CORRECT FABRIC RUN OFF

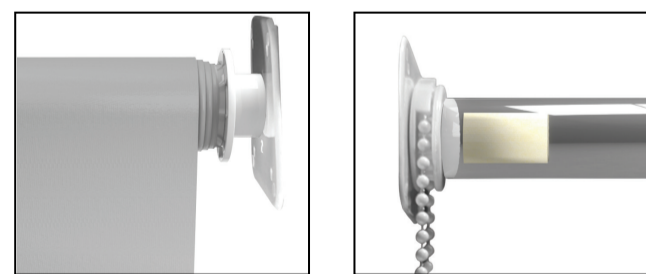

The illustration shows the fabric running off from the right hand side of the blind. To correct this, simply stick a small (30mm) strip of masking tape to the aluminium tube at the opposite end. Fully wind the blind up and then repeat until the fabric is no longer running off.

# Wall fixings

## Step by step

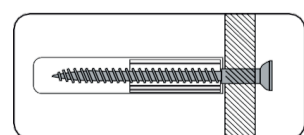

### Important

When drilling into walls always check there are no hidden wires or pipes etc. Make sure that the screws and wall plugs being used are suitable for supporting your blind. Consult a qualified tradesperson if you are unsure.

## Hints

1. General Rule; Always use a larger screw and wall plug if you are not sure.
2. Ensure you use the recommended drill bit to match the wall plug and hole size.
3. Ensure you drill the hole horizontally, do not force the drill or enlarge the hole.
4. Take extra care when drilling high walls, ceilings and ceramic tiles. Ensure the plug is fitting below the ceramic tile to avoid splitting or cracking.
5. Ensure wall plugs are well fitted and are a tight fit in the drilled hole.

## Removing the Easy Stick Bracket

To remove the easy stick bracket please follow the instructions below.

1. Using a pair of long nose pliers start by removing the four fixing nails.
2. Gently push a thin wallpaper scraper between the wall and plastic bracket and gently prise the moulding away from the wall.

## Cutting Down the Blind

Ensure hands and work surfaces are clean before unrolling the blind. Unroll the blind, taking care not to remove the blind from the inner tube. Place the blind face down on a flat surface.

Measure the distance between the brackets at the widest point. Now minus 2.2cm (22mm) off this measurement as this will allow for the mechanism. If you are not sure please cut less off and adjust again if necessary. Now mark the cut line using the pencil and ruler. Ensure that the line is straight from the top to the bottom.

Take the scissors and cut along the line to the top of the blind. Use the craft knife to cut the fabric attached to the tube. Ensure scissors and craft knife are sharp enough for a clean cut. On the inner tube make a cut mark with the pencil 0.5cm (5mm) longer than the fabric. Take the hacksaw and cut the tube.

Now take the bottom bar and make a cut mark to the same width as the cutdown blind. You can now insert the bottom bar and roll up the blind, make sure to keep it evenly rolled at both sides. To fit the blind refer back to the installation guide section of this leaflet.

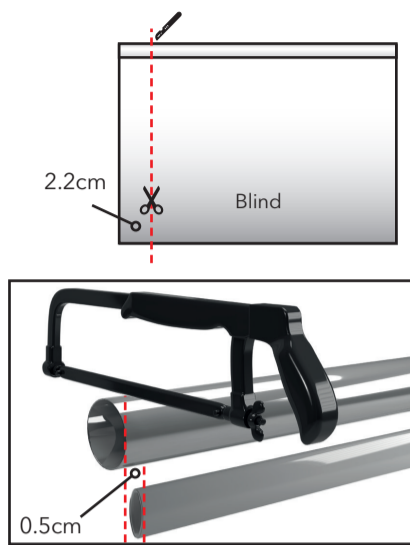

## Installing the Child Safety Device

Children can strangle if this device is not installed. Read the instructions carefully and install accordingly. Always use this device to keep cords or chains out of reach of children.

The device must be installed at the maximum distance possible from the control mechanism to prevent the chain loop being slack.

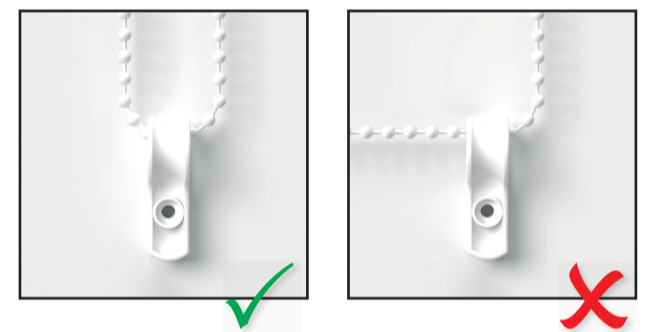

# Wall fixings

## Types of Walls

You can use one of the following types of wall plug if your walls are made of brick, breeze block, concrete, stone, wood or plastic board.

### 1. STANDARD Wall Plug

General wall materials

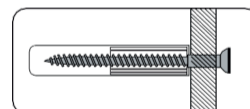

These come in various sizes and are made from plastic or sometimes wood fibre.

### 2. GENERAL PURPOSE Wall Plug

Aerated/Breeze block

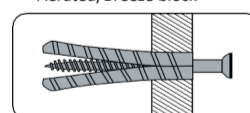

Generally aerated blocks should not be used to support heavy loads, use a specialist fitting in this case. For light loads, a General Purpose Plug can be used.

### 3. SHIELD ANCHOR Wall Plug

Heavy loads

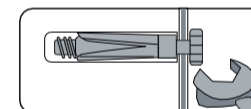

For use with heavier loads such as TV & Hi-fi Speakers and Satellite Dishes etc.

### 4. CAVITY FIXING Wall Plug

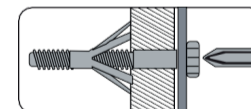

For use with plaster board partitions or hollow wooden doors.

### 5. CAVITY FIXING HEAVY DUTY Wall Plug

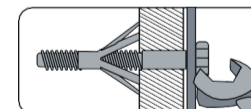

For use with plaster board partitions or hollow wooden doors.

### 6. HAMMER FIXING Wall Plug

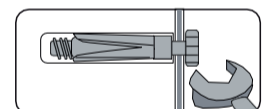

For use with walls stuck with plaster board. The hammer fixing allows it to be fixed to the wall rather than the plaster board. Always check the fixing is secure to the retaining wall.

## Care and Maintenance

**! Safety**  
Always check the fitting and location to ensure your safety in and around the home.

**! Fitting**  
From time to time check the fitting to ensure the wall plugs or screws do not become loose.

- Please ensure that you use fittings that are suitable for your wall type (see wall fixings information for a general guide).
- Please ensure that the head of the screws used has a diameter greater than the diameter of the hole on the wall fixing and that the fixing is safe and secure before using.
- When drilling into the walls, always ensure there are no hidden wires or pipes.
- If you are unsure, we recommend you consult a qualified Trades person.