

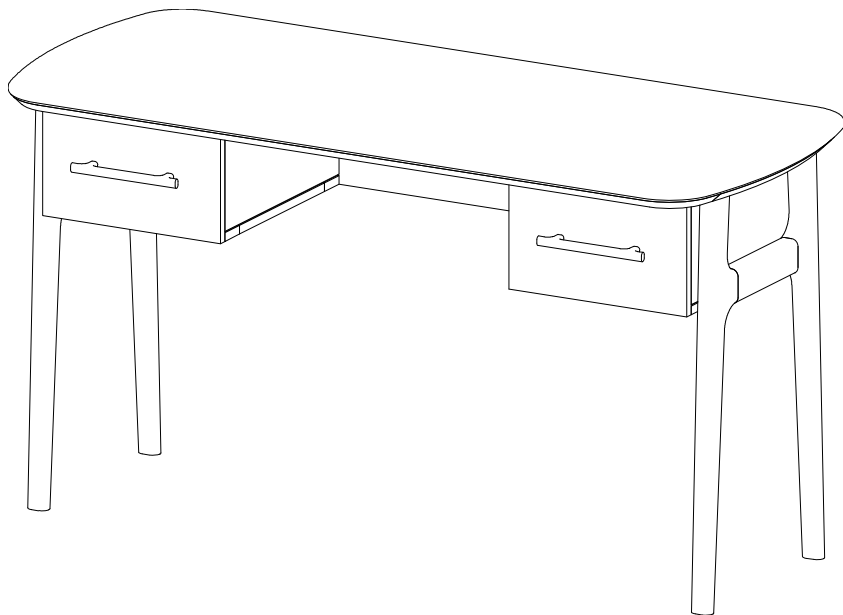



Maxton Desk

Assembly & Care Instructions







1. Check you have received all parts listed on the component and hardware pages and the correct quantity of each. Beware that sometimes parts are packaged within the product so not immediately visible after opening. Please check the assembly section for more details. If anything is missing, stop assembling the product and contact our customer service team.
2. Check all parts are intact and undamaged. Any issues, stop assembling the product and contact our customer service team.
3. Check you have the right tools for the job. Required tools which are not provided are listed below. If you are unsure of how to use these tools, please contact a professional tradesperson. We recommend Airtasker as an easy way to find trades people in your local area.

Tools required which are not included			
Flat head screwdriver	Tape measure	Pencil	Drill
			

Safety advice.

Dear Customer

- **IMPORTANT** – The first step you need to take is to ensure your safety! Please take the time to read and understand these instructions before assembling the product.
- Please keep these instructions for future reference.
- This item is intended for indoor use only – unless otherwise specified. Avoid exposure to humid conditions.
- Assembly to be carried out by a competent adult only.
- During assembly children should be kept away from the product due to possible risk of injury. The product may contain small parts that could also cause choking if swallowed.
- Products can be dangerous if incorrectly installed or assembled. Assembly should be carried out by a competent person and instructions followed. No liability will be accepted for damage or injury caused by incorrectly installed or assembled products.
- Never use an electric drill to assemble a product, as this can cause damage to parts.
- Regularly check all fastenings to ensure that they are properly tightened.
- Restrain children from climbing or playing on or around the product. Always consider where products are positioned to ensure children cannot get access to long cords or windows.
- Some products will be supplied with anti – tip kits which should always be used to secure the product to the wall and prevent tipping.
- Keep all plastic wrapping materials away from babies and children to avoid danger of suffocation.
- Ensure that all packaging is disposed of carefully and responsibly. Please recycle where possible.
- Once items are part or fully assembled, they are not returnable unless faulty.

Max weight limit	No. of people to assemble	Assembly difficulty	Time to assemble
			
75 KG	2 recommended	Easy	<30 minutes

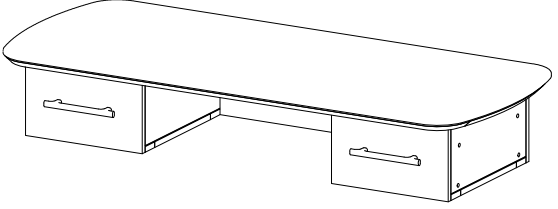
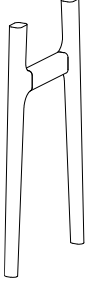
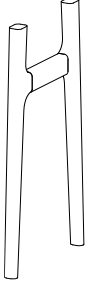
Ref	Part	Visual	Qty
1	Desk		1
2	Left Leg		1
3	Right Leg		1

Hardware supplied.

Ref	Hardware & dimension (mm)	Qty
A	Allen Bolt 6x30mm	8
B	Washer 8x16mm	8
C	Allen Key 5mm	1

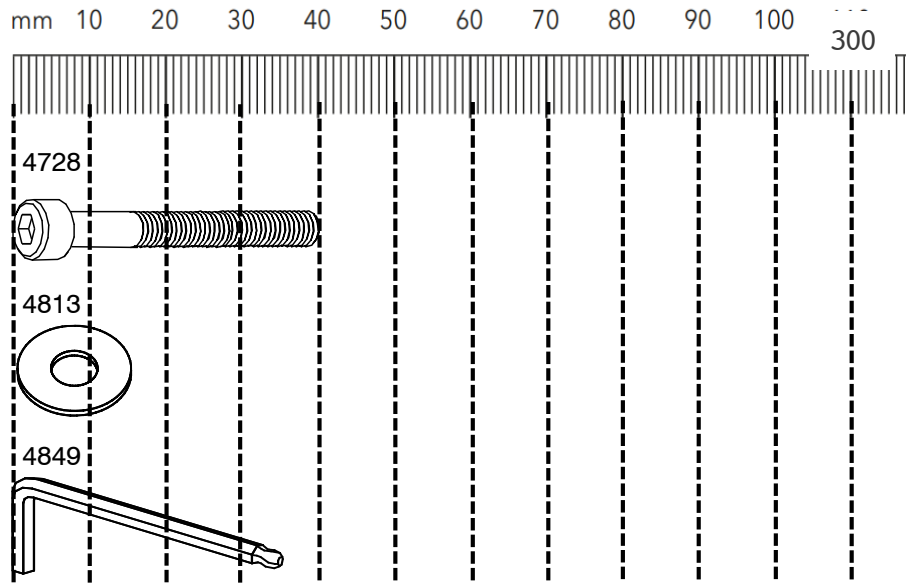

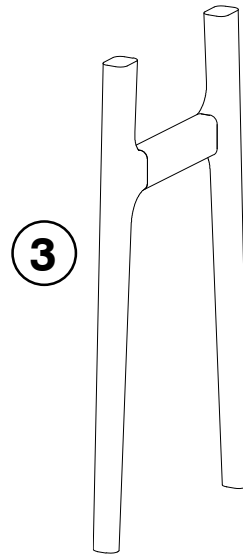
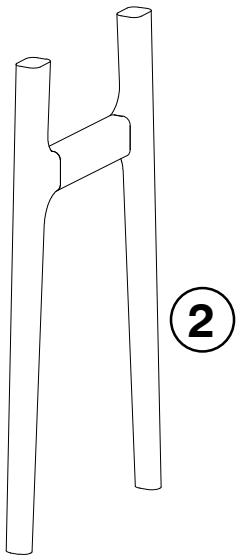
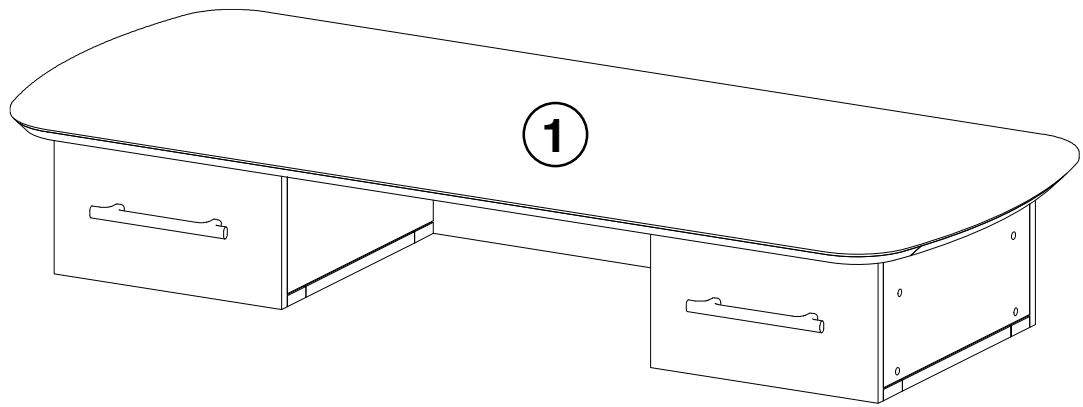

	<p>ALWAYS lay each panel down on a clean and level area, ideally in the room of intended use, ensuring there is enough room to maneuver around the item.</p>
	<p>NEVER pull furniture into place as this causes damage to the internal structure and feet fixings. Always lift to move.</p>
	<p>NEVER flip your upholstery allowing corners to hit the floor as structural damage can be caused. Always turn gently.</p>

1

1 x 1

	<p>ALWAYS lay each panel down on a clean and level area, ideally in the room of intended use, ensuring there is enough room to maneuver around the item.</p>
	<p>NEVER pull furniture into place as this causes damage to the internal structure and feet fixings. Always lift to move.</p>
	<p>NEVER flip your upholstery allowing corners to hit the floor as structural damage can be caused. Always turn gently.</p>

1

1 x 1	2 x 1	3 x 1	A x 4	B x 4	C x 1

	<p>ALWAYS lay each panel down on a clean and level area, ideally in the room of intended use, ensuring there is enough room to maneuver around the item.</p>
	<p>NEVER pull furniture into place as this causes damage to the internal structure and feet fixings. Always lift to move.</p>
	<p>NEVER flip your upholstery allowing corners to hit the floor as structural damage can be caused. Always turn gently.</p>

2

1 x 1	3 x 1	A x 4	B x 4	C x 1

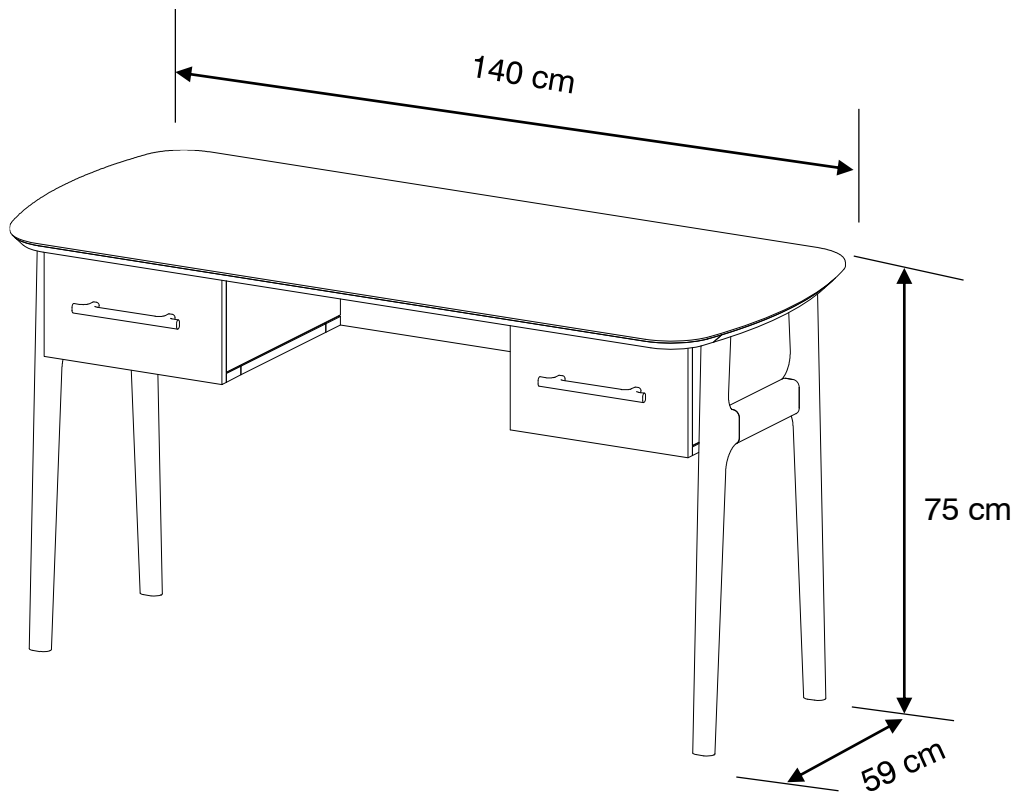

- Uneven floors could give the impression that doors are out of alignment or that the furniture is wobbly. Be aware of this and compensate, if necessary, by adjusting the hinges or packing a corner to level the item. Please refer to the assembly instructions and adjust accordingly.
- If your furniture becomes stained, scratched, chipped or suffers other damage, we recommend professional help is sought to restore it. Please contact our customer services line for recommended agents.
- **DO** move items such as ornaments or coasters around periodically to allow the colour to mellow evenly.
- **DO** use mats and coasters to protect the surface from heat, liquids, or items that may cause scratches.
- **DO** ensure plastic or felt feet protectors are securely fitted into place on the feet and legs to avoid scratches.
- **DO** check fittings and fixings from time-to-time and tighten when necessary. Stop using the product if still unstable after all screws and bolts are tightened.
- **DO NOT** drag your furniture when moving it as this can damage joints. Always lift furniture into place.

Timber Care

- Timber is a natural material and each piece is individual.
- Colour may mellow over time and new items can vary in shade from items that you have purchased previously.
- **DO** only clean using a damp cloth and mild detergent. Aim to dust weekly with a soft, lint-free cloth or duster to prevent any build up of dirt.
- **DO** ensure the polish you are using is correct for your product and finish.
- **DO** avoid getting furniture wet when mopping floors. Always move out of the way when possible.
- **DO** patch test polishes or cleaning products on a small discreet area before applying across the whole unit.
- **DO** remove any spills immediately to avoid staining.
- **DO NOT** place directly in front of heat sources such as radiators or fires as timber can be affected by temperature and humidity which may cause cracking and warping.
- **DO NOT** place timber product in direct sunlight, as this will cause the colour to change quickly.
- **DO NOT** use bleach or abrasive cleaners.
- **DO NOT** use abrasive polish or silicon-based polishes as these can affect the finish over time.

Customer service.



If you have any issues with this product, you can call our Customer Service team on:
0345 165 6565 Monday to Friday **9am to 5:00pm.**

Alternatively, you can contact our team by Live Chat on: **Dunelm.com**
Monday to Friday 8am - 8:30pm
Saturdays 8am - 5:30pm
Sundays and bank holidays 9am - 4:30pm.



Dunelm (Soft Furnishings) Ltd. LE7 1AD
& Dunelm (Soft Furnishings) Holdings
Ltd. Dublin D12 WR25.