

# **Kaspar Tub Chair**

INSTRUCTIONS

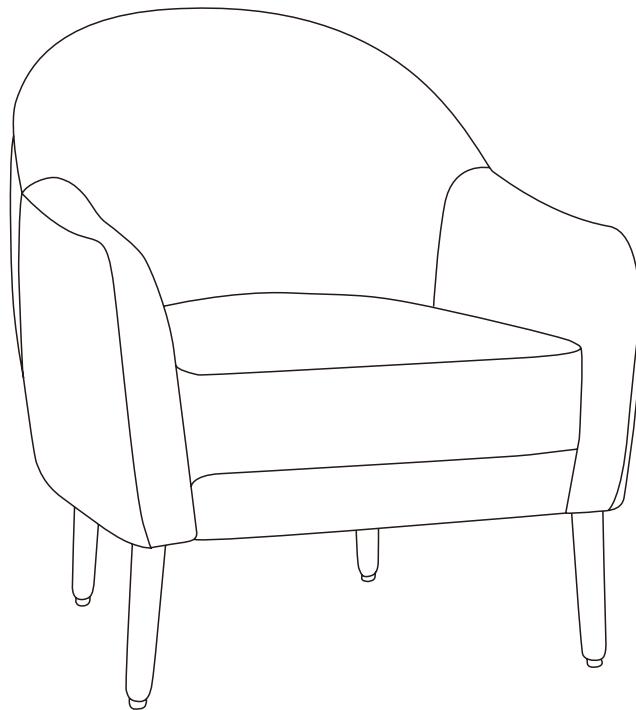

**Dunelm**  
[www.dunelm.com](http://www.dunelm.com)

Manufactured in China for Dunelm (Soft Furnishings) Ltd. LE7  
1AD & Dunelm (Soft Furnishings) Londonderry Ltd. BT48 8QN

# Thank You

## Dear Customer

Thank you for purchasing your new piece of furniture from Dunelm. We put a lot of effort in the design and construction of our products to ensure they set the standard for quality, durability and ease of assembly.

If for any reason you feel we haven't lived up to the high standards we set ourselves, please don't hesitate in contacting us on **03451 656565** where our team will be very keen to understand what has gone wrong and, more importantly, put it right.

## The next step...

There is no need to feel daunted by the number of parts and fittings in front of you, we have compiled this straight forward, step-by-step guide to make sure that assembling your furniture is as easy as 1, 2, 3.

Before you begin, we advise that you check that you have everything you need to get started.

## Top tip

Find a space to spread everything out across the floor before you begin assembling the item. Lay each panel down on a clean and level area, ideally in the room of intended use, ensuring there is enough room to manoeuvre around the item. It is recommended that two people assemble this product together. The full list of furniture parts, fixtures and fittings, as well as the tools you will need for assembly can be found on in this manual.

## Top tip

Identify all the fittings, make sure that you have them all prepared and familiarise yourself with each component to make things easier when you are putting it all together.

## Safety and care advice

**IMPORTANT** - The first step you need to take is to ensure your safety! Please take the time to read and understand these instructions before assembling your furniture.

Please keep these instructions for future reference.

Keep children and animals away from the assembly area. This furniture contains small parts that could cause choking if swallowed.

Keep all plastic wrapping materials away from babies and children to avoid danger of suffocation.

Ensure that all packaging is disposed of carefully and responsibly.

From time to time check that there are no loose fittings on the unit, re-tighten when necessary.

Two people may be required for the assembly of this product.

Once items are part or fully assembled, they are not returnable unless faulty.

This item is not for outdoor use – unless stated otherwise.

Some items will be supplied with a wall fixing strap which we recommend is used to secure the item to the wall to prevent a child from accidentally pulling furniture over. Furniture can be dangerous if incorrectly installed. Assembly should be carried out by a competent person. No liability will be accepted for damage or injury caused by incorrectly installed or assembled furniture.

**DO NOT** place this product near a window as it can be used as a step by the child and cause the child to fall out of the window

Be aware of the risk of open fires and other sources of strong heat in the vicinity of the product

**DO NOT** place this product near a window where cords from blinds or curtains could strangle a child.

**DO NOT** use the seating if any part is broken, torn or missing and use only spare parts approved by the manufacturer.

---

# Component Parts Supplied

---

Ref	Dimensions	Visual	Qty
A	N/A		1



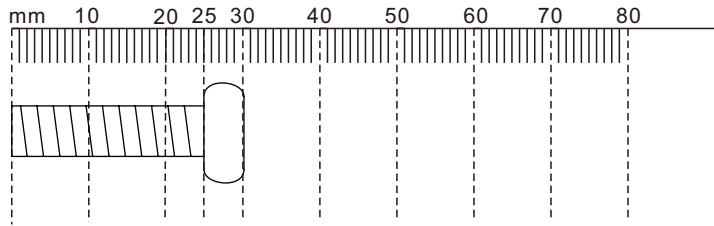

# Parts and fittings

## Fixtures and fittings supplied(actual size)

Ref	Dimensions	Qty
B	M6x25MM	12



## Fixtures and fittings supplied(not to scale)

Ref	Dimensions	Visual	Qty
C	N/A		4
D	M6		12
E	M6*14*1.2MM		12
F	M6		1

**Step 1:**

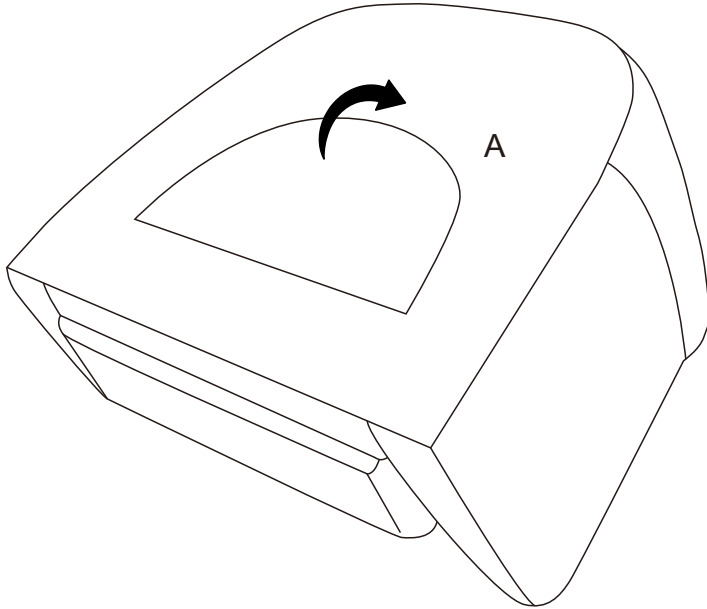

x4

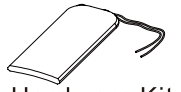

Hardware Kit

**Step 2:**

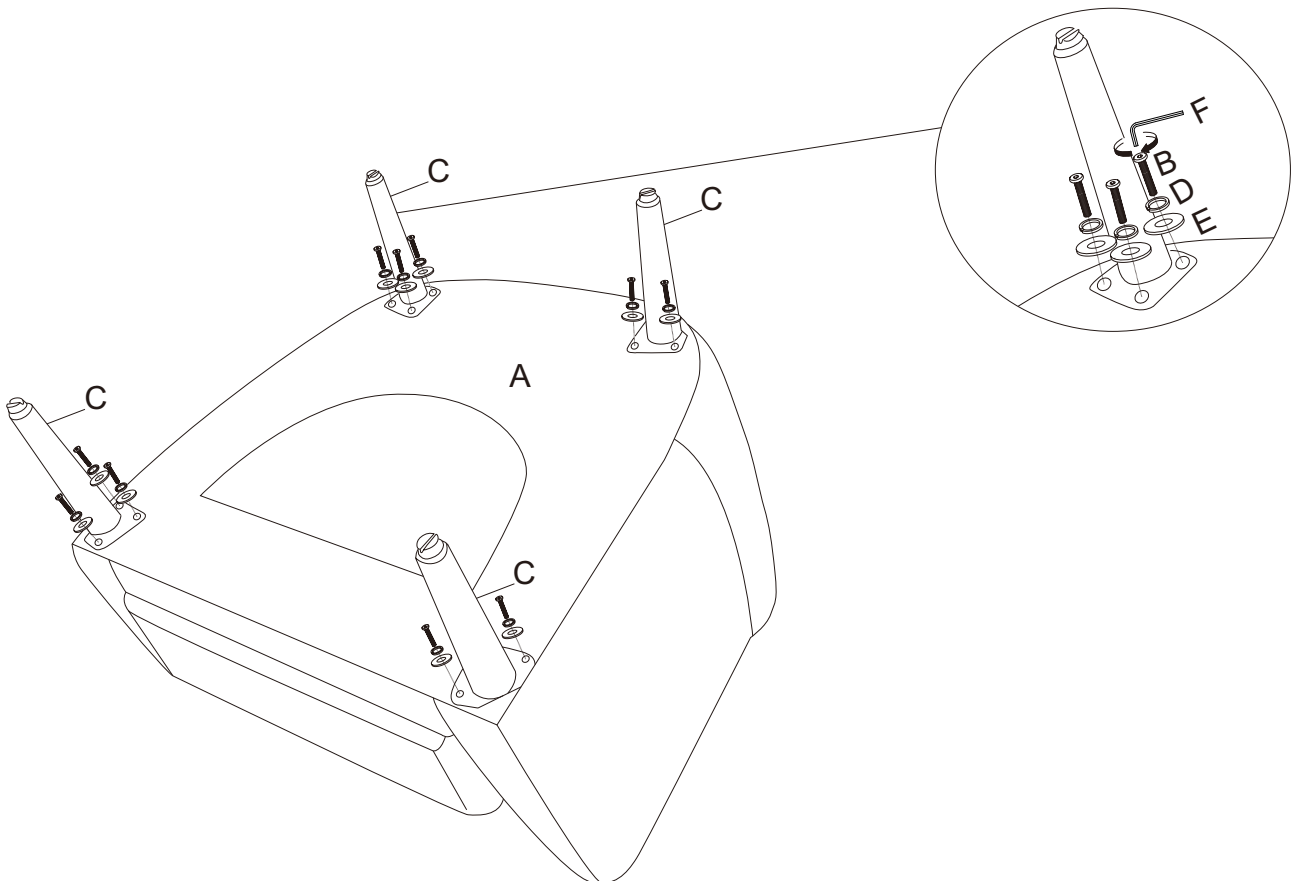

## Assembled chair:

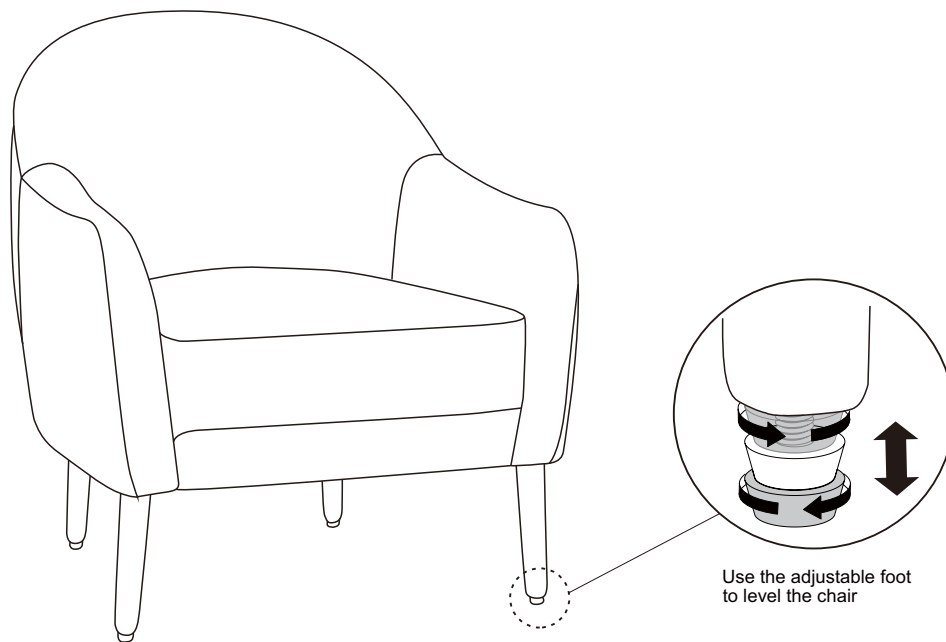

---

# Upholstery Care Advice

---

## Regular care advice

Vacuum clean your upholstery at least once a week, dust removal may be improved by pre-brushing with a soft cloth.

All reversible cushions should be turned daily, and their positions switched, this will help prevent excessive soiling and ensure wear-out is even.

## Cushion care

It is essential that all fibre cushions are given a vigorous plumping by shaking and squeezing to redistribute the fibre on a daily basis. This will add air back into the fibres to prevent the fibre from going flat and lumpy.

## General care advice

For items with wooden legs/ feet never place on a damp floor.

Keep upholstery out of direct sunlight to avoid discolouring.

Do not place the furniture in a conservatory, excessively dry or humid conditions.

Avoid sharp items such as toys, jean rivets and buckles coming into contact with the upholstery as these can easily snag, tear or pull the fabric.

To maintain the appearance and durability of your suite, restrain children and pets from climbing and jumping on the sofa.

Leather is a natural product and can display natural marks and characteristics such as healed scars, grain directions and creases. These are natural features and not faults.

Please dust leather regularly and clean with a damp cloth.

## For accidental spills or stains

Don't rub or scrub with a cloth as this could damage the fabric and remove the colour.

Don't use washing up liquid, detergents or bleach to remove stains.

Don't soak or allow fabric to become wet.

Do blot or soak up spills immediately using a dry soft colourfast cloth.

Do use specialist upholstery cleaner if needed, always follow the manufacturer's instructions and always test on a hidden area to check colour fastness. Allow the test patch to completely dry first. If the fabric colour is affected, do not use this cleaner on the rest of your product and consult a specialist.

---

# Wood Care Advice

---

## Wood care advice

Wood is a natural product and each piece is individual.

As a natural product, wood is affected by temperature and humidity. We recommend that you avoid placing the furniture directly in front of heat sources such as radiators or fires as this can cause cracking or warping over time.

The colour will mellow over time and new items can vary in shade from items that you have already purchased.

Strong direct sunlight can affect the colour dramatically, so try to avoid this as much as possible, we also recommend that any ornaments, coasters and items placed on the product are periodically moved around to allow the colour to mellow evenly.

Always use mats and coasters to protect the surface when placing items on the furniture. This will help to protect the finish from heat, liquids or items that might scratch your furniture.

If items are to be placed on the surface of your furniture and have rubber feet, it is advisable to use mats to prevent marking.

Always lift your furniture into place, avoid dragging it across the floor as this can cause damage to joints.

When placing furniture on a wooden or laminate floor, please ensure that the plastic or felt protectors are securely fitted and in place.

Only clean using a damp cloth and mild detergent, do not use bleach or abrasive cleaners.

From time to time check that there are no loose screws on this unit.

Remove any spills immediately to avoid staining.

Dust regularly with a soft lint free cloth or duster.

The use of abrasive polish or silicon-based polishes is not advised as these can affect the polished finish and joints over time.

Uneven floors could give the impression that doors of wall units and wardrobes are out of alignment. Be aware of this and compensate if necessary by adjusting the hinges or packing a corner to level the item. Please refer to the instructions, included with your furniture, and adjust accordingly.

If your furniture becomes stained, scratched, chipped or suffers other damage, we recommend professional help is sought to restore it. Please contact our customer services line for recommended agents.

Always follow fitting instructions carefully and retain them for future use.

**Finally, we hope you enjoy your furniture for many years to come and thanks again for your purchase.**