

Upholstery care advice

Regular care advice

Vacuum clean your upholstery at least once a week, dust removal may be improved by pre-brushing with a soft cloth.

General care advice

For items with wooden legs/feet never place on a damp floor.

Keep upholstery out of direct sunlight to avoid discolouring.

Do not place the furniture in a conservatory,excessively dry or humid conditions.

Avoid sharp items such as toys,jean rivets and buckles coming into contact with the upholstery as these can easily snag,tear or pull the fabric.

To maintain the appearance and durability of your suite,restrain children and pets from climbing and jumping on the sofa.

Velvet has a directional pile resulting in colour change when the pile is brushed the wrong way or when the light catches it.Velvet can easily mark and may appear crushed when new,to resolve this sweep with a clothes brush to refresh the pile .Over time the pile may crush due to wear,but this is a characteristic of the velvet.For extreme cases the pile can be restored by steaming but consult a professional first.

For accidental spills stains

Don't rub or scrub with a cloth as this could damage the fabric and remove the colour.

Don't use washing up liquid,detergents or bleach to remove stains.

Don't soak or allow fabric to become wet.

Do blot or soak up spills immediately using a dry soft colourfast cloth.

Do use specialist upholstery cleaner if needed,always follow the manufacturer's instructions and always test on a hidden area to check colour fastness.

Manufactured in China for Dunelm (Soft Furnishings) Ltd. LE7 1AD
&Dunelm (Soft Furnishings) Londonderry Ltd. BT48 8QN

www.dunelm.com

Bella Chair

INSTRUCTIONS

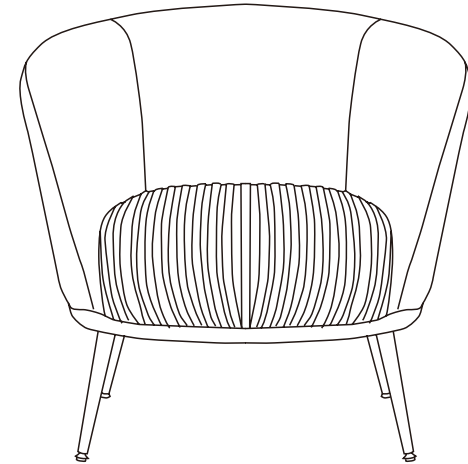

Dunelm
www.dunelm.com

Dear Customer

Check the pack and make sure you have all the parts listed below . If not, contact the helpline on **03451 656565** who will be able to help you

Safety advice

IMPORTANT -The first step you need to take is to ensure your safety !Please take the time to read and understand these instructions before assembling your furniture .

Please keep these instructions for future reference

Keep children and animals away from the assembly area . This furniture contains small parts that could cause choking if swallowed

Keep all plastic wrapping materials away from babies and children to avoid danger of suffocation

Ensure that all packaging is disposed of carefully and responsibly

From time to time check that there are no loose fittings on the unit, re - tighten when necessary .

Two people may be required for the assembly of this product.

Once items are part or fully assembled , they are not returnable unless faulty .





This item is not for outdoor use - unless stated otherwise

Some items will be supplied with a wall fixing strap , which we recommend is used to secure the item to the wall, to prevent a child from accidentally pulling furniture over . Furniture can be

dangerous if incorrectly installed. Assembly should be carried out by a competent person . No

liability will be accepted for damage or injury caused by incorrectly installed or assembled furniture.

Parts and fittings

Ref	Dimensions	Visual	Qty	Ref	Dimensions	Visual	Qty
1	N/A		1	A	M6x25MM		12
2	N/A		4	B	N/A		1

Step 1:

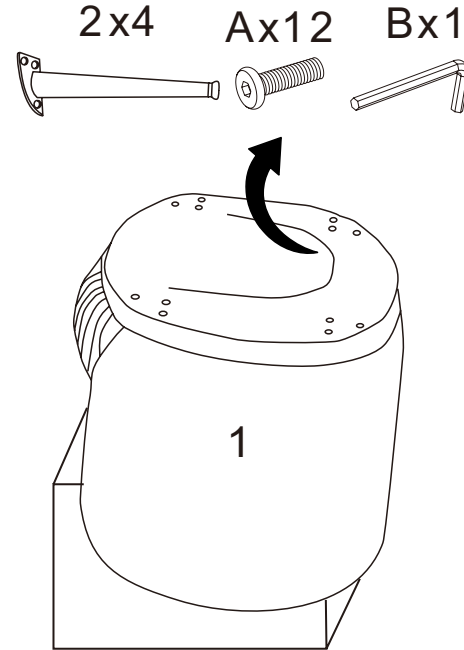

Step 2:

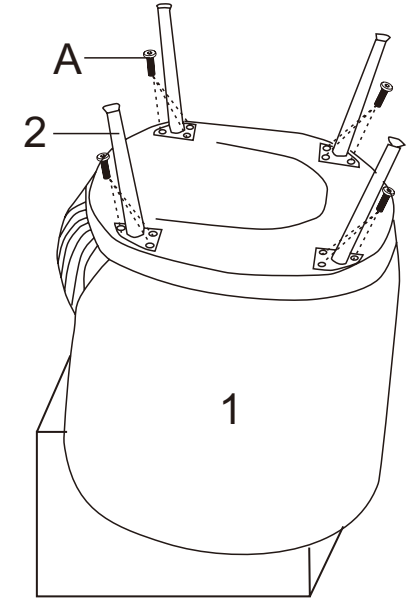

Step 3:

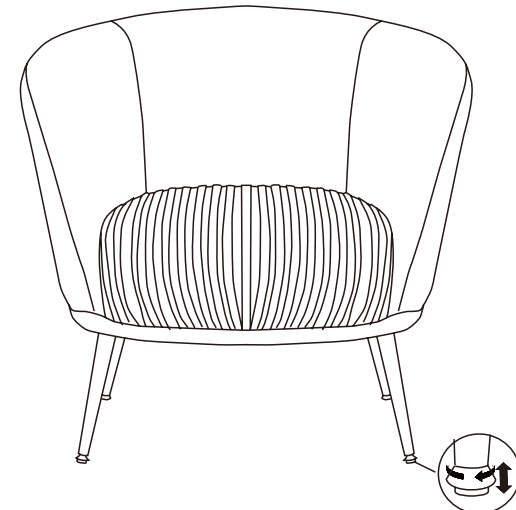

Use the adjustable foot to level the chair