

# D4/D14 ASSEMBLY INSTRUCTION

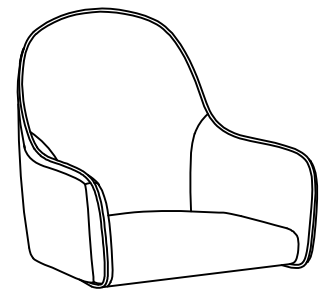

① × 1

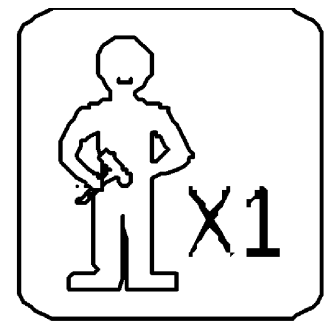
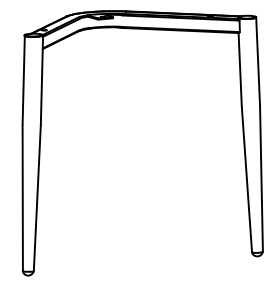

② × 1



③ × 1

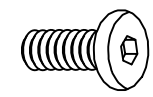

M6 × 20MM

④ × 2

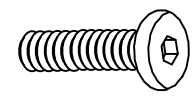
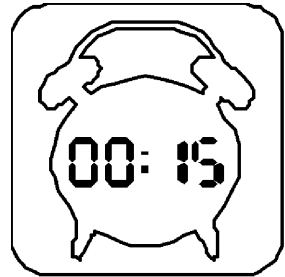

M6 × 45MM

⑤ × 4

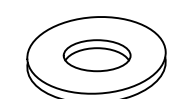

φ 16 / φ 6mm

⑥ × 6

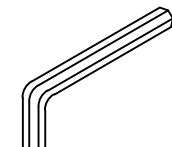

4mm

⑦ × 1

## STEP 1

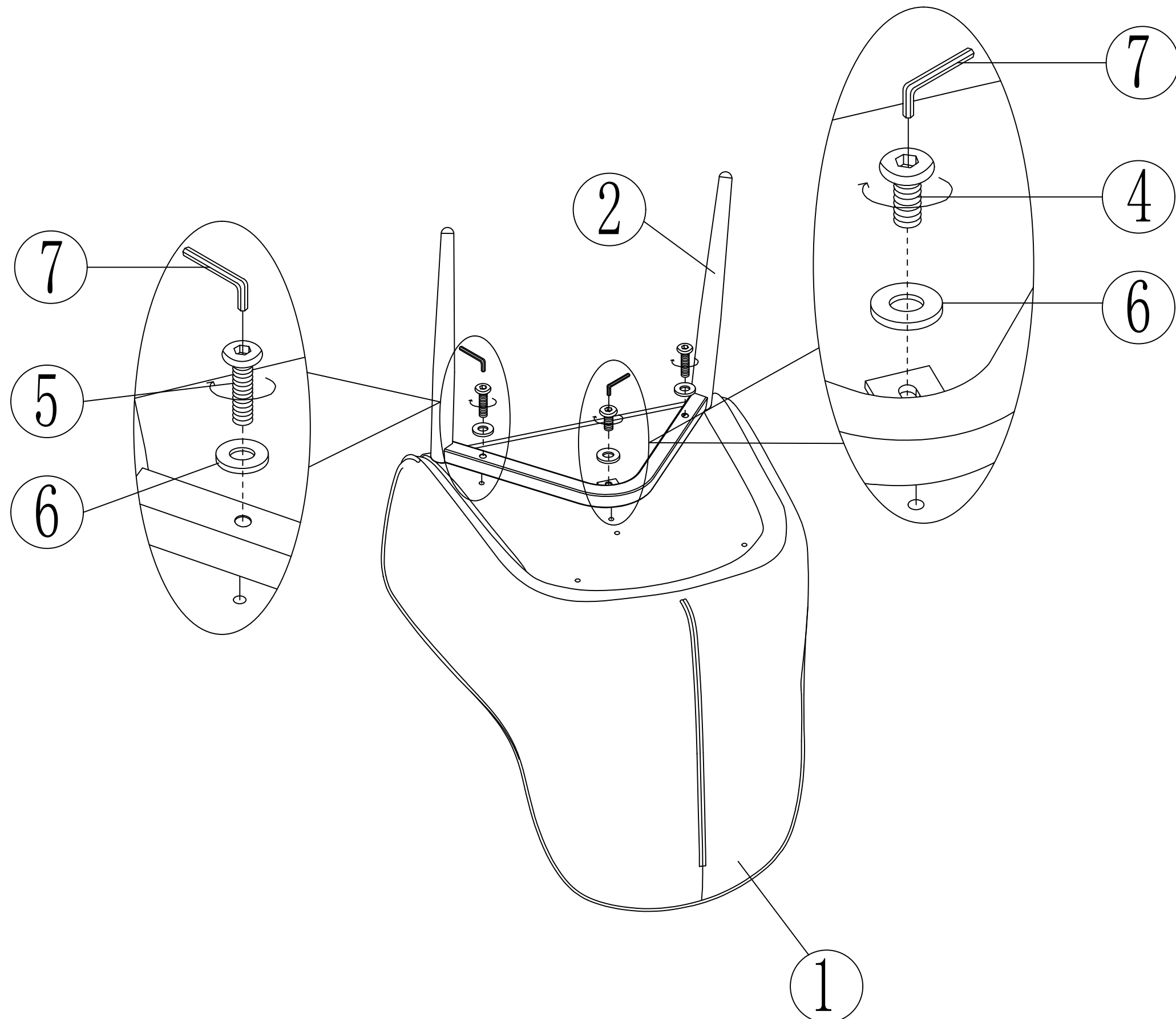

## STEP 2

