

CH-K10 ASSEMBLY INSTRUCTION

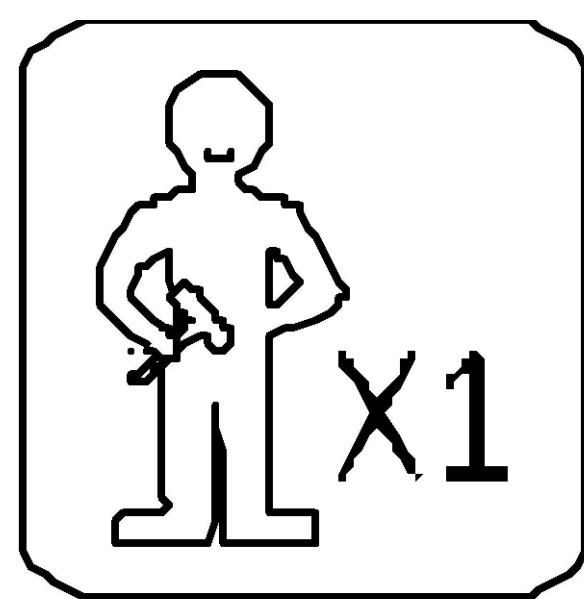

X1

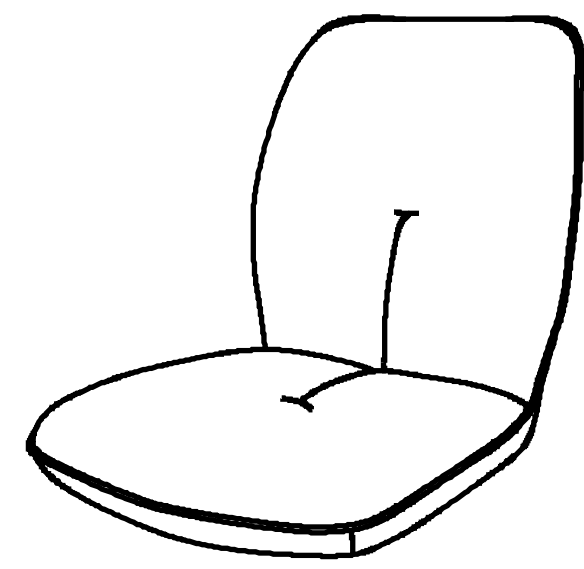

① X1

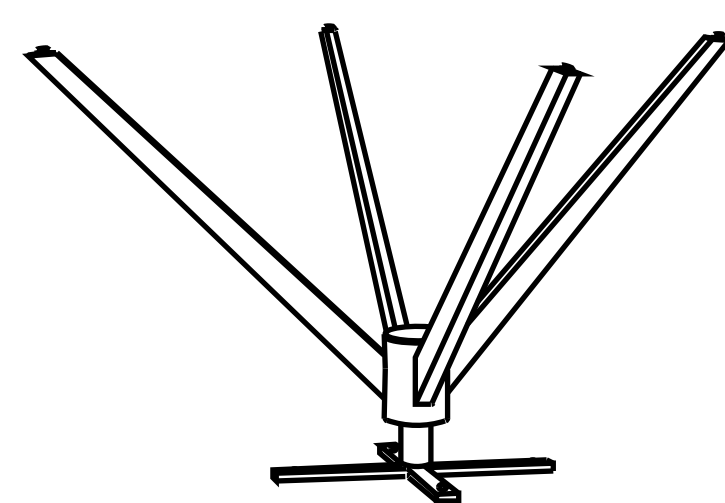

② X1

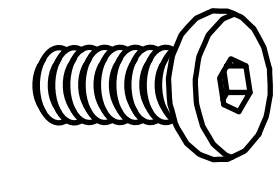

M6 X 20MM

③ X2

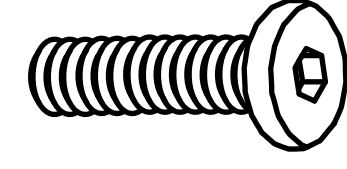

M6 X 25MM

④ X2

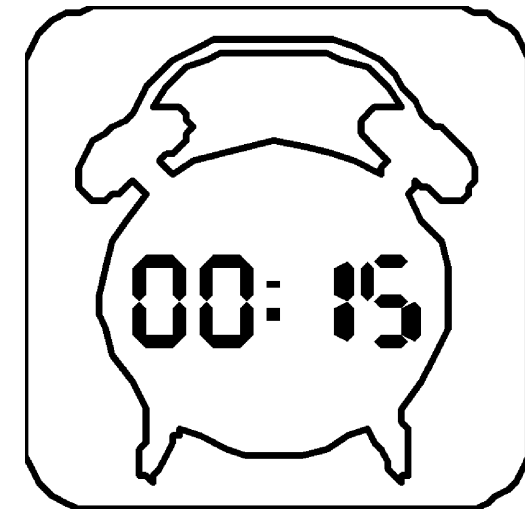

00:15

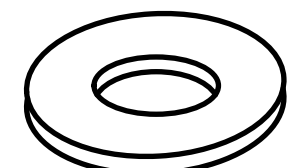

φ 16 / φ 6mm

⑤ X4

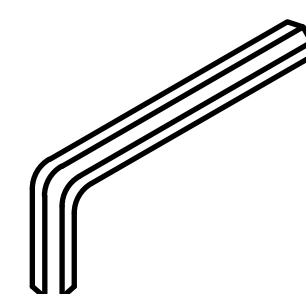

4mm

⑥ X1

STEP 1

