

Nixon Large Sideboard

INSTRUCTIONS

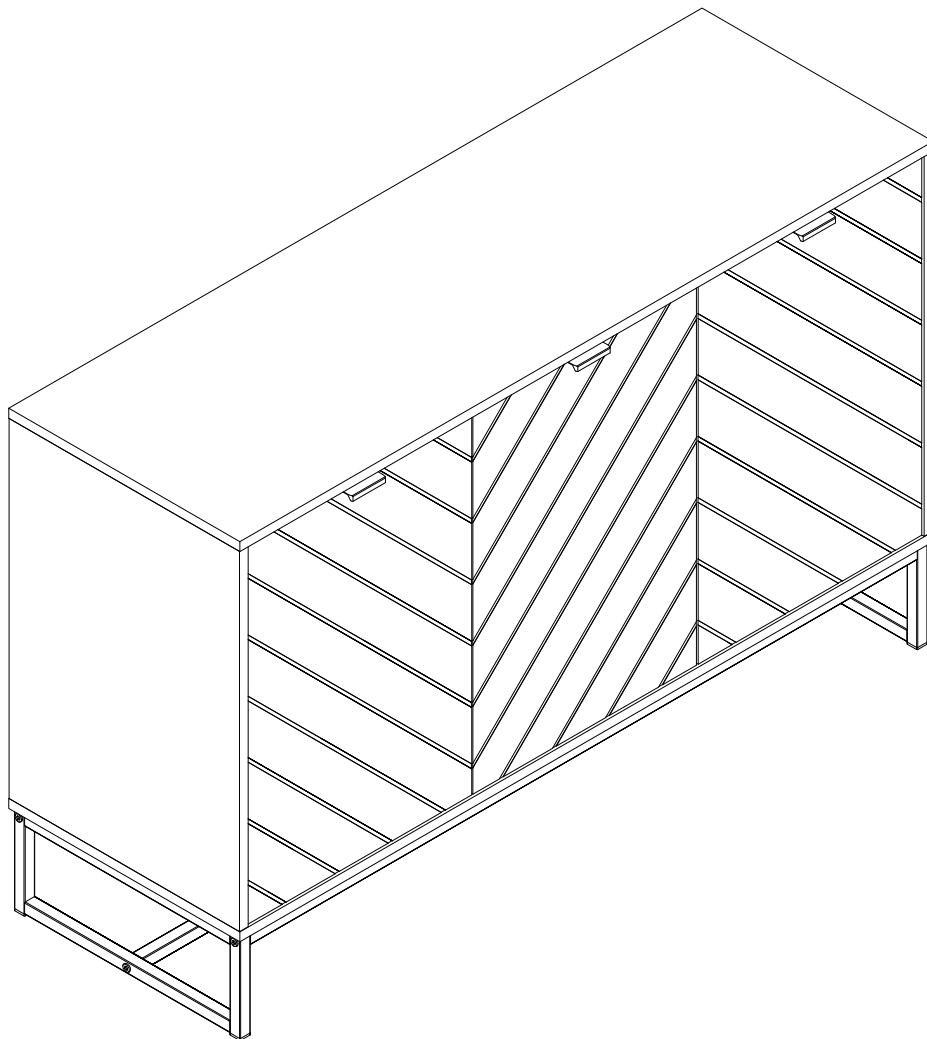

Dunelm

www.dunelm.com

Thank You

Dear Customer

Thank you for purchasing your new piece of furniture from Dunelm. We put a lot of effort in the design and construction of our products to ensure they set the standard for quality, durability and ease of assembly.

If for any reason you feel we haven't lived up to the high standards we set ourselves, please don't hesitate in contacting us on **03451 656565** where our team will be very keen to understand what has gone wrong and, more importantly, put it right.

The next step...

There is no need to feel daunted by the number of parts and fittings in front of you, we have compiled this straight forward, step-by-step guide to make sure that assembling your furniture is as easy as 1, 2, 3.

Before you begin, we advise that you check that you have everything you need to get started.

Top tip

Find a space to spread everything out across the floor before you begin assembling the item. Lay each panel down on a clean and level area, ideally in the room of intended use, ensuring there is enough room to manoeuvre around the item. It is recommended that two people assemble this product together. The full list of furniture parts, fixtures and fittings, as well as the tools you will need for assembly can be found on in this manual.

Top tip

Identify all the fittings, make sure that you have them all prepared and familiarise yourself with each component to make things easier when you are putting it all together.

Safety and care advice

IMPORTANT - The first step you need to take is to ensure your safety! Please take the time to read and understand these instructions before assembling your furniture.

Please keep these instructions for future reference.

Keep children and animals away from the assembly area. This furniture contains small parts that could cause choking if swallowed.

Keep all plastic wrapping materials away from babies and children to avoid danger of suffocation.

Ensure that all packaging is disposed of carefully and responsibly.

From time to time check that there are no loose fittings on the unit, re-tighten when necessary.

Two people may be required for the assembly of this product.

Once items are part or fully assembled they are not returnable unless faulty.







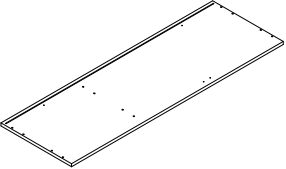
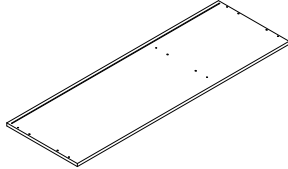
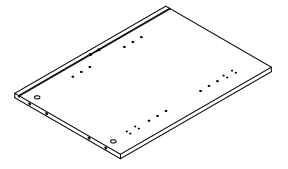
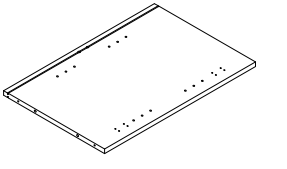
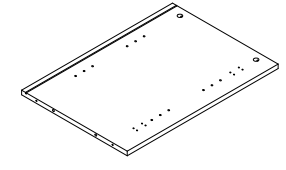
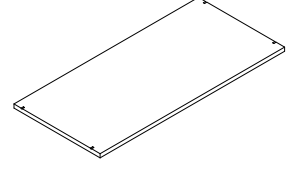
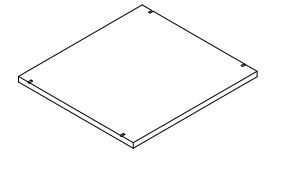
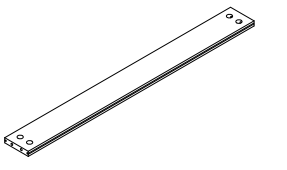
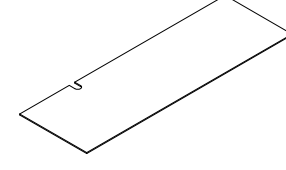
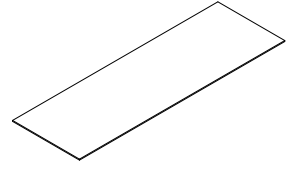
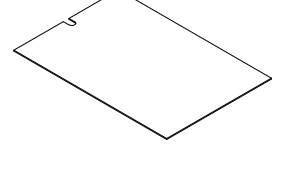
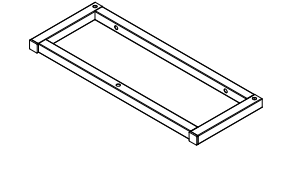
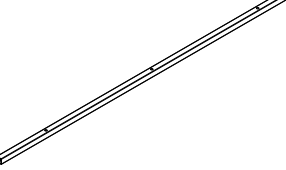
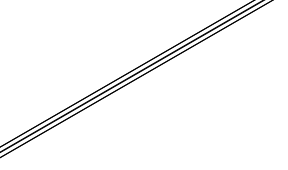
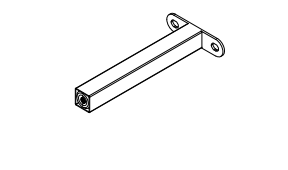
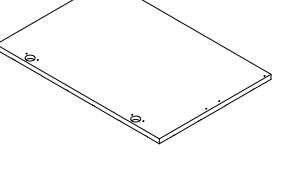
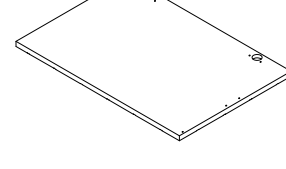
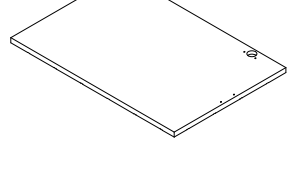



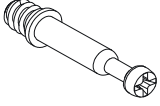

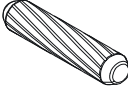
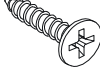
This item is not for outdoor use – unless stated otherwise.

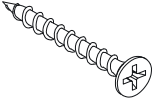
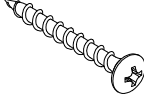
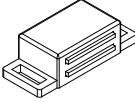
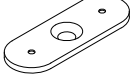
Some items will be supplied with a wall fixing strap which we recommend is used to secure the item to the wall to prevent a child from accidentally pulling furniture over. Furniture can be dangerous if incorrectly installed. Assembly should be carried out by a competent person. No liability will be accepted for damage or injury caused by incorrectly installed or assembled furniture.

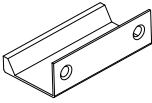
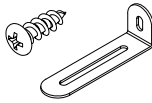
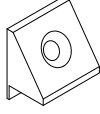
Component Parts Supplied

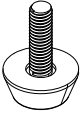
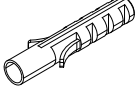
1 X 1 	2 X 1 	3 X 1 	4 X 1 
5 X 1 	6 X 2 	7 X 2 	8 X 1 
9 X 1 	10 X 1 	11 X 1 	12 X 2 
13 X 2 	14 X 1 	15 X 2 	16 X 1 
17 X 1 	18 X 1 		

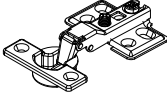
Parts and fittings

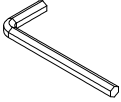
<p>A X 10</p>  <p>M6x35mm</p>	<p>B X 10</p>  <p>M15x10mm</p>	<p>C X 12</p>  <p>M6x30mm</p>	<p>D X 10</p>  <p>M3.5x14mm</p>	<p>E X 40</p>  <p>M6x30mm</p>
<p>F X 6</p>  <p>M4x14mm</p>	<p>G X 8</p>  <p>M4x35mm</p>	<p>H X 6</p>  <p>M4x30mm</p>	<p>I X 1</p> 	<p>J X 2</p> 
<p>K X 16</p> 	<p>L X 3</p> 	<p>M X 2</p> 	<p>N X 12</p> 	<p>O X 12</p>  <p>M3x14mm</p>
<p>P X 2</p> 	<p>Q X 2</p> 	<p>R X 4</p> 	<p>S X 2</p> 	<p>T X 4</p>  <p>M6x12mm</p>
<p>U X 1</p> 				

Exploded view

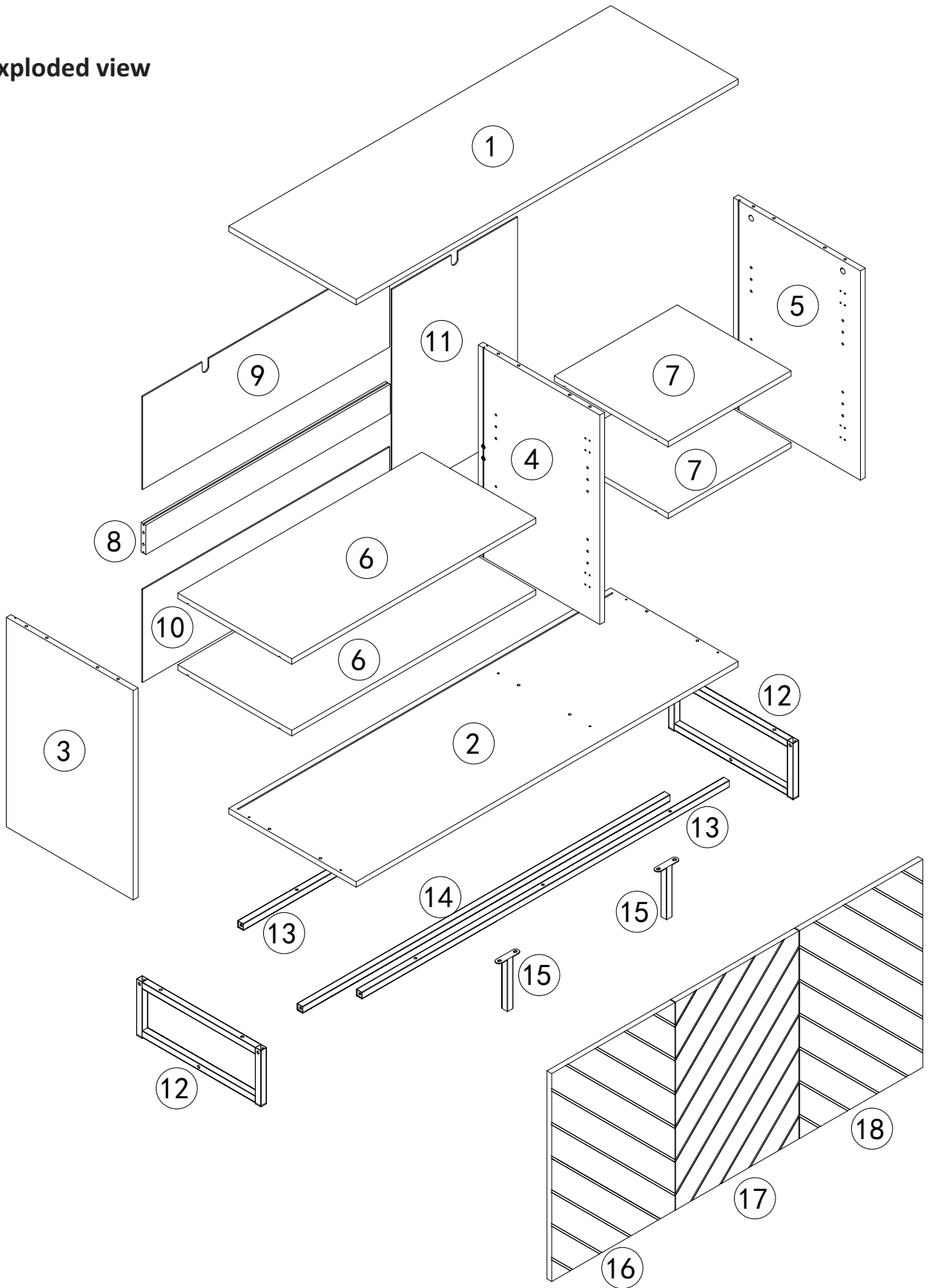

Step 1:

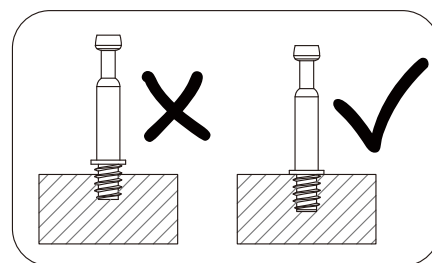
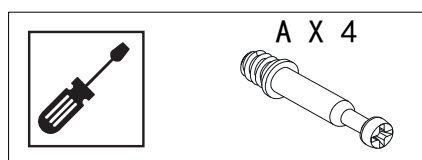
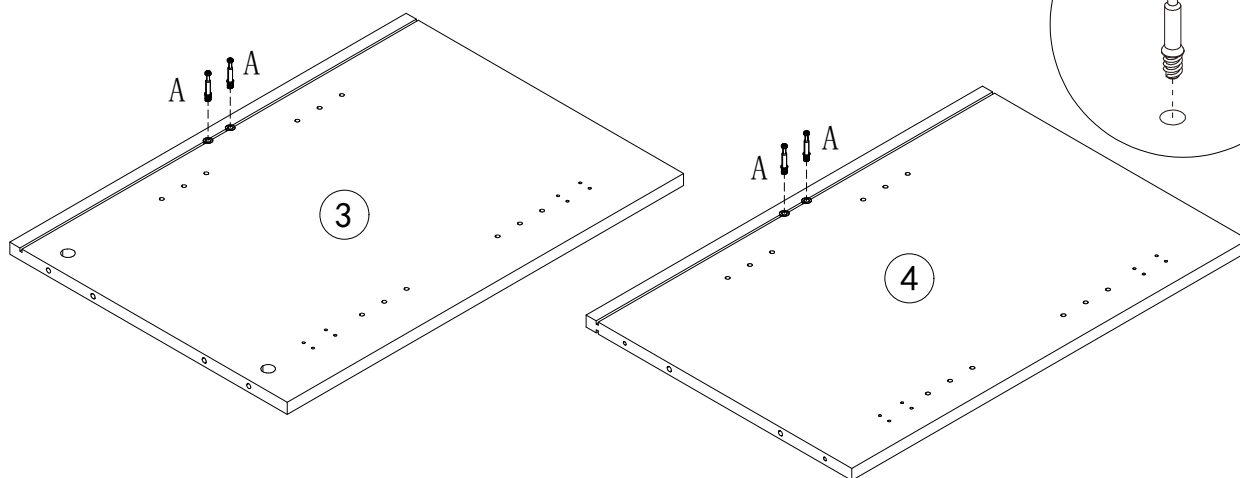

Step 2:

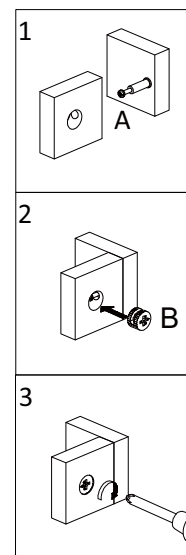
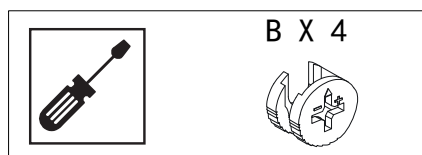
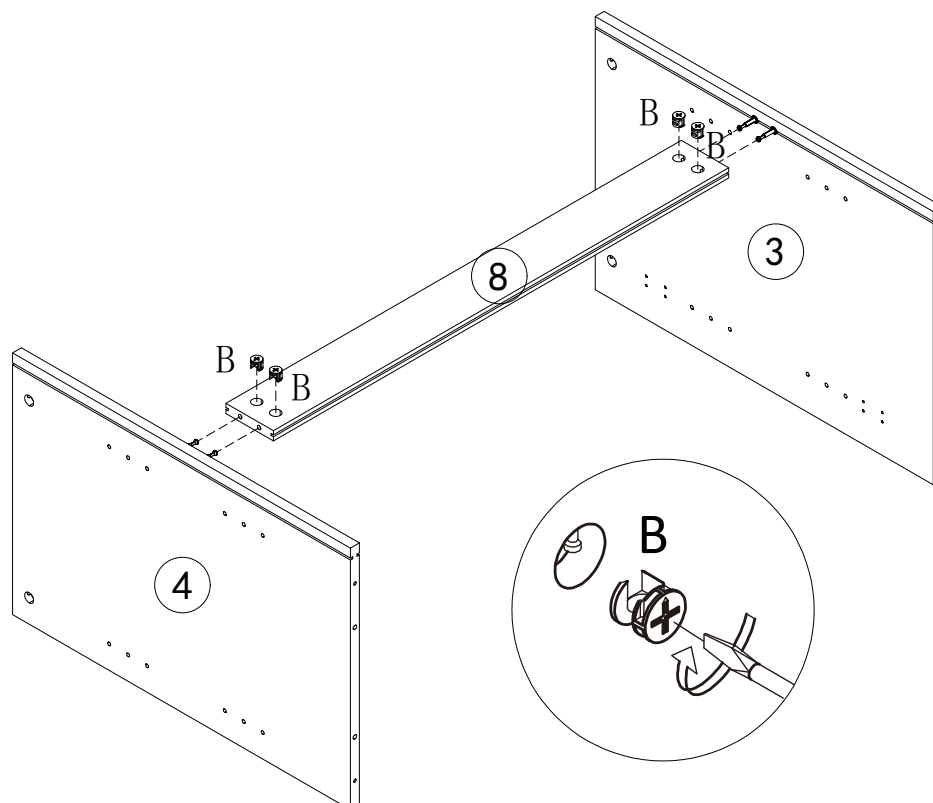

Step 3:

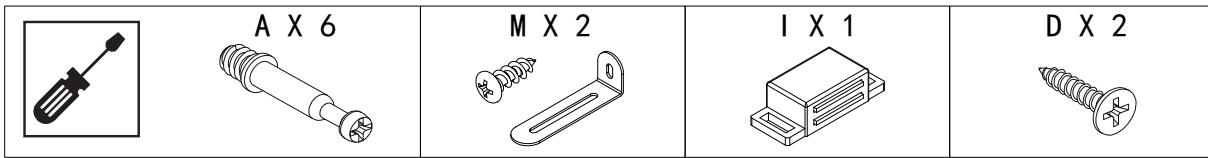
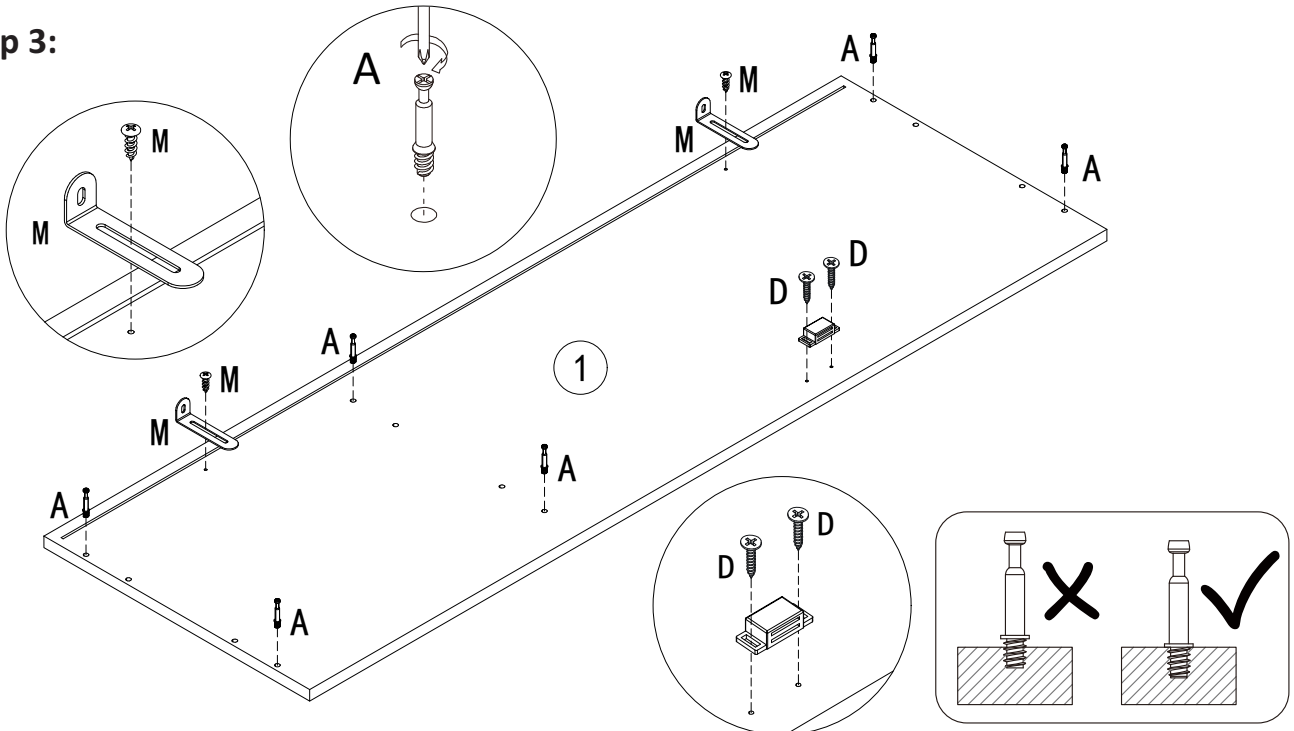

Step 4:

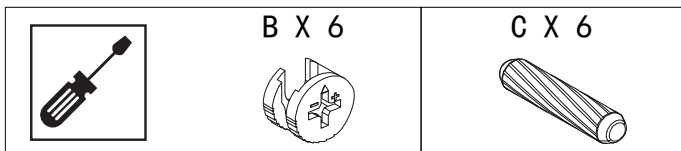
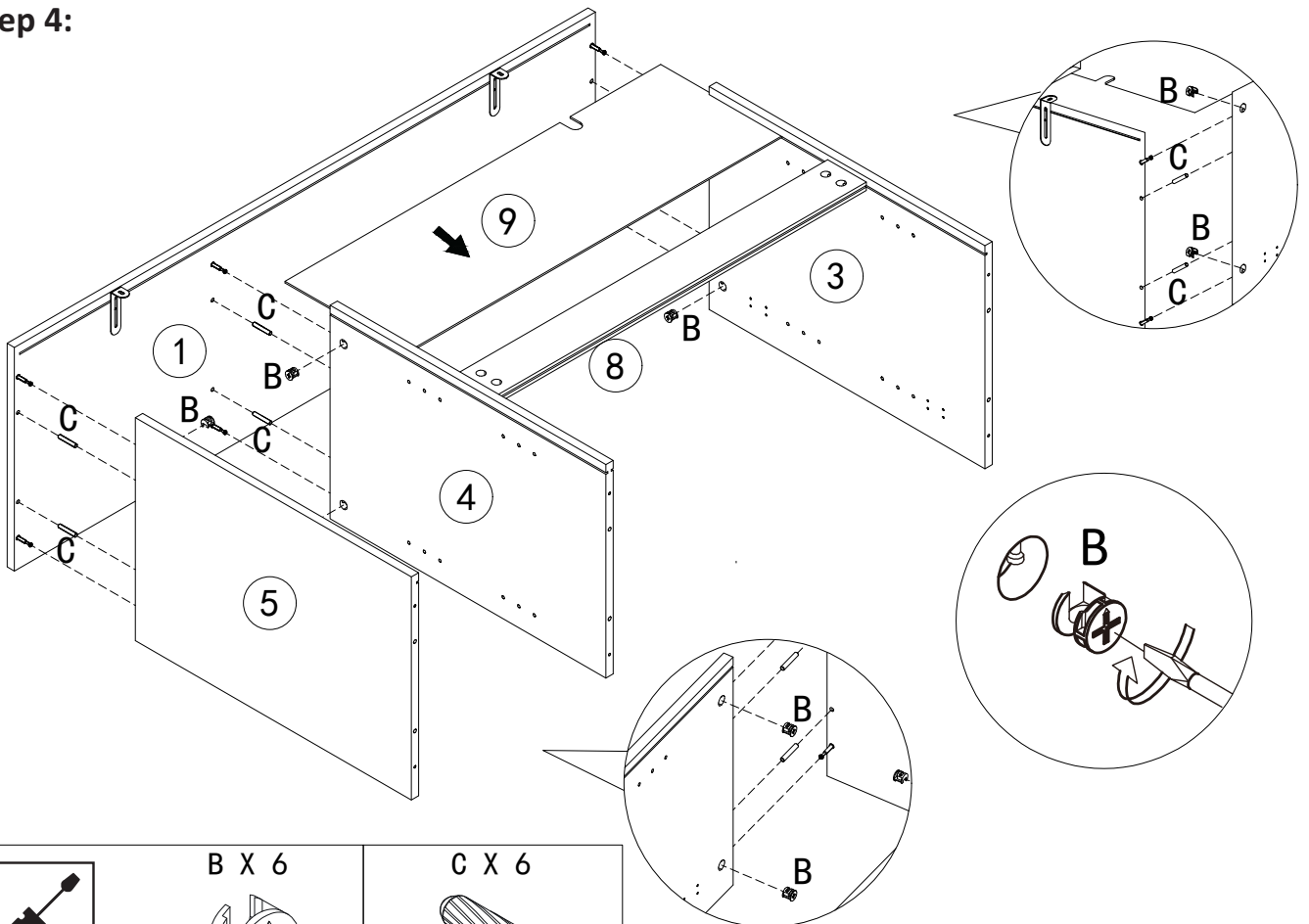

Step 5:

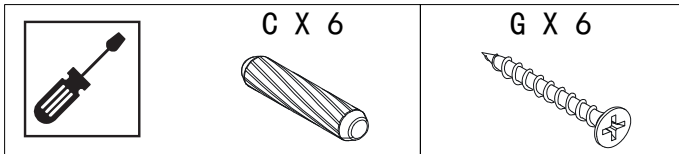
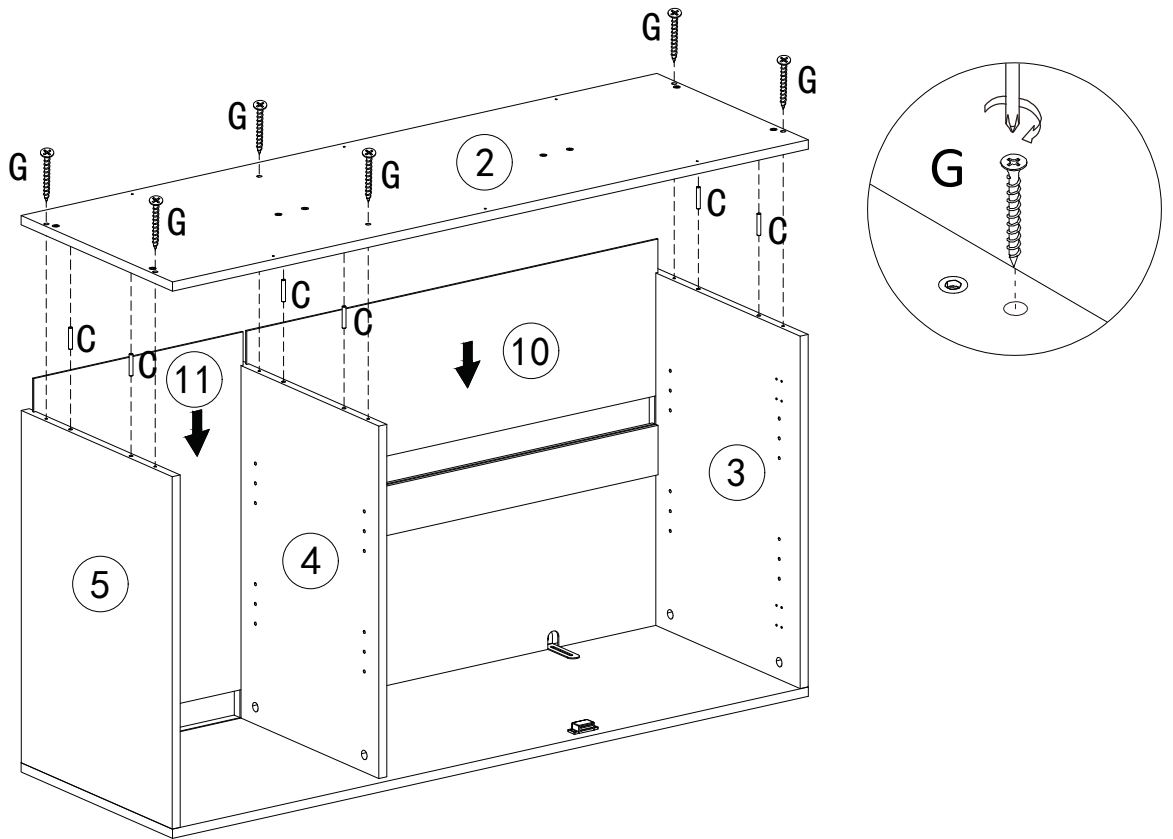

Step 6:

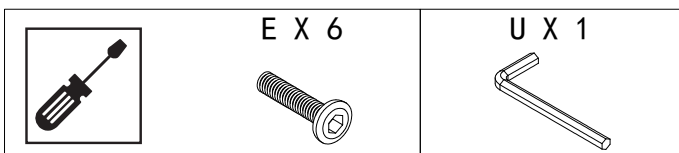
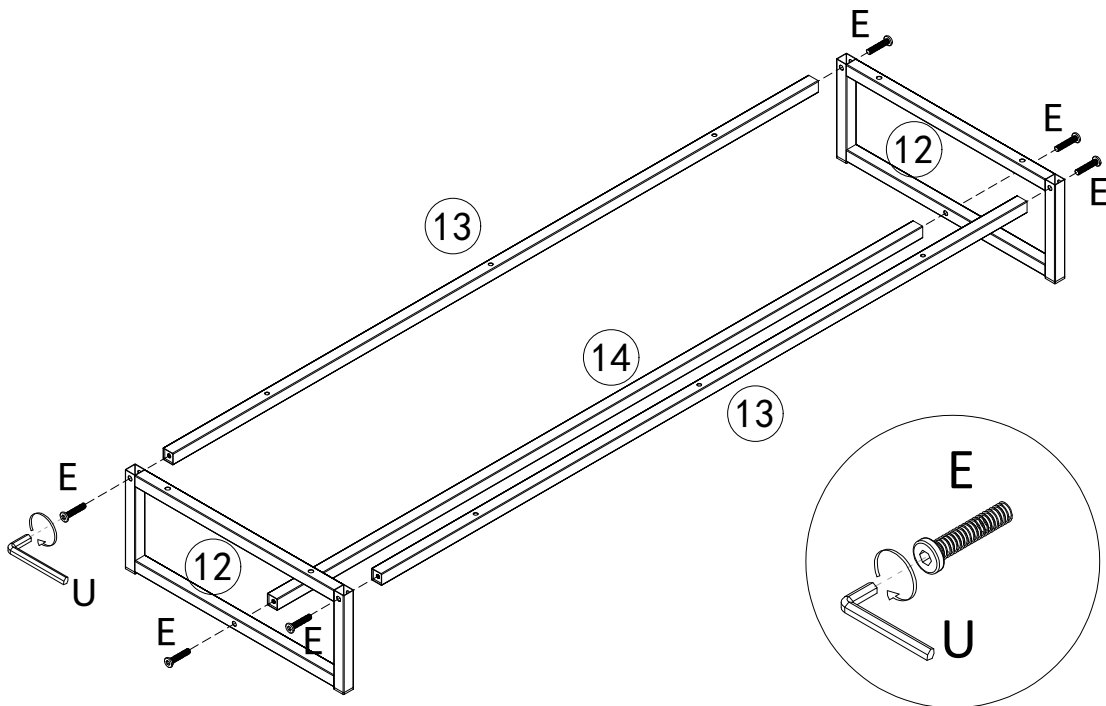

Step 7:

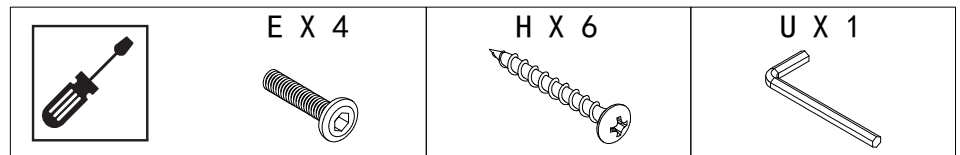
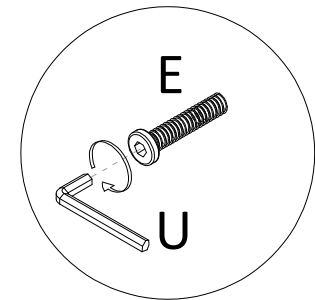
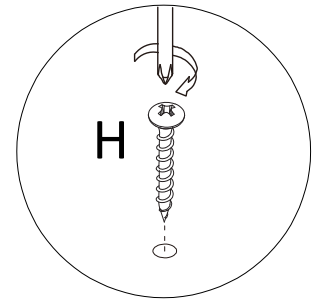
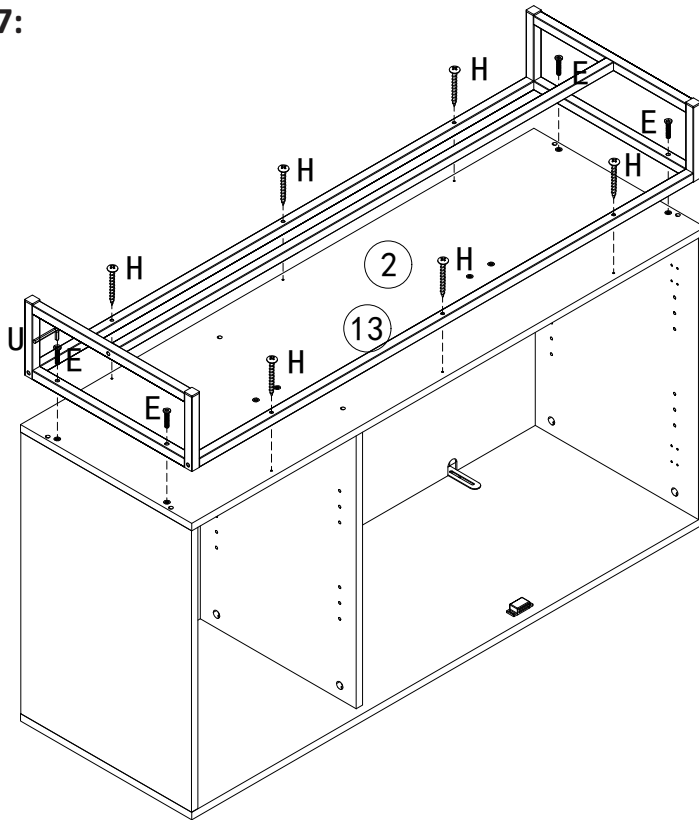

Step 8:

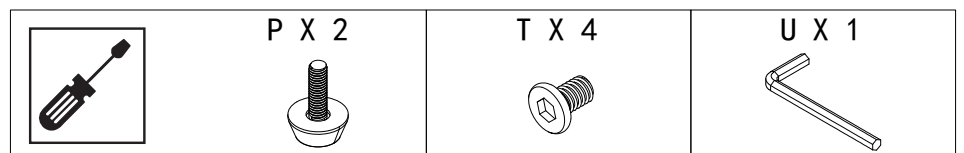
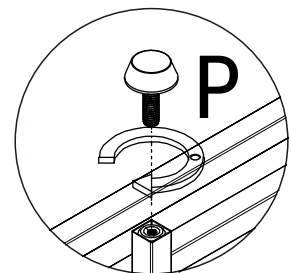
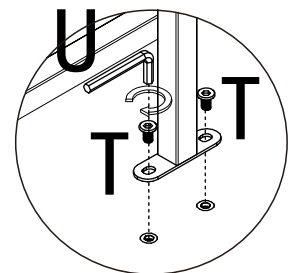
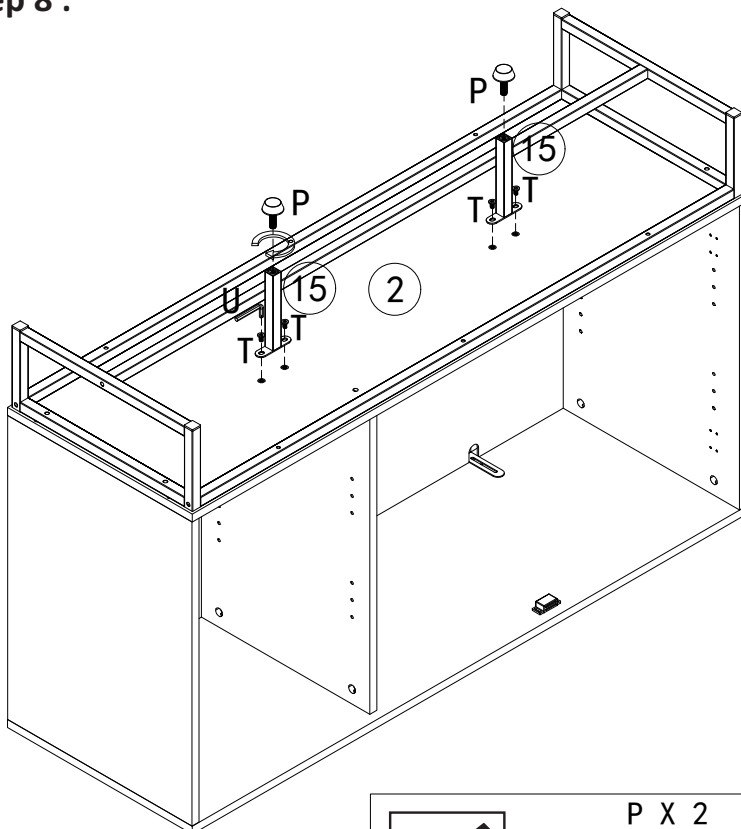

Step 9 :

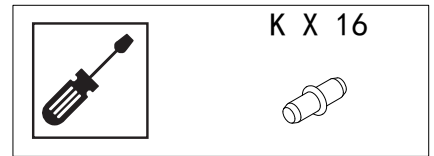
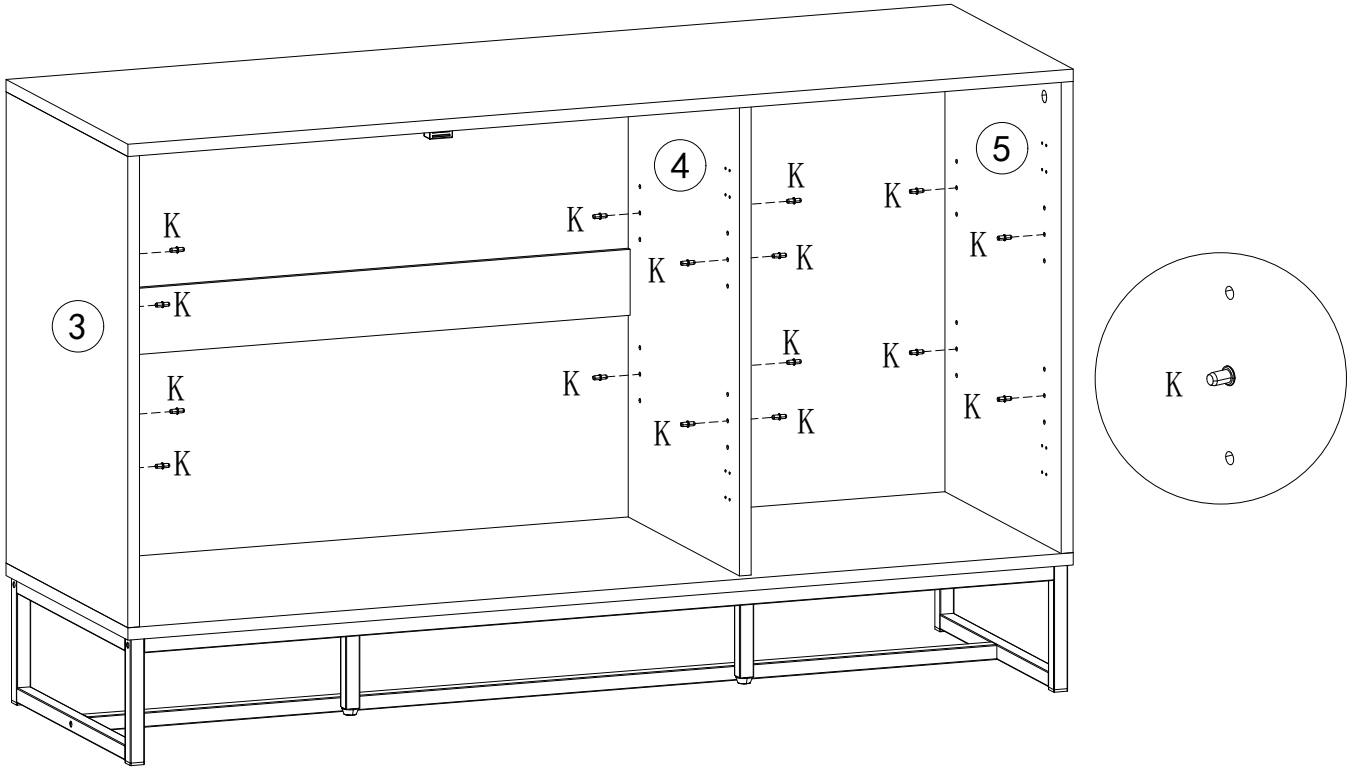

Step 10:

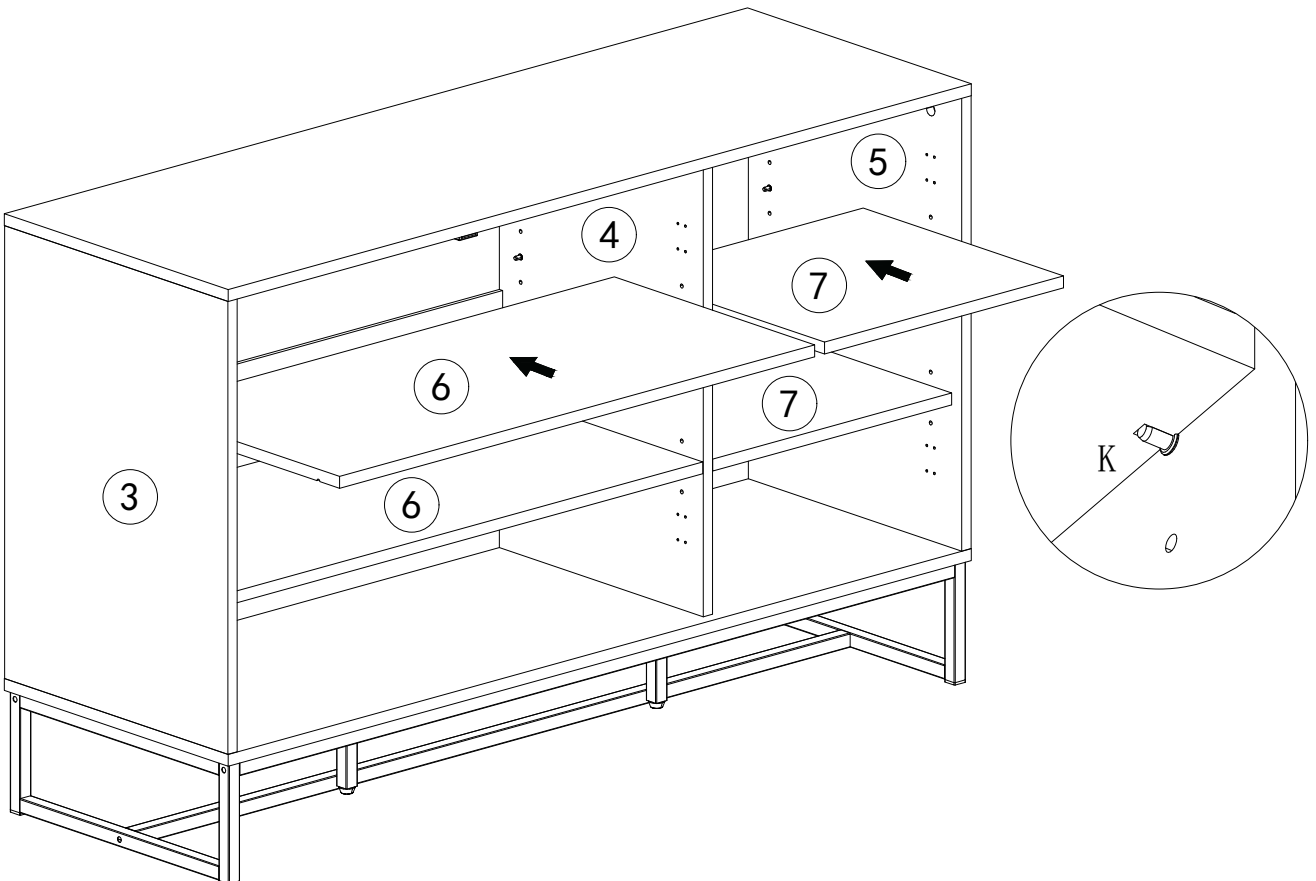

Step 11:

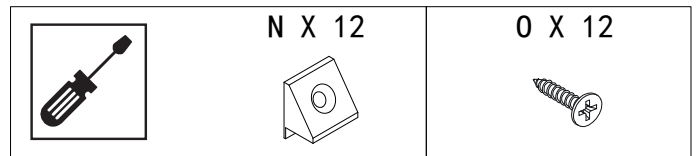
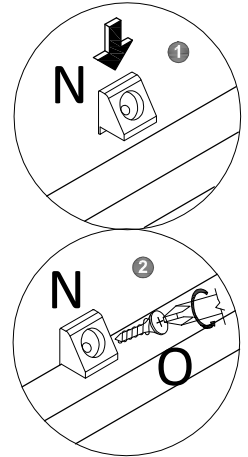
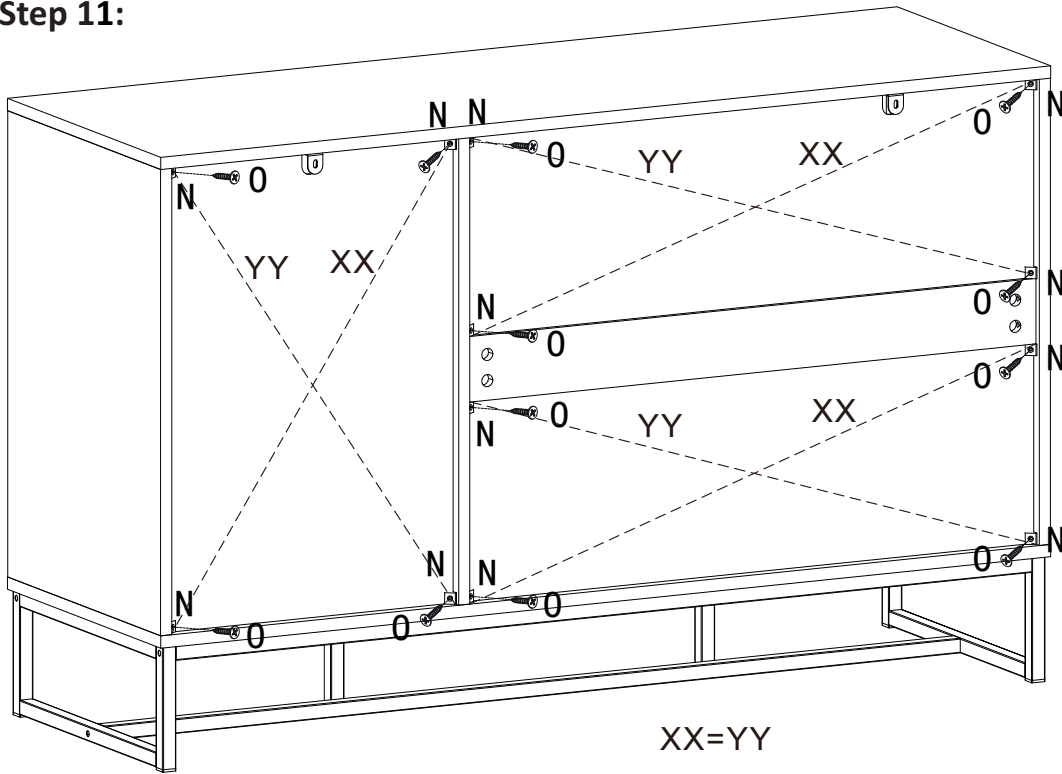

Step 12:

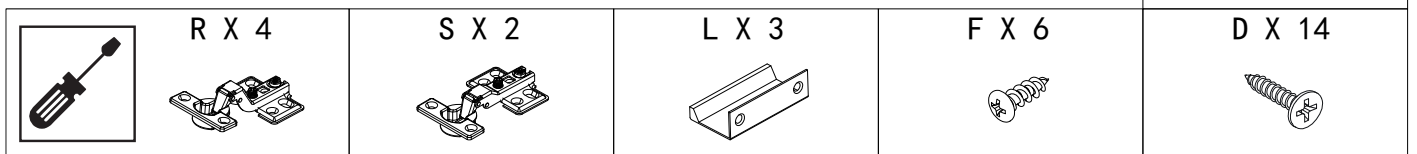
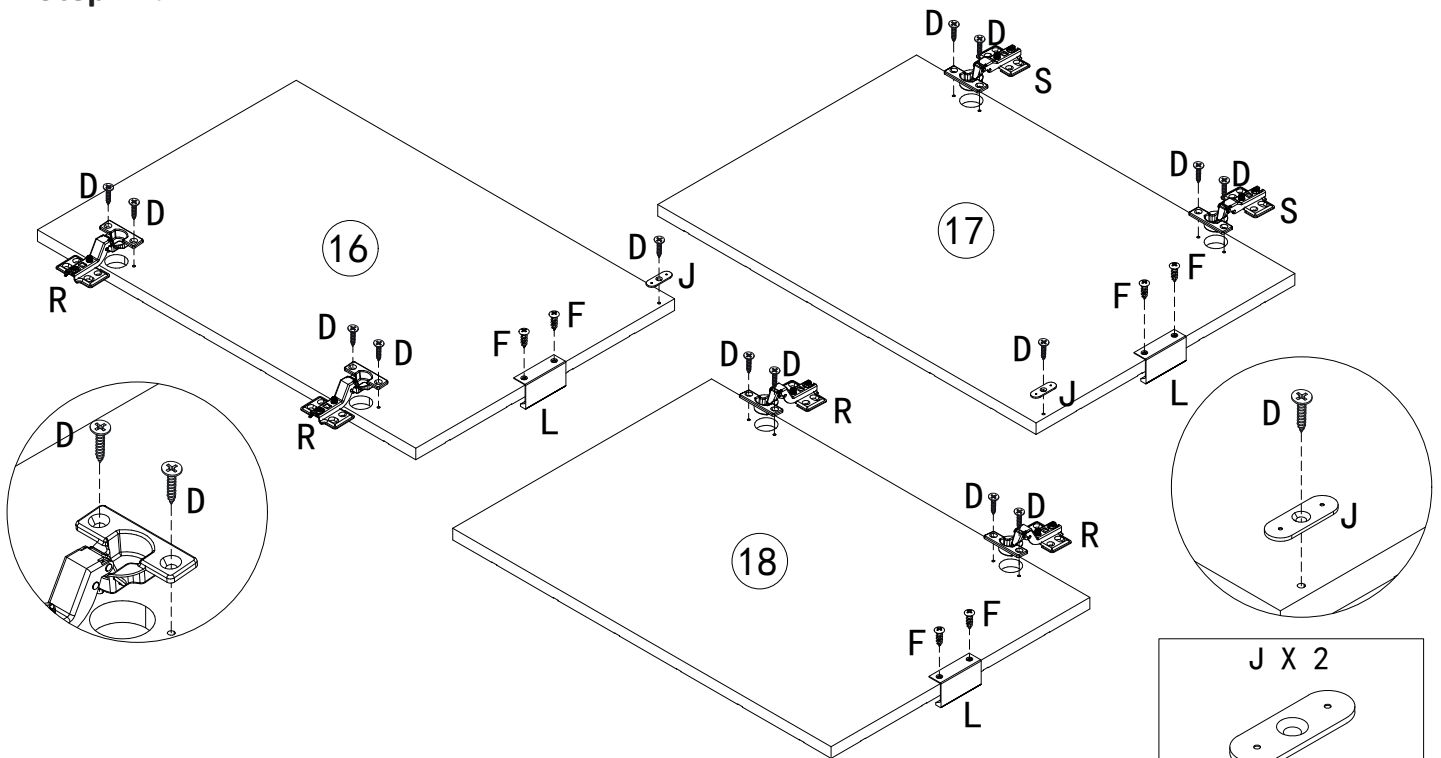

Step 13:

- This wall fixing is provided for your safety and we recommend that once in position the unit is secured to the wall for extra stability.
- Wall fixings may vary depending on item of furniture purchased.
- Wall fittings are not provided as different wall types require different wall plugs and screws.
- Please ensure that you use fittings that are suitable for your wall type (see previous page for a general guide).
- Please ensure that the head of the screws used has a diameter greater than the diameter of the hole on the wall fixing and that the fixing is safe and secure before using.
- When drilling into the walls, always ensure there are no hidden wires or pipes.
- If you are unsure, we recommend you consult a qualified Trades person.

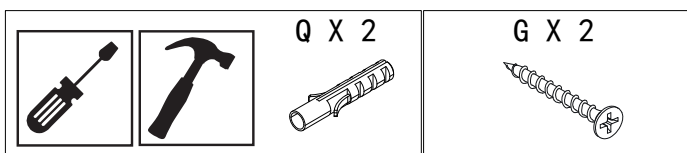
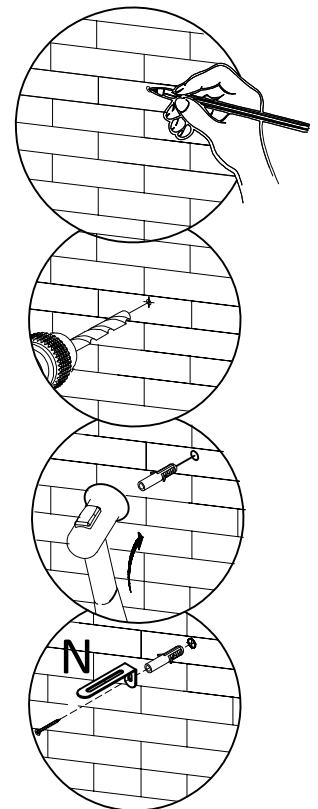
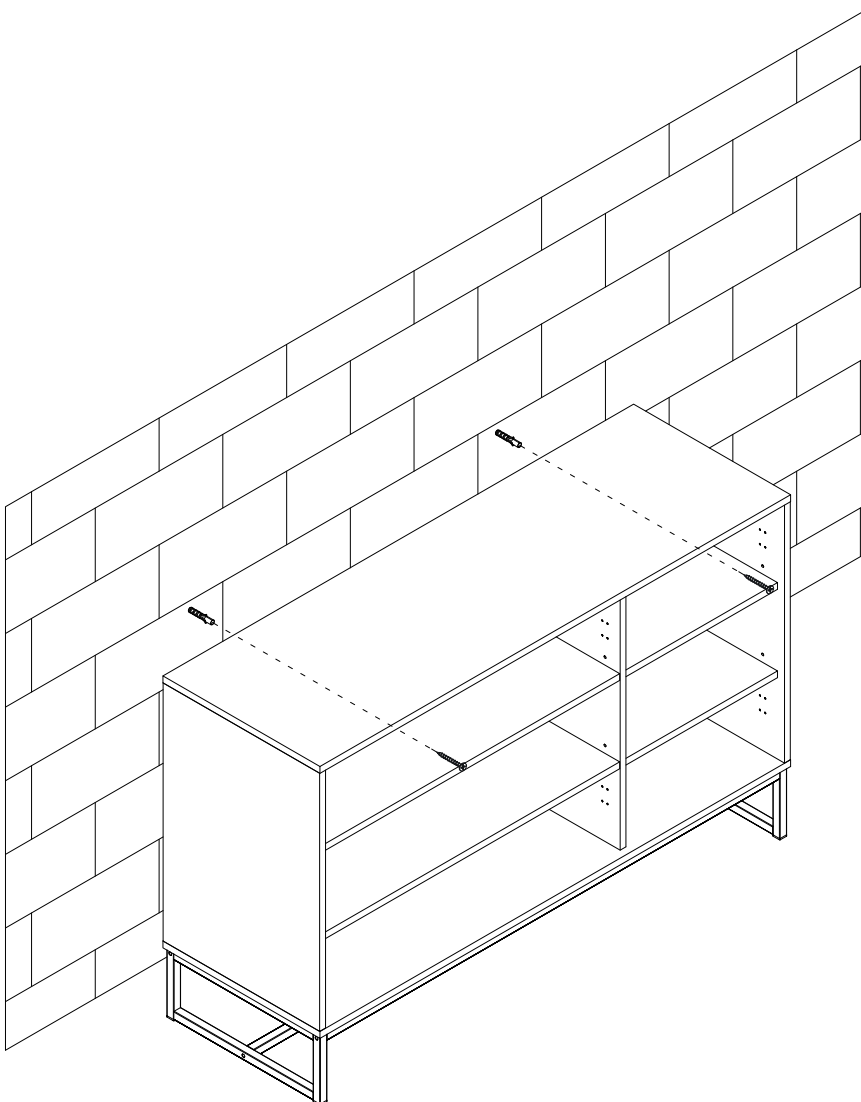

Step 14:

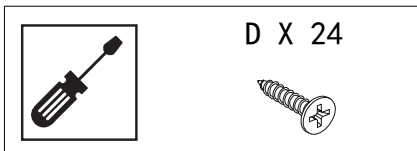
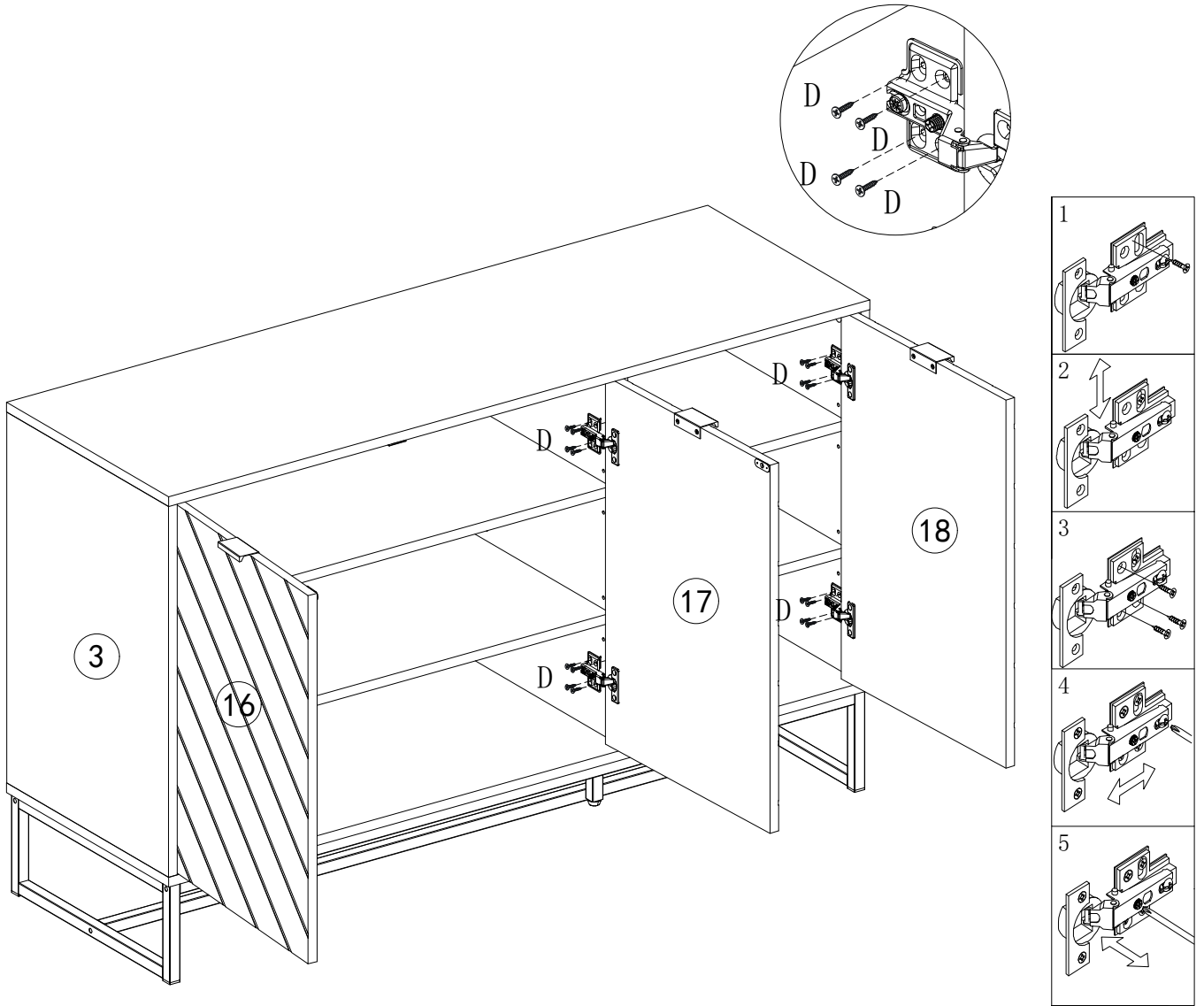

Tip Kit Instructions

Your item of furniture has been provided with a wall attachment for your safety. It is highly recommended that this is used to prevent furniture tipping over which can cause serious or fatal crushing injuries.

- Never allow children to climb or hang on the drawers, doors or shelves.
- Place the heaviest items in the lower drawers or shelves.
- Never open more than one drawer at a time.
- A suitable attachment device is provided with your product; however, you will need to source suitable fixings for your wall.
- If in doubt, please consult a qualified tradesperson.
- Two different wall fixing types could be provided with our furniture. The correct type to suit your furniture is provided in an included plastic bag. Further information below.

Plastic cable tie image

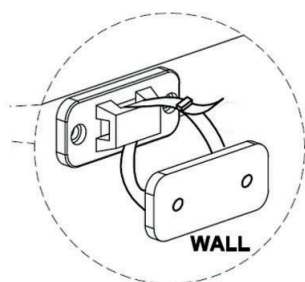

- Please ensure that the plastic bracket is screwed into the wall as the image shows.
- Wall screws and plugs are not provided however please use our guide to help you choose the correct screw / plug type for your wall.
- When drilling the walls, always ensure there are no hidden wires or pipes.

Metal L bracket image

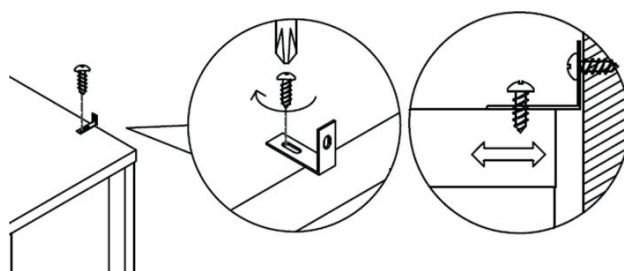

- Please ensure that the Metal L bracket is screwed into the wall as the image shows, the bracket location may vary on unit location and personal preference.
- Wall screws and plugs are not provided however please use our guide to help you choose the correct screw / plug type for your wall.
- When drilling the walls, always ensure there are no hidden wires or pipes.

Wall Fixings

Step by step

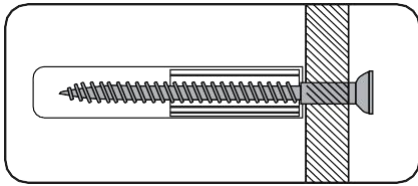

Important

When drilling into walls always check there are no hidden wires or pipes etc. Make sure that the screws and wall plugs being used are suitable for supporting your unit. Consult a qualified tradesperson if you are unsure.

Hints

1. General Rule; Always use a larger screw and wall plug if you are not sure.
2. Ensure you use the recommended drill bit to match the wall plug and hole size.
3. Ensure you drill the hole horizontally, do not force the drill or enlarge the hole.
4. Take extra care when drilling high walls, ceilings and ceramic tiles. Ensure the plug is fitting below the ceramic tile to avoid splitting or cracking.
5. Ensure wall plugs are well fitted and are a tight fit in the drilled hole.

Types of Walls

You can use one of the following types of wall plug if your walls are made of brick, breeze block, concrete, stone, wood or plastic board.

1. STANDARD Wall Plug General wall materials

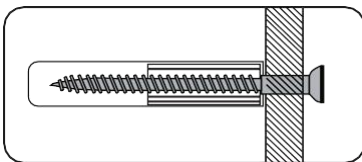

These come in various sizes and are made from plastic or sometimes wood fibre.

2. GENERAL PURPOSE Wall Plug

Aerated/Breeze block

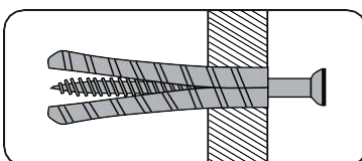

Generally aerated blocks should not be used to support heavy loads, use a specialist fitting in this case. For light loads, a General Purpose Plug can be used.

3. SHIELD ANCHOR Wall Plug Heavy loads

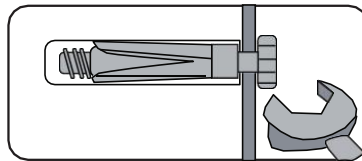

For use with heavier loads such as TV & Hi-fi Speakers and Satellite Dishes etc.

4. CAVITY FIXING Wall Plug

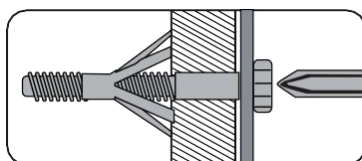

For use with plaster board partitions or hollow wooden doors.

5. CAVITY FIXING HEAVY DUTY Wall Plug

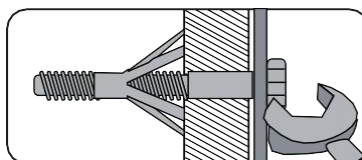

For use with plaster board partitions or hollow wooden doors.

6. HAMMER FIXING Wall Plug

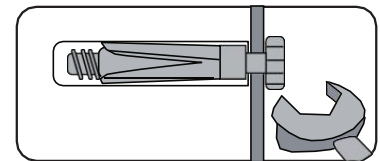

For use with walls stuck with plaster board. The hammer fixing allows it to be fixed to the wall rather than the plaster board. Always check the fixing is secure to the retaining wall.

Care and Maintenance

! Safety

Always check the fitting and location to ensure your safety in and around the home.

! Fitting

From time to time check the fitting to ensure the wall plugs or screws do not become loose.

AssemblyInstructions

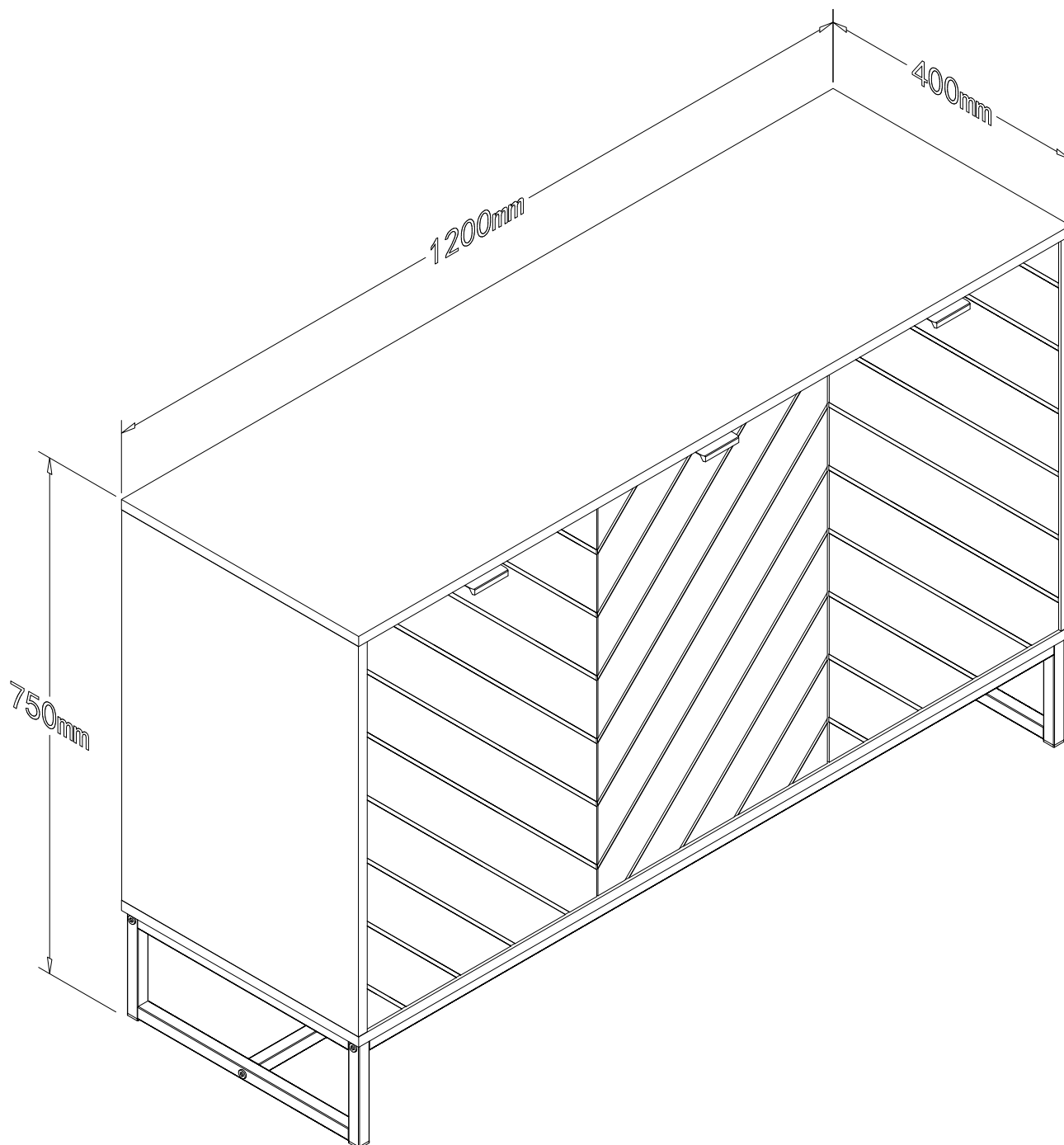

Metal Care Advice

Regular Metal Care Advice

Use a clean, dry cloth to dust the surface.

If there are stubborn marks use soapy water and a clean cloth, ensure that the water does not touch any other parts of the product. Afterwards use clean, dry cloth to remove any smears.

Do not use abrasive cleaners or cloths as these can scratch the surface of the metal.

Do not use chemical cleaners or polishes on any metal.

Ensure that mats are placed to prevent hot items coming into contact with the surface.

Wood Care Advice

Wood care advice

Wood is a natural product and each piece is individual.

As a natural product, wood is affected by temperature and humidity. We recommend that you avoid placing the furniture directly in front of heat sources such as radiators or fires or in humid areas such as bathrooms or next to bathrooms as this can cause cracking or warping over time.

The colour will mellow over time and new items can vary in shade from items that you have already purchased.

Strong direct sunlight can affect the colour dramatically, so try to avoid this as much as possible, we also recommend that any ornaments, coasters and items placed on the product are periodically moved around to allow the colour to mellow evenly.

Always use mats and coasters to protect the surface when placing items on the furniture. This will help to protect the finish from heat, liquids or items that might scratch your furniture. Additionally, if writing on your product, use a mat or pad so protect the surface.

If items are to be placed on the surface of your furniture and have rubber feet, it is advisable to use mats to prevent marking.

Always lift your furniture into place, avoid dragging it across the floor as this can cause damage to joints.

When placing furniture on a wooden or laminate floor, please ensure that the plastic or felt protectors are securely fitted and in place.

Avoid rocking backwards on two legs of the chair as this will weaken the joints

Only clean using a damp cloth and mild detergent, do not use bleach or abrasive cleaners.

From time to time check that there are no loose screws on this unit.

Wood can absorb liquids, for this reason, remove any spills immediately to avoid staining.

When mopping the floor around where your chairs and stools are placed avoid getting the legs too wet.

Dust regularly with a soft lint free cloth or duster.

The use of abrasive polish or silicon-based polishes is not advised as these can affect the polished finish and joints over time.

Ensure the polish you are using is correct for your product as some polishes can degrade protective layers on furniture.

Ensure you patch test a polish or cleaning product on a discrete area before applying it to the whole product.

Uneven floors could give the impression that doors of wall units and wardrobes are out of alignment. Be aware of this and compensate if necessary, by adjusting the hinges or packing a corner to level the item. Please refer to the instructions, included with your furniture, and adjust accordingly.

If your furniture becomes stained, scratched, chipped or suffers other damage, we recommend professional help is sought to restore it. Please contact our customer services line for recommended agents.

Periodically, check the tightness of fixings and tighten if necessary.

Always follow fitting instructions carefully and retain them for future use.

Finally, we hope you enjoy your furniture for many years to come and thanks again for your purchase.