

Upholstery care advice

Regular care advice

Vacuum clean your upholstery at least once a week, dust removal may be improved by pre-brushing with a soft cloth.

All reversible cushions should be turned daily and their positions switched, this will help prevent excessive soiling and even out wear.

Cushion care

It is essential that all fibre cushions are given a vigorous plumping by shaking and squeezing to redistribute the fibre on a daily basis. This will add air back into the fibres to prevent the fibre from going flat and lumpy.

General care advice

For items with wooden legs/ feet never place on a damp floor.

Keep upholstery out of direct sunlight to avoid discolouring.

Do not place the furniture in a conservatory, excessively dry or humid conditions.

Avoid sharp items such as toys, jean rivets and buckles coming into contact with the upholstery as these can easily snag, tear or pull the fabric.

**Produced in China for Dunelm (Soft Furnishings) Ltd. LE7 1AD & Dunelm (Soft Furnishings) Londonderry Ltd. BT48 8QN
www.dunelm.com**

For accidental spills or stains

Don't rub or scrub with a cloth as this could damage the fabric and remove the colour.

Don't use washing up liquid, detergents or bleach to remove stains.

Don't soak or allow fabric to become wet.

Do blot or soak up spills immediately using a dry soft colourfast cloth.

Do use specialist upholstery cleaner if needed, always follow the manufacturer's instructions and always test on a hidden area to check colour fastness. Allow the test patch to completely dry first. If the fabric colour is affected, do not use this cleaner on the rest of your product and consult a specialist.

Finally, we hope you enjoy your furniture for many years to come and thanks again for your purchase.

Jesper Barstool

INSTRUCTIONS

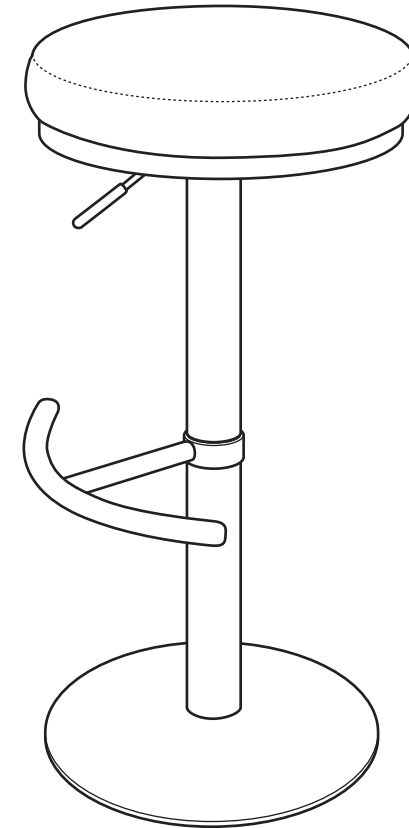

Care advice

Check the pack and make sure you have all the parts listed below. If not, contact the helpline on **03451 656565** who will be able to help you

Safety advice

IMPORTANT - The first step you need to take is to ensure your safety! Please take the time to read and understand these instructions before assembling your furniture.

Please keep these instructions for future reference.

Keep children and animals away from the assembly area. This furniture contains small parts that could cause choking if swallowed.

Keep all plastic wrapping materials away from babies and children to avoid danger of suffocation. Ensure that all packaging is disposed of carefully and responsibly.

From time to time check that there are no loose fittings on the unit, re-tighten when necessary.

Two people may be required for the assembly of this product.

Once items are part or fully assembled, they are not returnable unless faulty.









This item is not for outdoor use – unless stated otherwise.

Some items will be supplied with a wall fixing strap, which we recommend is used to secure the item

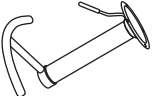
to the wall, to prevent a child from accidentally pulling furniture over. Furniture can be dangerous if incorrectly installed. Assembly should be carried out by a competent person. No liability will be accepted for damage or injury caused by incorrectly installed or assembled furniture.

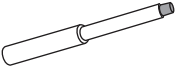
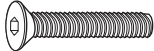
Parts and fittings

Please ensure correct size screw is selected for each assembly step.

Ref	Dimensions	Visual	Qty	Ref	Dimensions	Visual	Qty
1	33x33x9.5cm		1	A	M6X18mm		4
2	33x23x40cm		1	B	N/A		4
3	5x5x47/70cm		1	C	M8X30mm		3
4	39x39x0.6cm		1	D	N/A		1
				E	N/A		6

Step 7:

Assembly complete.

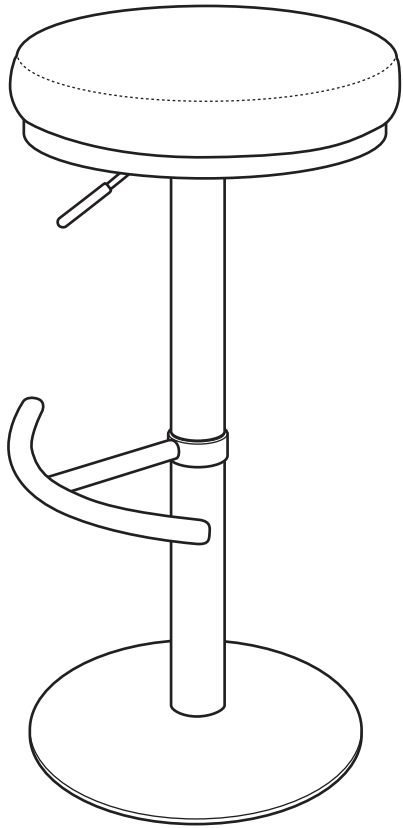

Step 1:

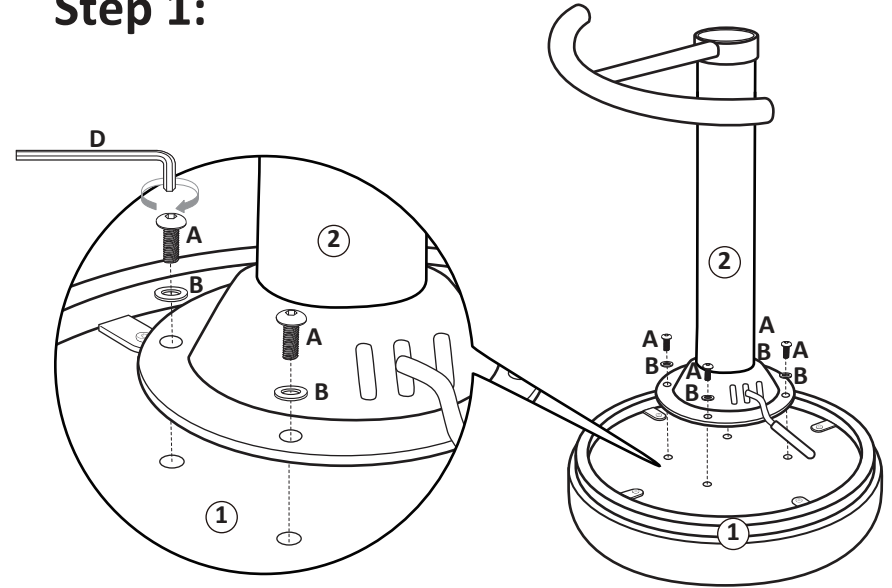

Step 2:

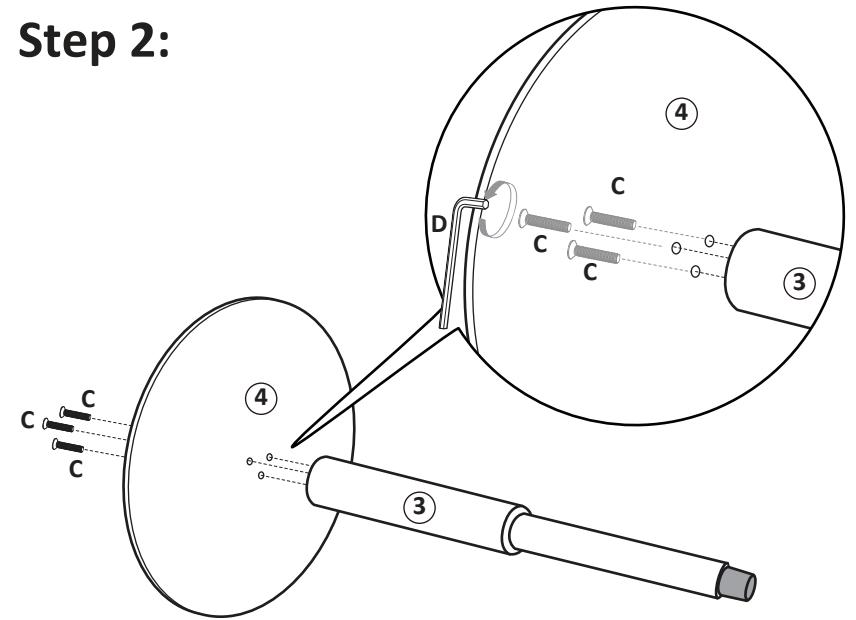

Step 3:

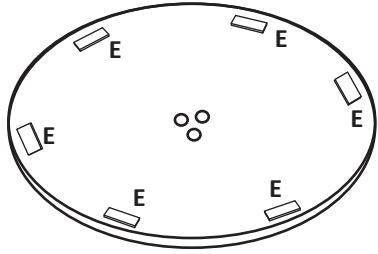

Step 4 :

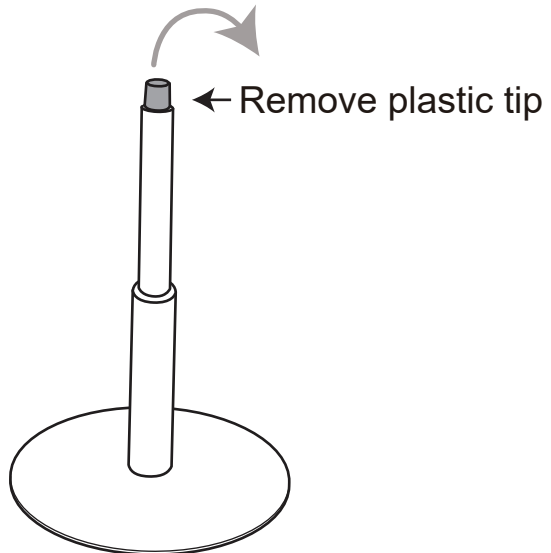

Step 5:

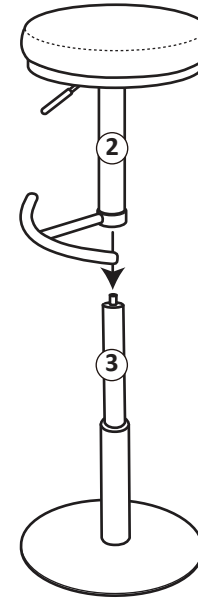

Step 6:

