

Knockerback Chair Assembly Instructions

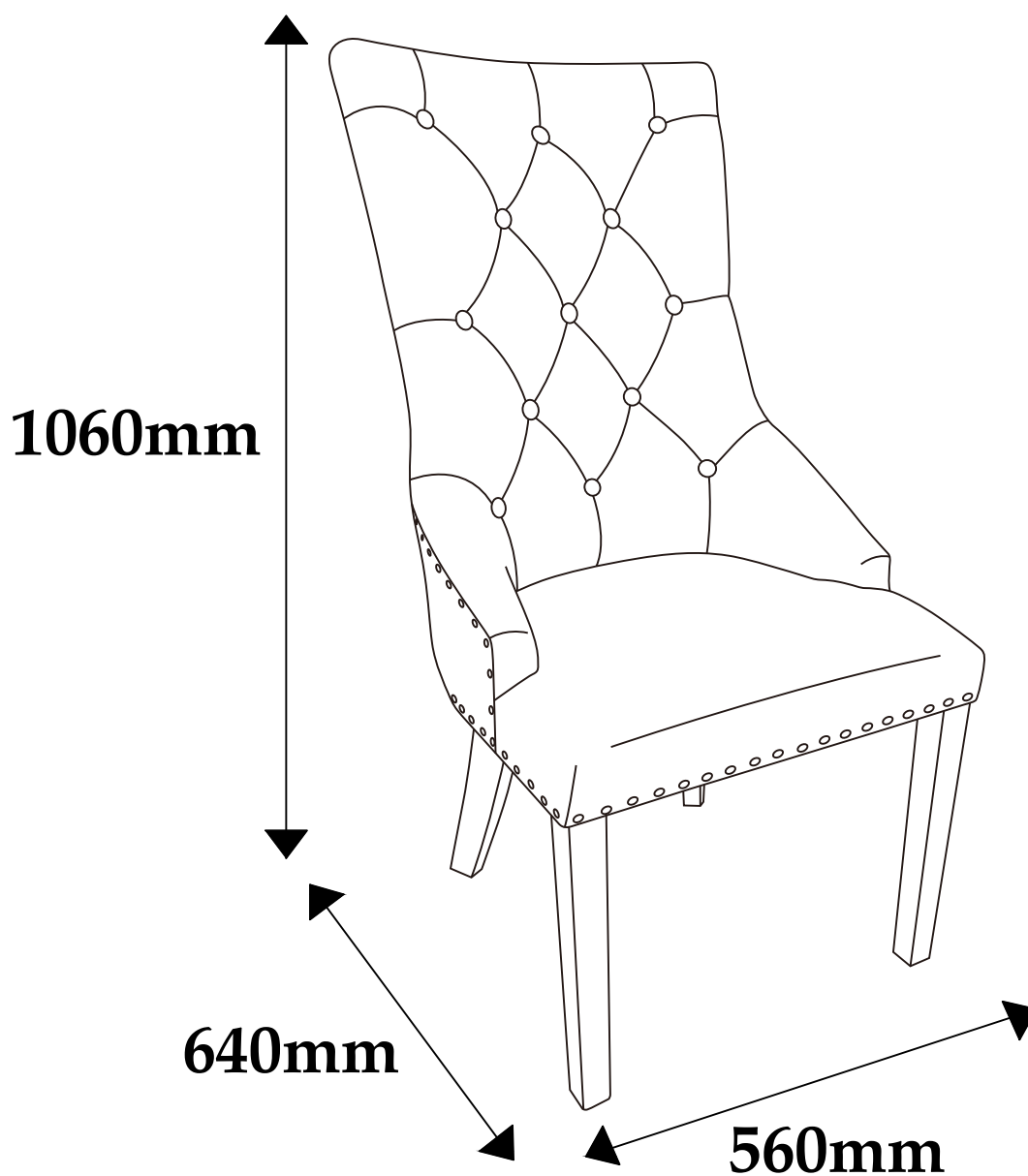

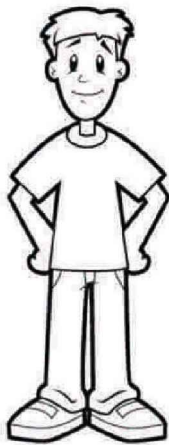

No Extra
Tools Required

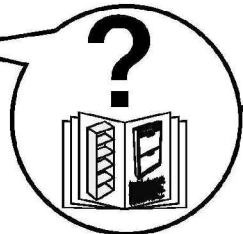
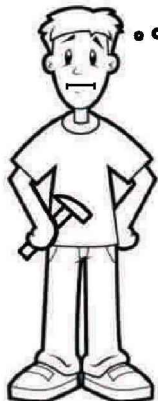
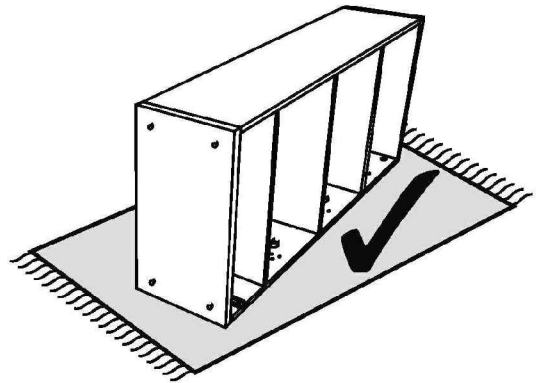
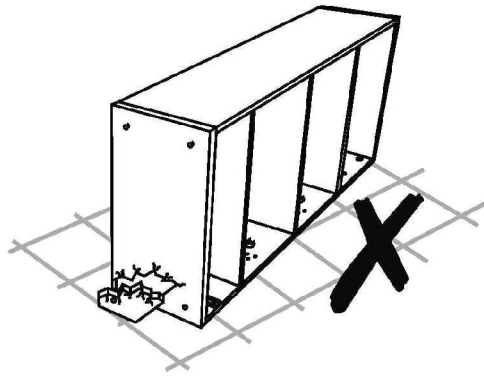
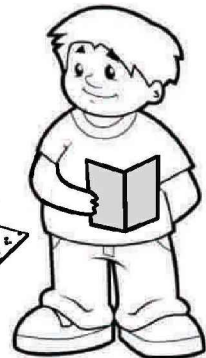
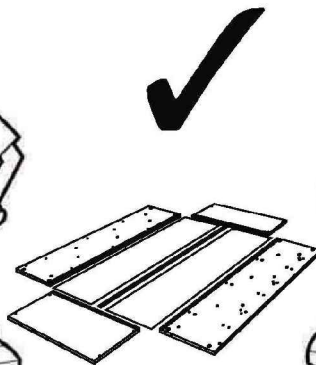
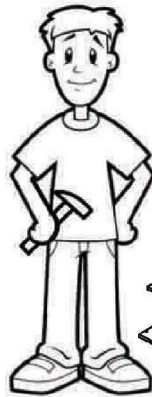
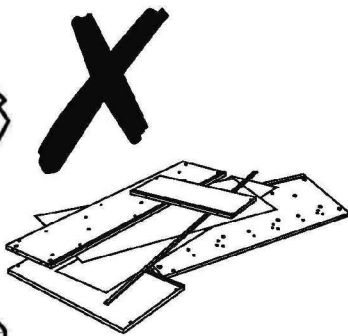
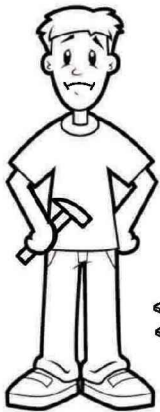
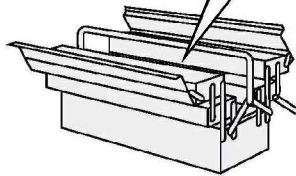

Customer Service
(01623 727374)

HARDWARE

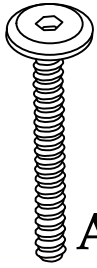

A

M8 x 55 MM = 8



B

FLAT WASHER
M8 x 22 MM = 8

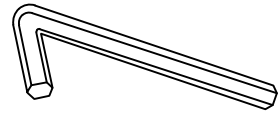

C

ALLEN KEY M8 = 1

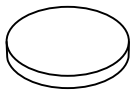

D

25MM x 25MM = 4

PARTS

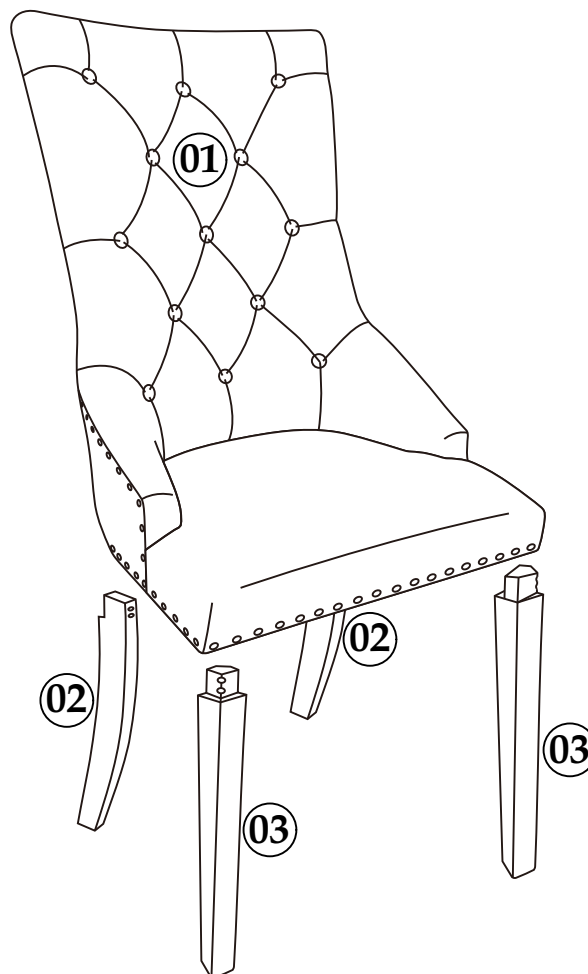

Safety Advice

Please take the time to carefully read through the whole of these instructions before you commence.

Keep these instructions for future reference.

Unpack, inspect and check off all of the contents.

Please dispose of all packaging safely.

Small component parts could choke a child if swallowed.

We strongly recommend that you keep children well away from the work area.

It would be sensible to lay a sheet or blanket on the floor where you intend to work to avoid scratching this product and to protect your floor.

This product is heavy. Take extreme care when lifting to avoid personal injury or damage to the product.

Assemble the product as close to its intended final position in the room as possible.

HANDY HINT: If you keep the hardware in a bowl during assembly you will be less likely to lose them.

We strongly urge that you do not use Power Tools, such as drills or electric screwdrivers during this assembly as this could cause irreparable damage to your product and will invalidate the warranty.

1

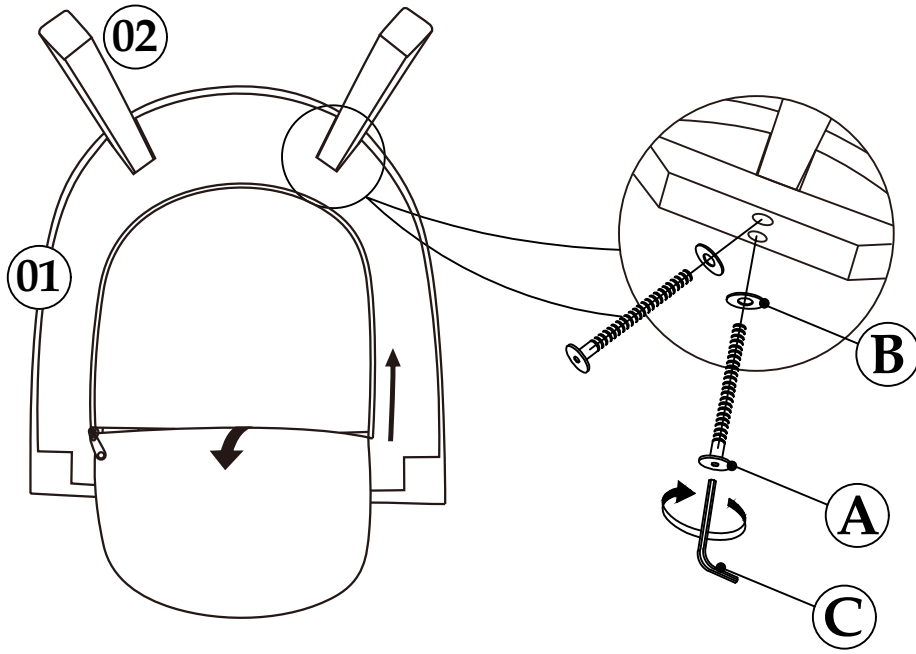

Please do not fully tighten any bolts until the final step.

2

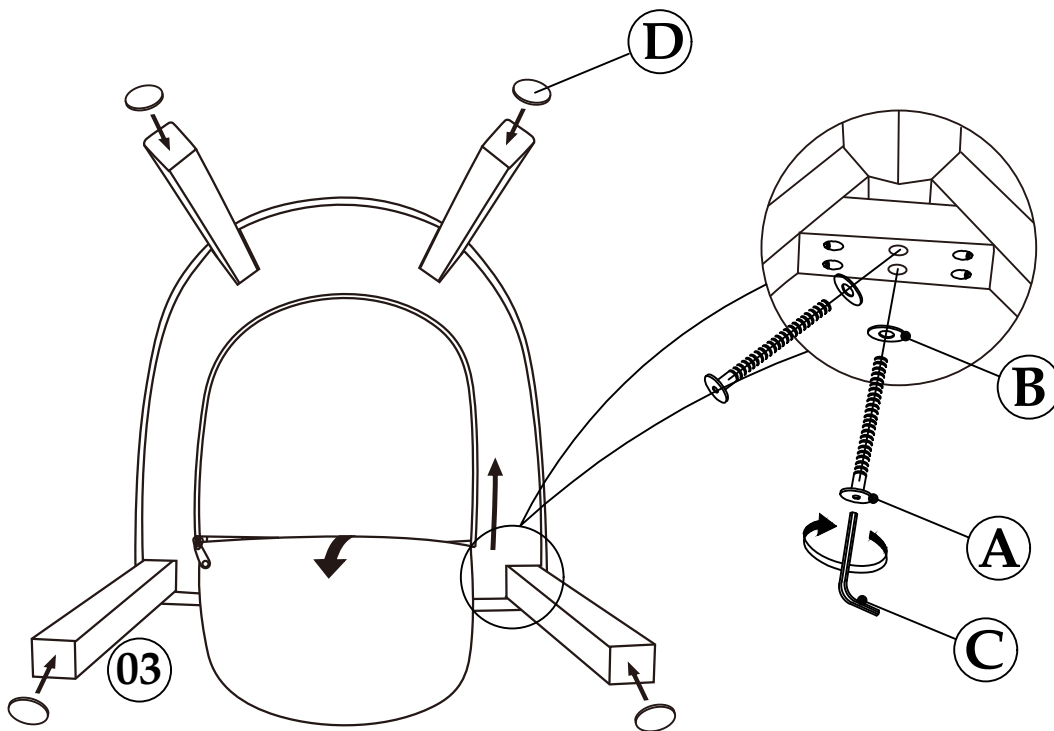

3

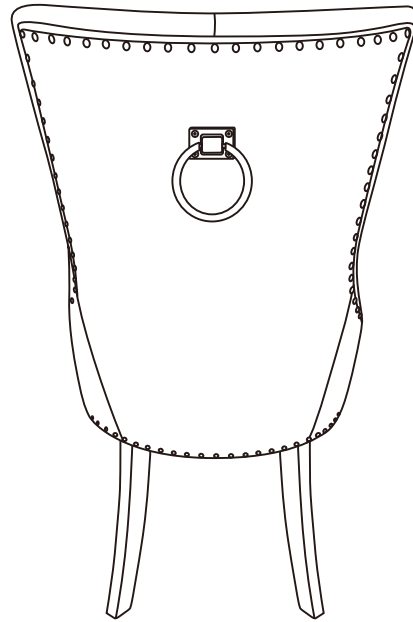
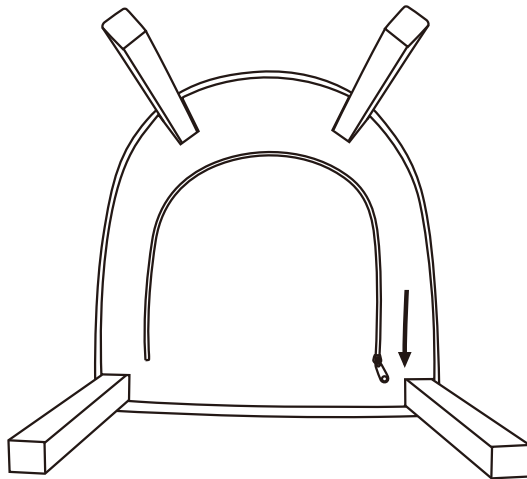

IMPORTANT Carefully turn the chair upright and place on a flat surface. Make adjustments to ensure that the chair frame is straight and that the legs are even on the floor then **FULLY TIGHTEN ALL BOLTS** assembled in previous steps using Allen key (C).

4

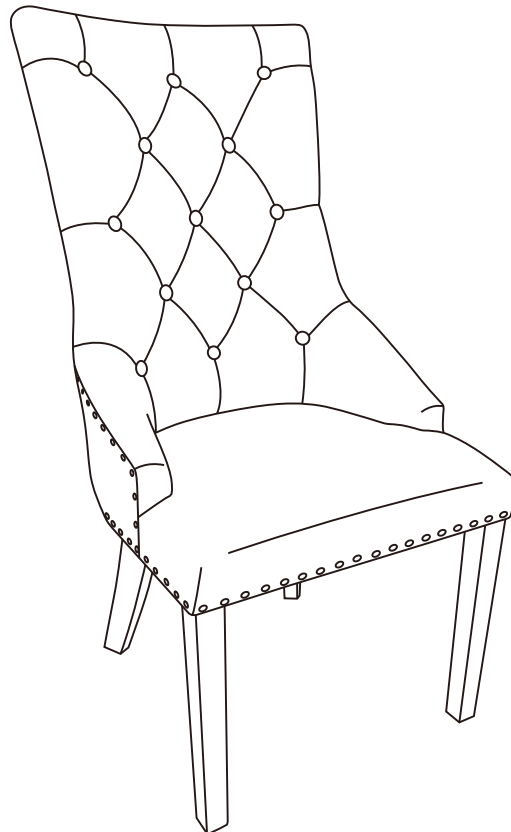

General Care

Wipe clean with a slightly damp soft cloth.

Avoid the use of all household cleaners and abrasives.

When moving your furniture, carefully lift into place.

Never drag or push the pieces across the floor as this will cause damage to the joints and could result in failure to the product that will invalidate the warranty.

Recommendations

Periodical re-tightening of fixings.

Notes

We've tried to make this piece of furniture as easy to assemble as possible.

In the unlikely event that you have problems putting it together or have damaged or missing pieces, please contact our customer services on 01623 727374