

# Upholstery care advice

## Regular care advice

Vacuum clean your upholstery at least once a week, dust removal may be improved by pre-brushing with a soft cloth.

All reversible cushions should be turned daily and their positions switched, this will help prevent excessive soiling and even out wear

## Cushion care

It is essential that all fibre cushions are given a vigorous plumping by shaking and squeezing to redistribute the fibre on a daily basis. This will add air back into the fibres to prevent the fibre from going flat and lumpy.

## General care advice

For items with wooden legs/ feet never place on a damp floor.

Keep upholstery out of direct sunlight to avoid discolouring.

Do not place the furniture in a conservatory, excessively dry or humid conditions.

Avoid sharp items such as toys, jean rivets and buckles coming into contact with the upholstery as these can easily snag, tear or pull the fabric.

To maintain the appearance and durability of your suit, restrain children and pet from climbing and jumping on the sofa.

Leather is a natural product and can display natural marks and characteristics such as healed scars, grain directions and creases. These are natural features not faults. Aniline leather will mark naturally and have a antiquar affect after years of use, this is part of the nature of the leather. Care for the leather is required to maintain it over the years

Velvet has a directional pile resulting in colour change when the pile is brushed the wrong way or when the light catches it. Velvet can easily mark and may appear crushed when new, to resolve this sweep with a clothes brush to refresh the pile. Over time the pile may crush d

## For accidental spills or stains

Don't rub or scrub with a cloth as this could damage the fabric and remove the colour.

Don't use washing up liquid, detergents or bleach to remove stains.

Don't soak or allow fabric to become wet.

Do blot or soak up spills immediately using a dry soft colourfast cloth.

Do use specialist upholstery cleaner if needed, always follow the manufacturer's instructions and always test on a hidden area to check colour fastness.

# Bude Carver Chair

## INSTRUCTION

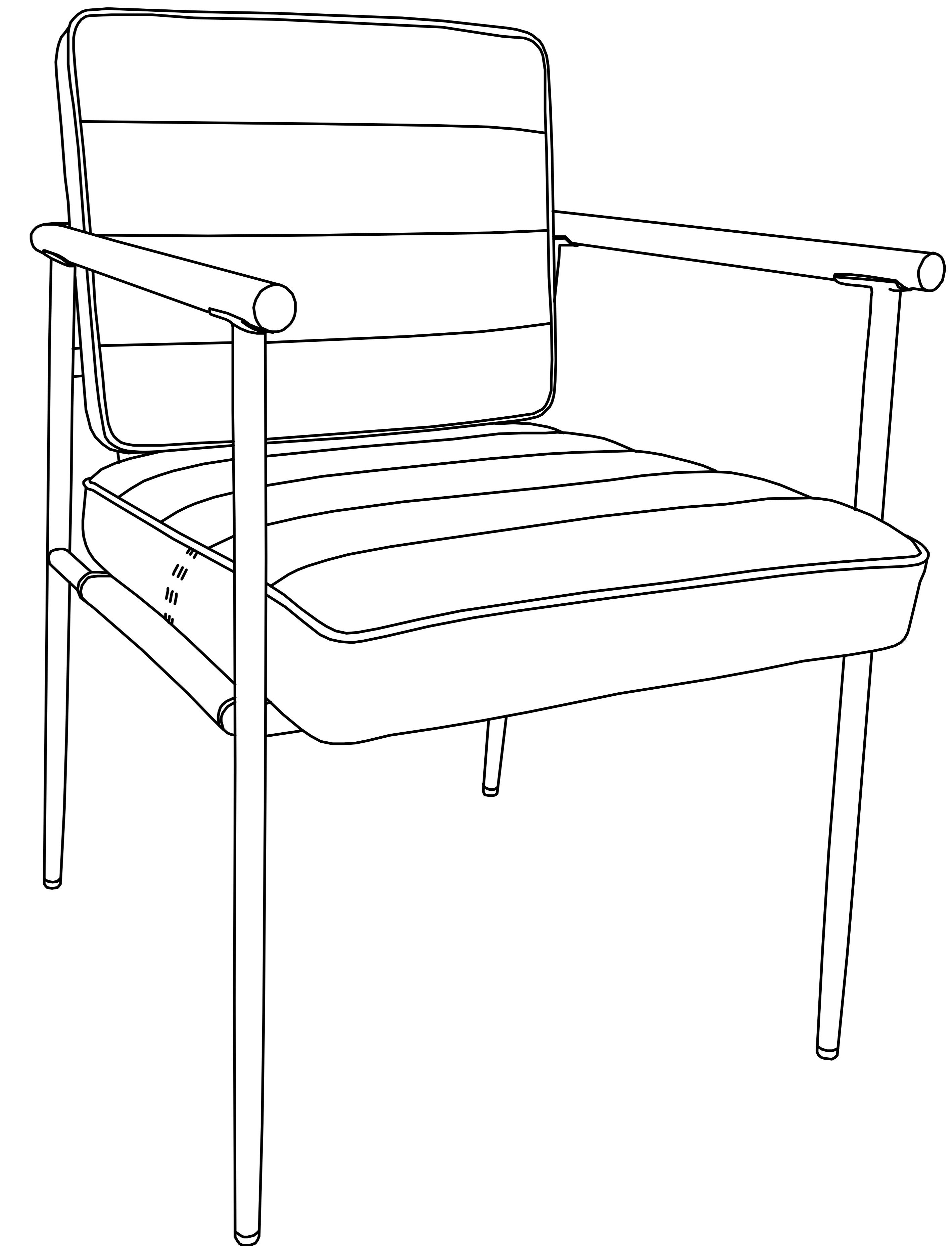

**Dunelm**  
www.dunelm.com



**Dear Customer**

Check the pack and make sure you have all the parts listed below. If not, contact the helpline on **03451 656565** who will be able to help you

**Safety and care advice**

**IMPORTANT** -The first step you need to take is to ensure your safety! Please take the time to read and understand these instructions before assembling your furniture.

Please keep these instructions for future reference. Keep children and animals away from the assembly area. This furniture contains small parts that could cause choking if swallowed.

Keep all plastic wrapping materials away from babies and children to avoid danger of suffocation.

Ensure that all packaging is disposed of carefully and responsibly.

From time to time check that there are no loose fittings on the unit, re-tighten when necessary.



Two people may be required for the assembly of this product.



Once items are part or fully assembled they are not returnable unless faulty.

This item is not for outdoor use - unless stated otherwise.

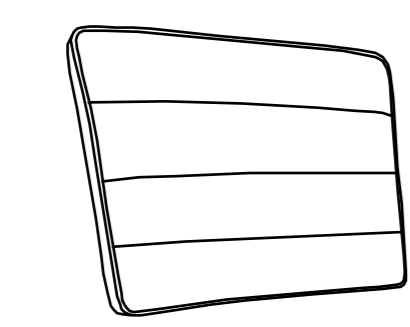
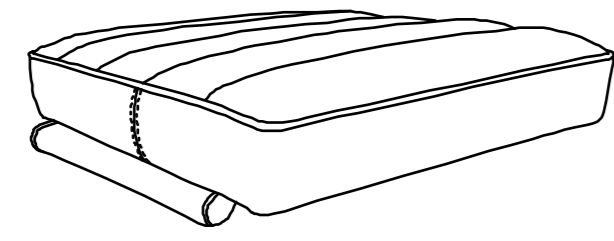
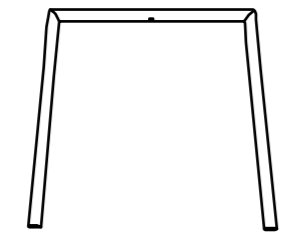
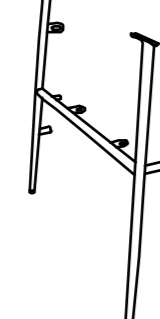
Some items will be supplied with a wall fixing strap, which we recommend is used to secure the item to the wall, to prevent a child from accidentally pulling furniture over. Furniture can be dangerous if incorrectly installed. Assembly should be carried out by a competent person. No liability will be accepted for damage or injury caused by incorrectly installed or assembled

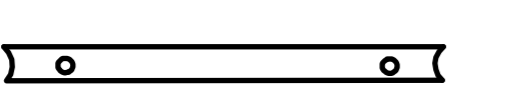
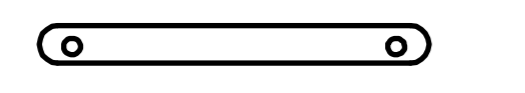
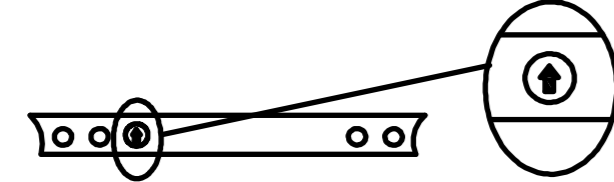
**Parts and fittings**

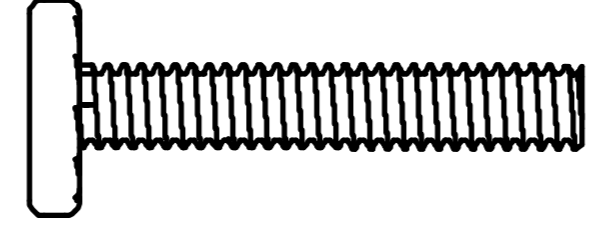
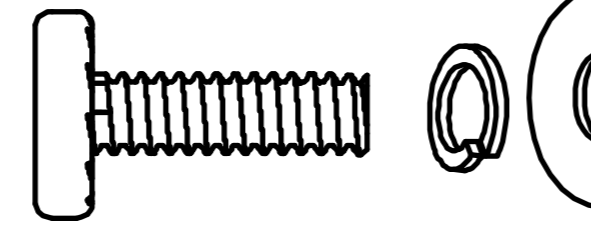
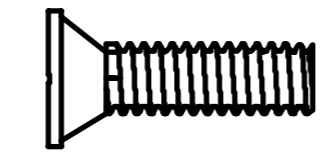
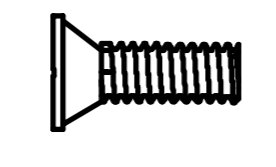
Ref	Dimensions	Visual	Qty
1	N/A		1
2	N/A		1
3	N/A		1
4	N/A		1
5	N/A		1
6	N/A		1
7	N/A		1
8	N/A		1

Ref	Dimensions	Visual	Qty
A	M6*45MM		1
B	M6*20MM M6*14*1		6
C	M6*16MM		4
D	M6*12MM		8
G	M4		1

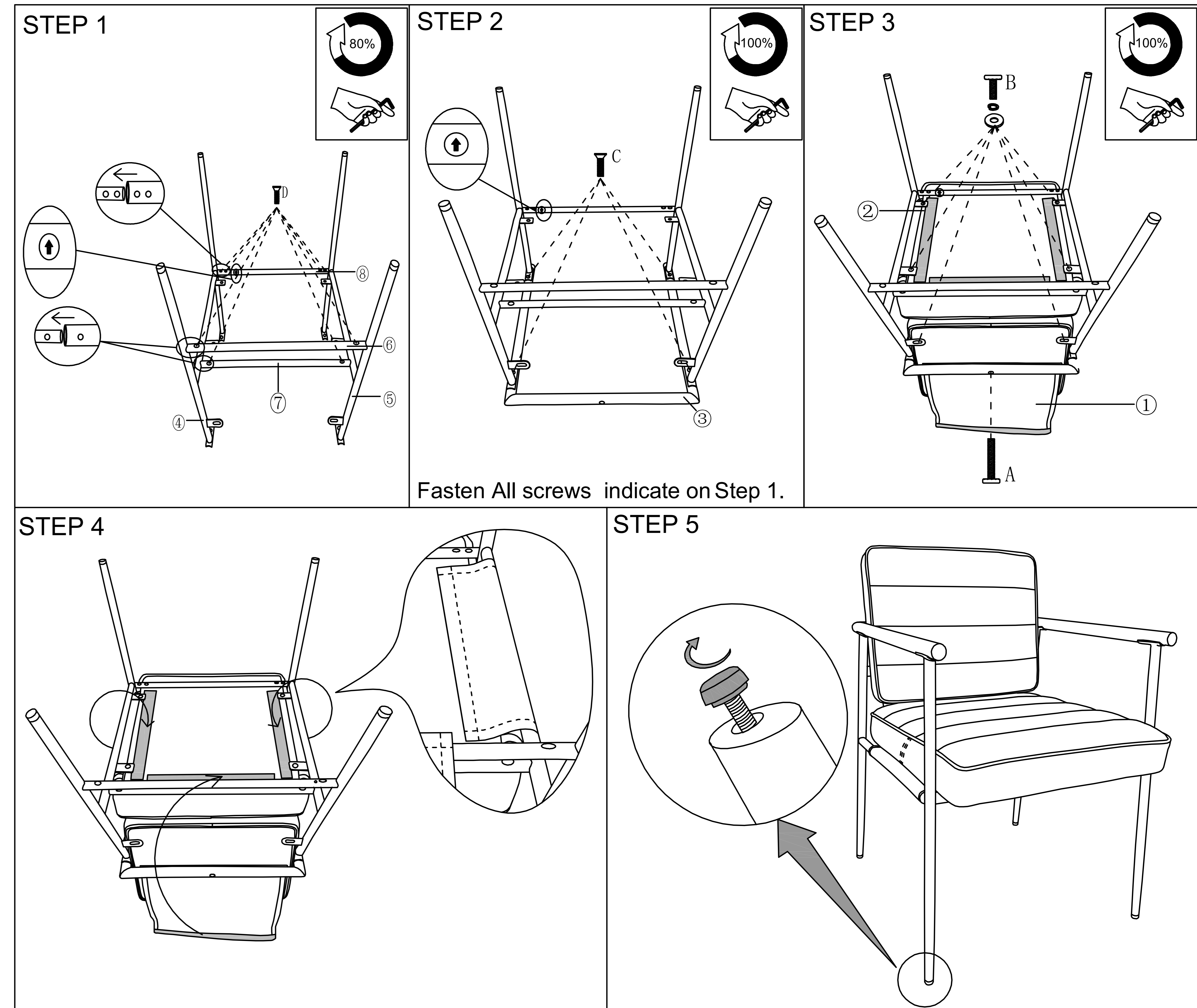

Manufactured in China for Dunelm (Soft Furnishings) Ltd. LE7 1AD & Dunelm (Soft Furnishings) Londonderry Ltd. BT48 8QN