

ASSEMBLY & PRODUCT CARE

DINING TABLE
5059413121951

Thank you for purchasing this product. Please read the instructions carefully before use to ensure safe and satisfactory operation of this product.

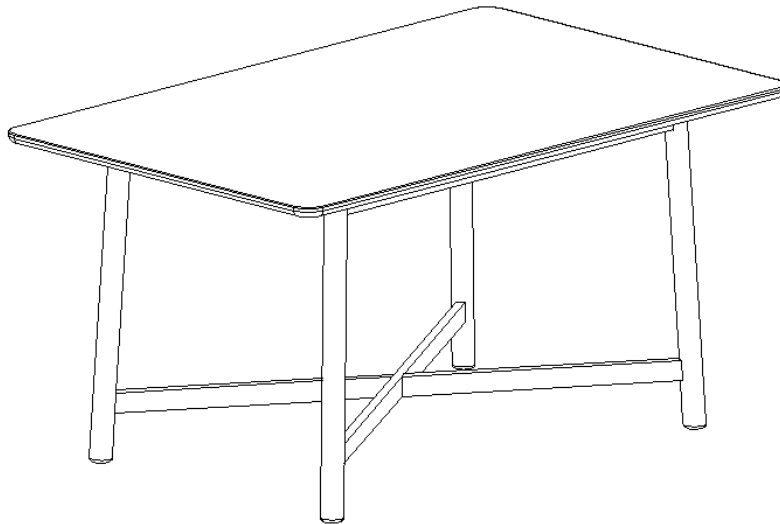

Pre-assembly preparation

Please ensure instructions are read in full before attempting to assemble this product

You will need



Screwdriver (not included)

Please check the pack contents before attempting to assemble this product. A full checklist of components is given in this leaflet. If any components are missing, please contact the retailer from whom you bought this product.





This product is **HEAVY**, it should be assembled as near as possible to the point of use. **TAKE CARE WHEN LIFTING** to avoid personal injury and (or) damage to the product.

This product takes approximately **10 MINUTES** to assemble with **2 PEOPLE**.





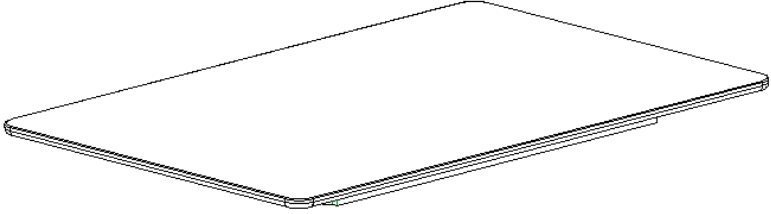

The fittings pack contains **SMALL ITEMS** which should be **KEPT AWAY FROM YOUNG CHILDREN**.

Read this leaflet in full before commencing assembly.

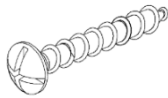
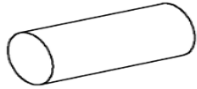
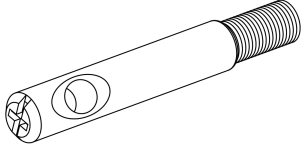
Parts checklist

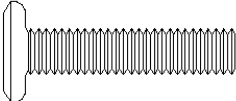
Part	Description	Qty
1	Rail 1 	1
2	Rail 2 	1
3	Top 	1
4	Leg 	4

Fittings checklist

Fixing	Description	Qty
A	Screws M4 x 30 	1
B	Wooden Dowel 10x30mm 	4
C	Connecting Bolt M8 	4
D	Cam Lock Nut 	4
E	Grub Screws 	4
F	Bolt M8x60 	8
G	Flat Washer M8/M19 	8
H	Lock Washer M8 	8
I	Allen Key 	1

Step by step assembly instructions

Step One

Insert Wooden dowels (B) and Connecting bolt (C) into pre-drilled hole on the leg.

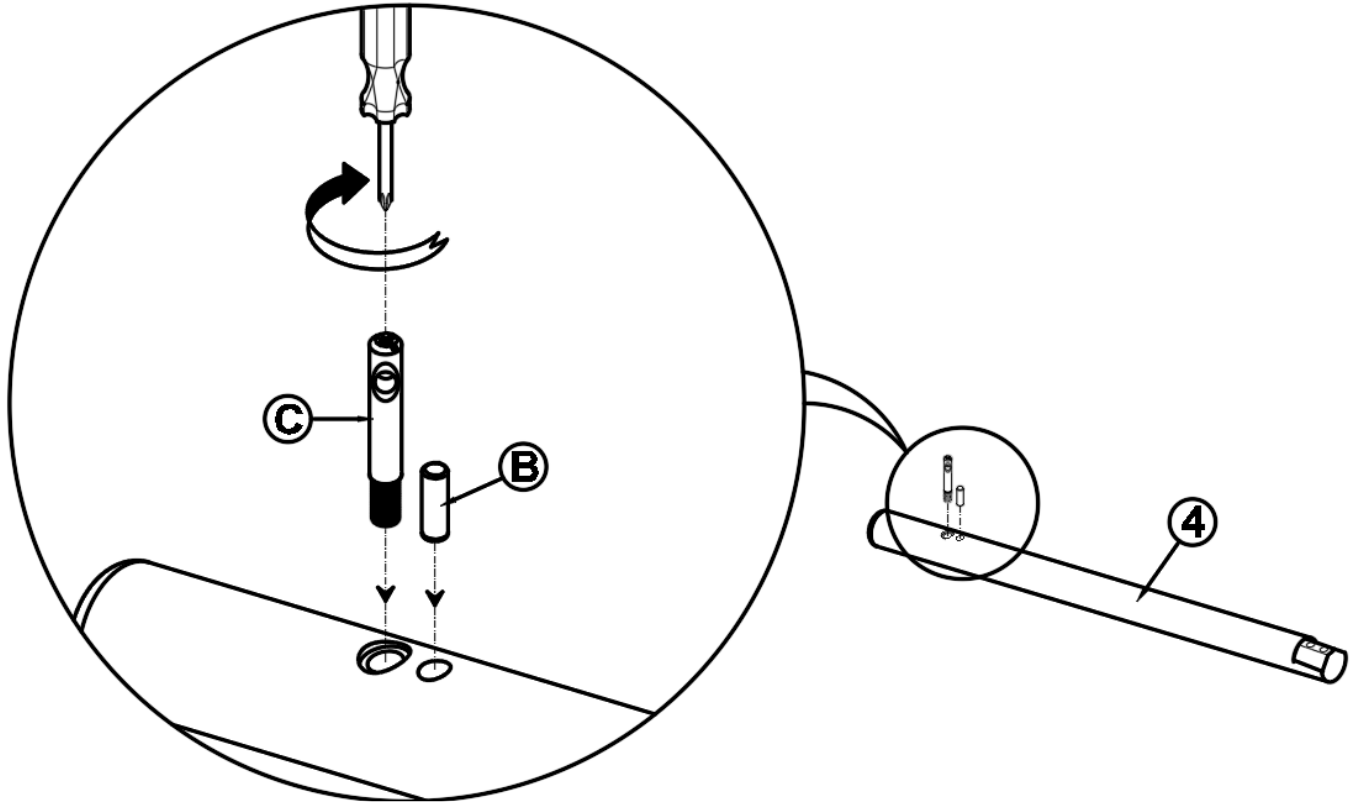

Step Two

Connect rail (1) to rail (2) by a screw (A).

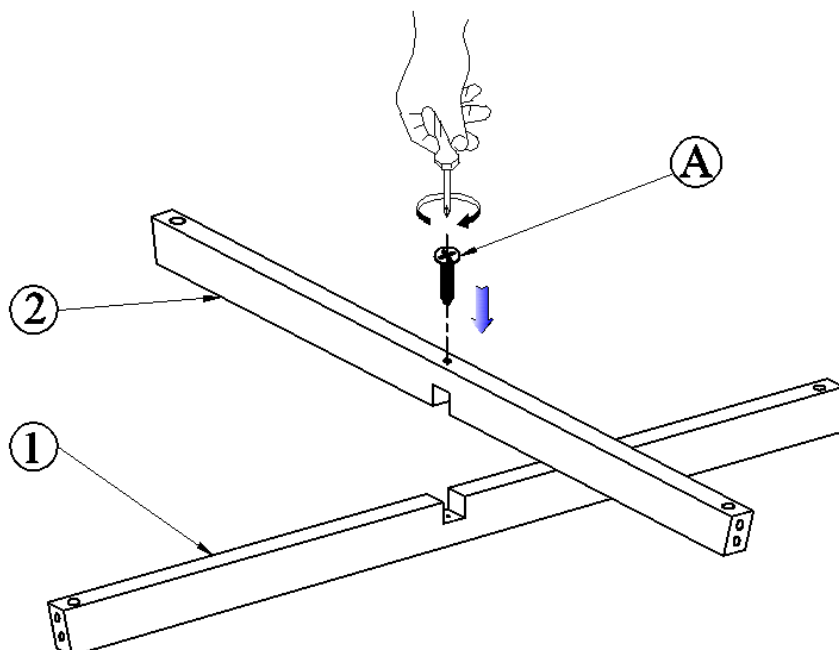

Step Three

Attach leg (4) onto the rail (1) & (2) using Grub screw (E) and Camlock nut (D) as show in figure.

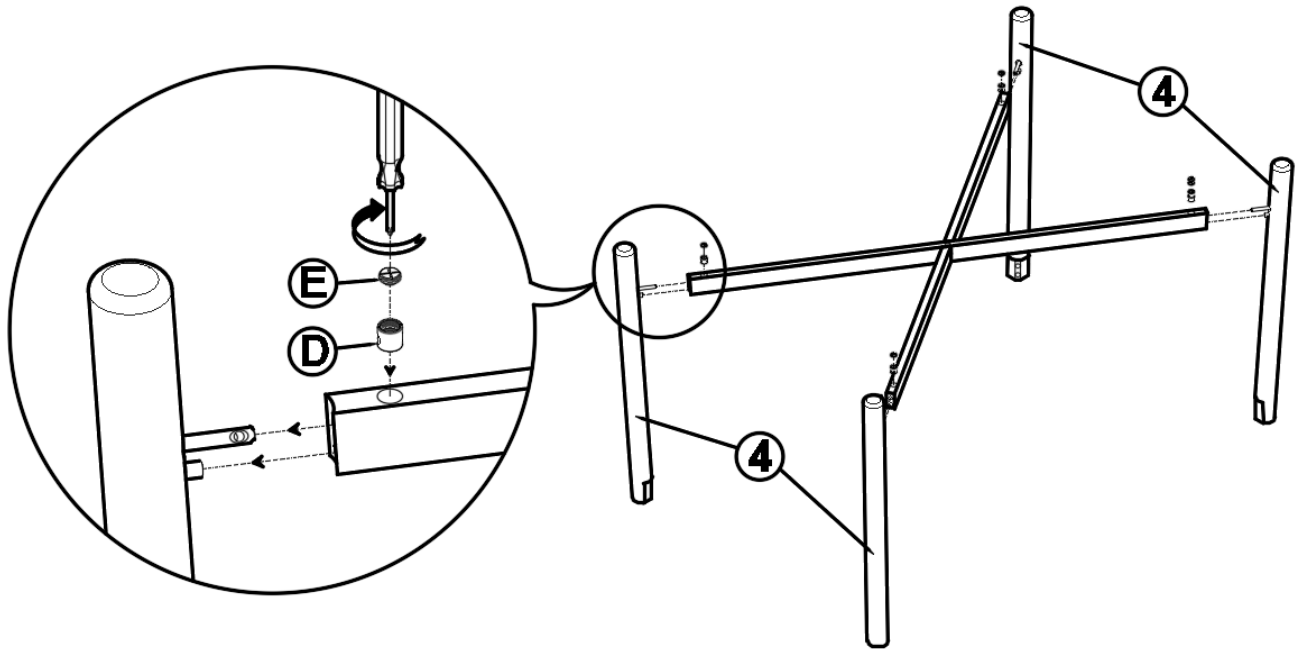

IMPORTANT: Hand tighten only to avoid damage to the legs.

Step Four

Attach leg frames at pre-drill hole on to table top (3) using using bolt (F), flat washer (G), lock wahser (H) and alen key (I) fight as shown in figure.

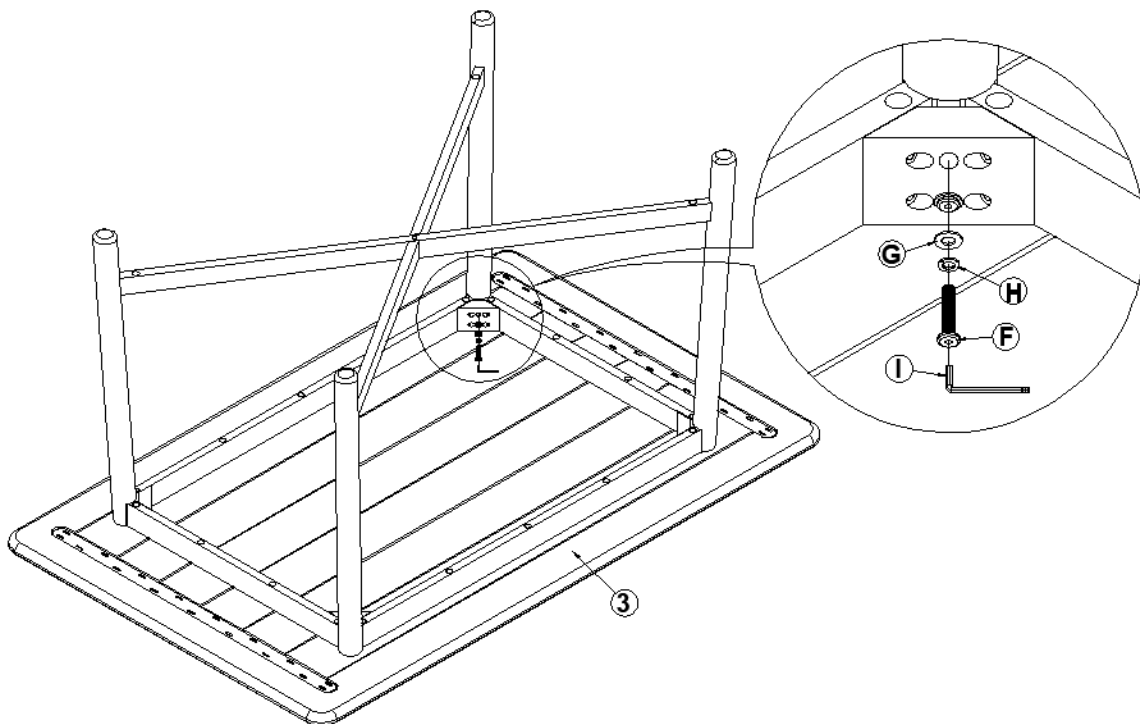

IMPORTANT: We would advise that at this stage the top remains inside the original packaging, or lay onto a clean carpet or banket to avoid damage to the surface.

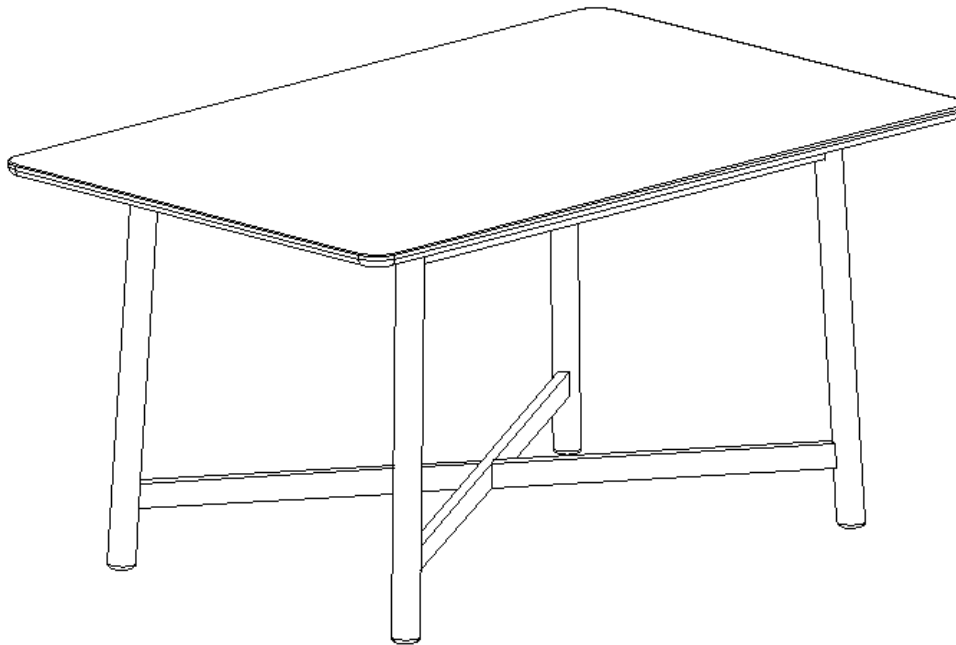
Finish.

IMPORTANT: PLEASE NOTE WHEN LIFTING OR MOVING THE TABLE ALWAYS DO SO FROM THE UNDER FRAME AND NOT THE TABLE TOP

Safety Instructions

Never drag furniture when moving it, always lift it.

When lifting or moving a table always do so from under frame and not the table top.

Periodically check all fixings to ensure none have come loose and re-tighten where necessary.

Please take care when handling or moving the furniture as careless handling may cause damage or injury.

Furniture can be dangerous if incorrectly installed. Assembly should be carried out by a competent person. No liability will be accepted for damage or injury caused by incorrectly installed or assembled furniture.

It is recommended that before moving heavy objects to a new location they are completely disassembled to avoid personal injury or damage to the furniture. Please be careful to retain all fittings when doing this.

Never overload an item such as a shelf that may be beyond what the shelf is reasonably expected to hold.

Please do not sit or place an amount of weight onto the edge of a tabletop as this may cause the table to topple.

IMPORTANT: If an Anti-topple device is included with this unit, you must install it in accordance with the instructions provided using fixings suitable for the wall type. If unsure, please seek advice of a professional.

Care and Maintenance

WHEN CARED FOR PROPERLY, THIS HAND CRAFTED FURNITURE WILL PROVIDE YOU WITH YEARS OF ENJOYMENT IN YOUR HOME.

How to care for Wood furniture (unpainted)

Never use sharp items on the surface of the product. For example knives and utensils may damage the product. It is also advisable to place a mat under paper when writing.

Furniture with a hard lacquer, wax polish or painted surface should be dusted with a dry cloth. Waxed furniture will need to be given a coat of beeswax a couple of times a year to help maintain its luster.

Spray polishes are best avoided as they contain silicones which may spoil the furniture's surface by building up over time.

Make sure all surfaces are protected from heat and liquids by mats and coasters. Wipe up spills immediately and ensure that a mat or pad is placed under paper if you are writing.

Extendable dining tables should be left extended for the first few months to avoid an uneven appearance. Likewise, lamps and ornaments should also be moved regularly.

Our furniture will endure most temperatures in the home but it is best to avoid placing furniture next to heat sources such as radiators or fires. Be particularly careful with solid wood as the lack of humidity caused by central heating can cause damage such as warping.

How to care for Painted Wood furniture

Never use sharp items on the surface of the product. For example knives and utensils may damage the product. It is also advisable to place a mat under paper when writing.

Hand painted brush stroke finish's will hold up to everyday wear and tear quite nicely. However, it is important to remember that your piece is still a wood piece of furniture and should be cared for as such.

Painted furniture still requires regular dusting with a damp cloth. When very soiled wash with a solution of mild, non-abrasive detergent and warm water. Wring a cloth nearly dry and work on a small section at a time, then rinse with clear water drying after..

Never leave water to settle on the surface as this will cause damage. Any liquid spilled onto the item should be cleaned up immediately using an absorbent cloth.

AVOID chemical cleaners or liquid furniture polish including direct contact with greasy substances.

As with all natural wood products, there will be some movement within the parts as the furniture acclimatises to its surroundings, you may see slight chipping and cracks where panels meet, this is a completely natural occurrence with ALL painted products using natural solid timbers.

Painted surfaces can be carefully touched up with matching paint.

There will be various brush lines, slubs, and little inconsistencies in the painted finish, this is all part of the relaxed handfinished look and feel of hand painted collections.

How to care for Glass furniture

Never use sharp items on the surface of the product. For example knives and utensils may damage the product. It is also advisable to place a mat under paper when writing.

If the product component is chipped or broken, please consult the manufacturer, retailer or agent with regard to obtaining a manufacturing specification and shape for replacement glass quoting the model number and batch number.

Do not use the glass as a chopping surface. Do not strike the glass with hard or pointed objects. Do not sit or stand on horizontal glass surfaces.

Do not place very hot or very cold items against or in close proximity to glass surface(s).

The surface should be protected with coasters, trivets or placemats.

All spills should be blotted up immediately. Do not wipe the spill or this may spread it. Clean the surface with a clean soft cloth (non-abrasive) and mild detergent or stone soap.

How to care for Marble furniture

Never use sharp items on the surface of the product. For example knives and utensils may damage the product. It is also advisable to place a mat under paper when writing.

The surface should be protected with coasters, trivets or placemats.

All spills should be blotted up immediately, do not wipe the spill as this may make it spread.

Clean the surface with a clean soft cloth (non-abrasive) and mild detergent or stone soap. Do not use cleaners containing acids.

How to care for Metal furniture

Never use sharp items on the surface of the product. For example knives and utensils may damage the product. It is also advisable to place a mat under paper when writing.

Metal furniture requires minimal maintenance:

Cleaning your metal furniture is very simple. Use a soft cotton cloth and clean with mild detergent or water, using a towel immediately dry the furniture afterwards.

Metal furniture is usually damaged due to rust, as a precaution a soft wax after cleaning will help seal it.

If it has a few spots of rust, you can treat it with rust remover, following the manufacturers guidelines. (some finishes are made to look like rust)

Smudges and smears can be removed from metal furniture by using a window cleaner and a paper towel.

Indoor metal furniture is not recommended for outdoor use.

How to care for "Outdoor" Metal Furniture

Never use sharp items on the surface of the product. For example knives and utensils may damage the product. It is also advisable to place a mat under paper when writing.

Metal Furniture designed for outdoor use will age naturally due to the additional elements found in an exterior environment.

It is quite normal for cast and wrought iron products to develop surface rust and this aged appearance of the metal is to be expected. The rust will not affect the integrity of the product but adds a rustic patina finish to the items. Most of our iron products are supplied to naturally age in this way.

Metal products will age quicker when in close vicinity to the coast due to the increase of salt in the atmosphere.

Steel and aluminum products will dull and corrode over time, again depending on placement and exposure to the elements.

Some planters and furniture will have distressing, antiquing or faux rust already applied and this is a unique feature to depict a pre aged appearance.

Be mindful when placing some products designed to rust as part of their feature as they could leave tarnishing when hung on a wall or placed on the ground.

Cleaning your metal furniture is very simple.

Metal furniture requires minimal maintenance:

Use a soft cotton cloth and clean with mild detergent or water.

Specific metal cleaning products are available from hardware stores.

Smudges and smears can be removed from metal furniture by using a window cleaner and a paper towel.

Indoor metal furniture is not recommended for outdoor use.

In harsh weather conditions it is advisable to cover metal furniture and ornaments or place under cover where possible.

WHEN CARED FOR PROPERLY, THIS HAND CRAFTED FURNITURE WILL PROVIDE YOU WITH YEARS OF ENJOYMENT IN YOUR HOME.

PLEASE KEEP THESE INSTRUCTIONS FOR FUTURE REFERENCE