

# 19MM & 28MM ASHTON EYELET BAY POLE KIT

## Fitting Instructions

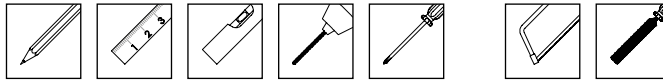



Please keep for future reference

### Tools required

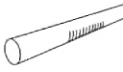
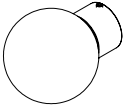
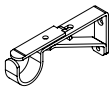
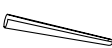

Please read these instructions carefully and check the contents of the pack before attempting to assemble and fit this product.

### Pack Contents

							
Pole Length	Serrated Bay Pole	Finial	Adjustable Bracket	Joiner Piece	Screws	Wall Plugs	Allen Key
400cm	2	2	5	1	10	10	1

Should any component be missing, please call the Customer Care Department on **01543 272605**

### Safety Recommendation

Always use a step ladder when working at heights.

DO NOT over reach. Always move the step ladder so that you are in a safe working position.

DO NOT hold or lean on the pole to support your weight.

We recommend you use two people for installation of larger poles.

Take care when using power tools, use of a Residual Current Device (RCD) is recommended.

Always use eye protection when drilling. Beware of hidden pipe runs and cables.

No liability will be accepted for damage or injury caused by incorrectly installed or assembled product.

PLEASE KEEP OUT OF THE REACH OF YOUNG CHILDREN. SMALL PARTS - CHOKING HAZARD  
PLEASE KEEP THESE INSTRUCTIONS AND THE BATCH CODE ON THE PACKAGING FOR FUTURE  
REFERENCE IN CASE OF ANY QUERIES

## Bracket & Pole Cut Positions

See diagram which matches your bay window style. Please note the distance from each pole end to the centre of the cuts. Orientate your pole to suit your bay. All measurements are approximate. Final position is a guide only.

Total pole length (when two poles are joined)

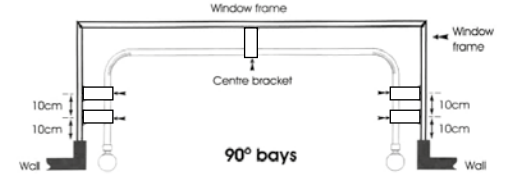
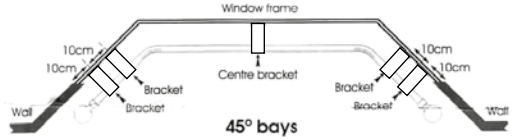
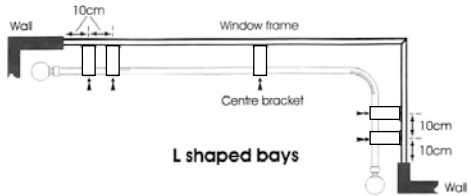
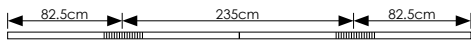

## Hanging Brackets

1. Remove part 'A' from the bracket – do not lose this as you will need later on in the installation. (note: you may find that part 'C' detaches, this can be reattached later too). (Fig. 1)
2. Using part 'B' and the two mounting holes, mark the bracket positions ensuring they are level. Drill and fix using fixings suitable for your wall type. (Fig. 2)

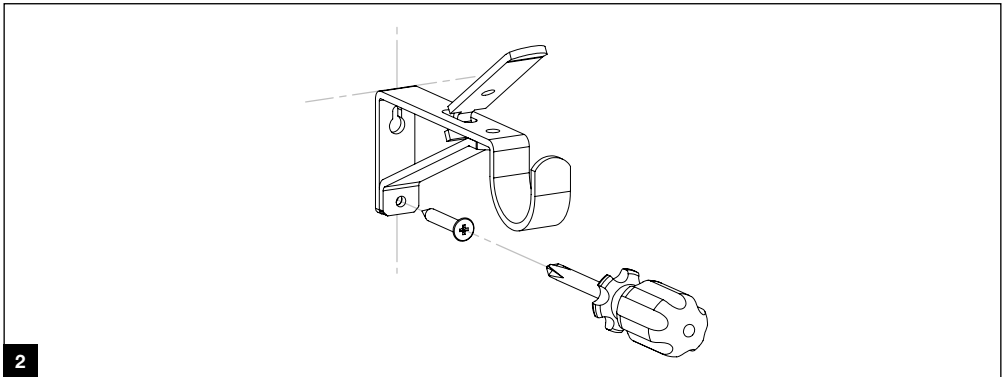
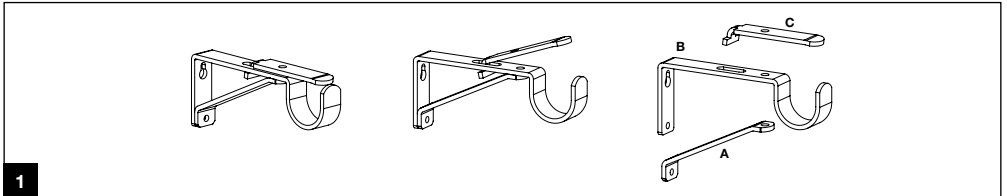

## Bending the bay pole

1. **Before you begin to bend the pole here's a practical tip -**  
Use your knee to ease the bending process to create a smooth bend. Gently apply pressure throughout the length of the bend. Please ensure there is adequate padding on your knee when bending the pole and be careful to not cause any strain or injury.
2. Working from the centre position of the bend, bend the pole slightly in the arrow positions shown in the diagram until you reach your required angle checking the fit as you go along. (Fig. 3)
3. Be careful to avoid injury or damage to your clothes as the pole bends and cut segments close.

Ensure the cuts are to the inside of the bend.

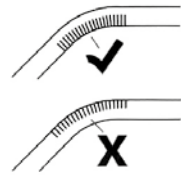

Bend the pole in the direction of the slots.

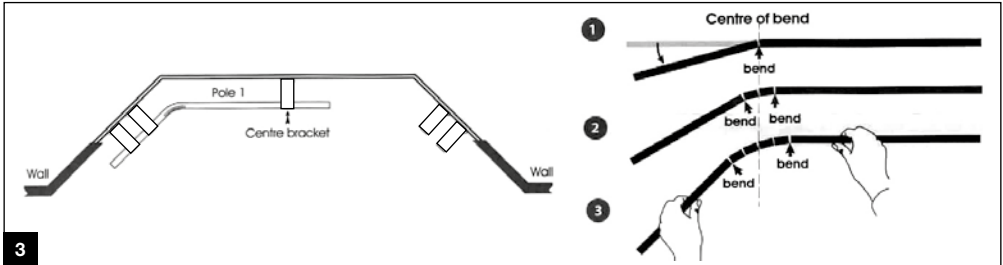

## Trimming the bay pole to size

1. Using the middle of the centre bracket as your measure, mark and trim each pole to length. (Fig. 4A)
2. Leave a minimum of 10cm after the last bracket for the eyelet curtain and the fix of the pole finial. (Fig. 4B)

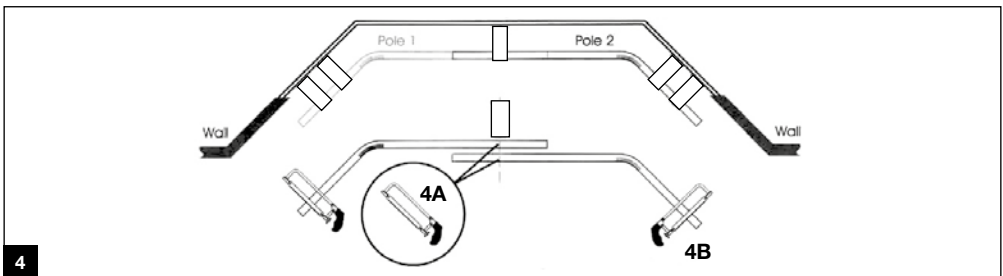

## Hanging the eyelet curtain

1. Slide the eyelet curtain onto the pole length. Leave 4 or 6 eyelets (if you want two pleats after the last bracket) from the curtain end.
2. Lift up part 'C' of the bracket and place the pole into the bracket. (Fig. 5)
3. Loop the curtain around in front of the bracket and slide on the next eyelet. (Fig. 6)
4. Place a second eyelet on the pole and slide on another bracket front section. (Fig. 7)
5. Loop the curtain around the bracket front again and create your remaining eyelet pleats. Slide on the finial and secure with grub screw and allen key. (Fig. 8)

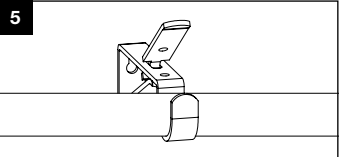

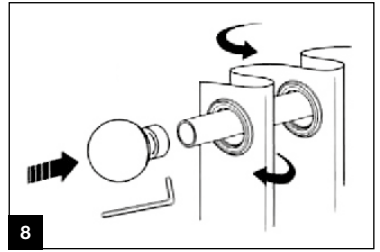
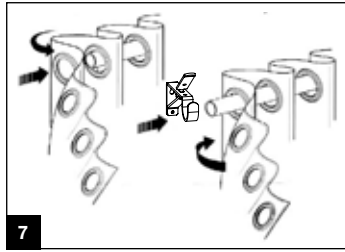
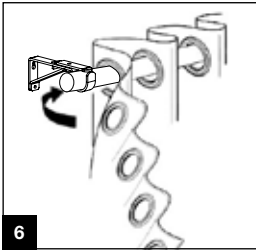

## Hanging the bay pole

1. Slide the centre bracket front a little way up the first pole. Insert the joining piece halfway into the first pole. Slide the second pole over the insert to make the join. (Fig. 9)
2. Place the centre bracket to cover the pole join. (Fig. 10)
3. To secure the bay pole into position, move the bracket part 'C' back into position and tighten with the screw. Repeat for all five brackets. (Fig. 11)

This pole can be used with curtain header tape with the addition of curtain rings. Curtain rings are available to purchase separately from Dunelm.

