

Delphi Wide TV Unit

INSTRUCTIONS

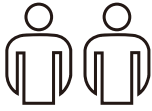

60 MINS



2 PEOPLE ASSEMBLY



MEDIUM DIFFICULTY

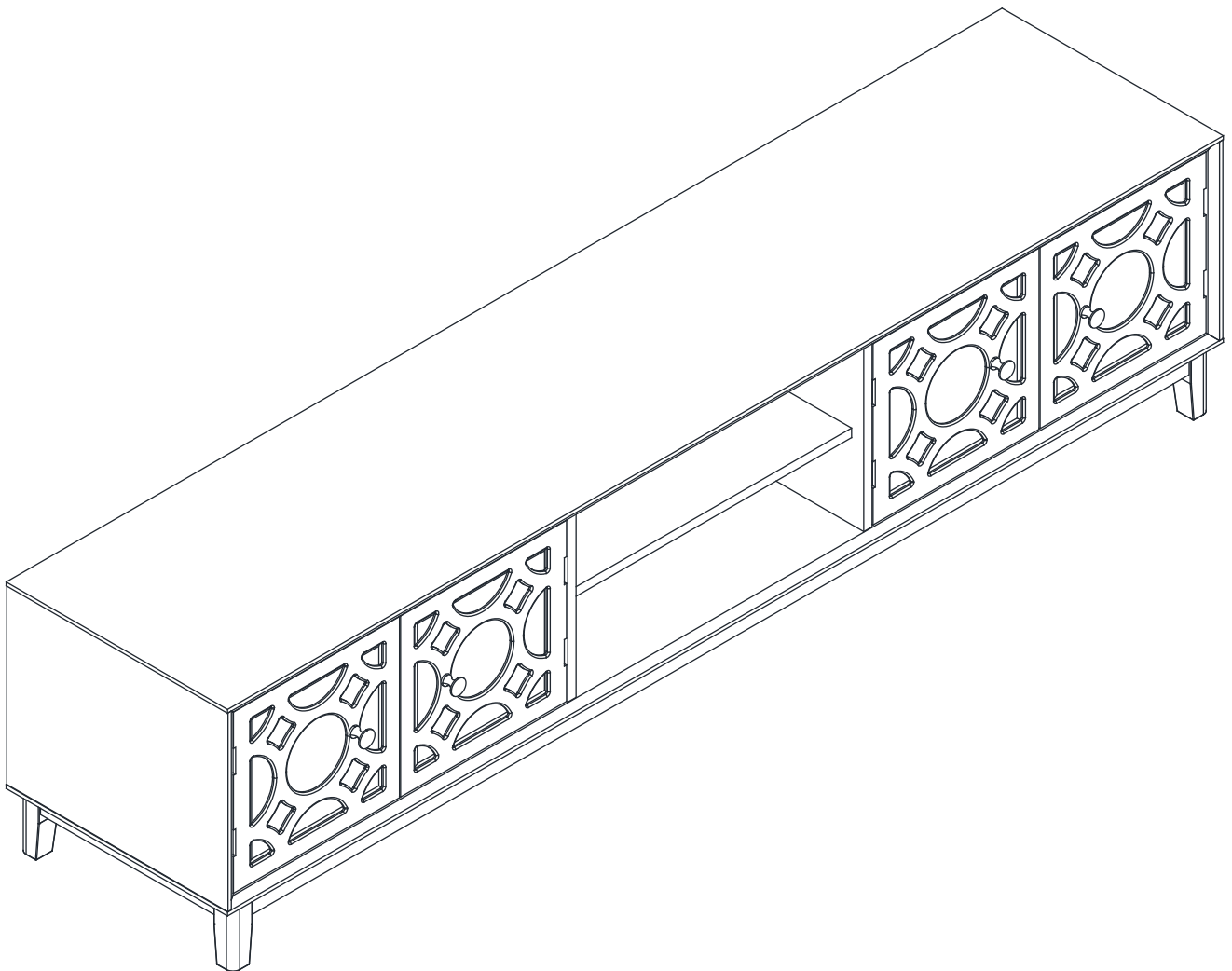

Dunelm

www.dunelm.com

Thank you

Dear Customer

Thank you for purchasing your new piece of furniture from Dunelm. We put a lot of effort in the design and construction of our products to ensure they set the standard for quality, durability and ease of assembly.

If for any reason you feel we haven't lived up to the high standards we set ourselves, please don't hesitate in contacting us on **03451 656565** where our team will be very keen to understand what has gone wrong and, more importantly, put it right.

The next step...

There is no need to feel daunted by the number of parts and fittings in front of you, we have compiled this straight forward, step-by-step guide to make sure that assembling your furniture is as easy as 1, 2, 3,4. Before you begin, we advise that you check that you have everything you need to get started.

Top tip

Find a space to spread everything out across the floor before you begin assembling the item. Lay each panel down on a clean and level area, ideally in the room of intended use, ensuring there is enough room to manoeuvre around the item. It is recommended that two people assemble this product together. The full list of furniture parts, fixtures and fittings, as well as the tools you will need for assembly can be found on page 2 and 3 of this manual.

Top tip

Identify all of the fittings, make sure that you have them all prepared and familiarise yourself with each component, to make things easier when you are putting it all together.

Safety and care advice

IMPORTANT - The first step you need to take is to ensure your safety! Please take the time to read and understand these instructions before assembling your furniture.

Please keep these instructions for future reference.

Keep children and animals away from the assembly area. This furniture contains small parts that could cause choking if swallowed.

Keep all plastic wrapping materials away from babies and children to avoid danger of suffocation.

Ensure that all packaging is disposed of carefully and responsibly.

From time to time check that there are no loose fittings on the unit, re-tighten when necessary.



Two people may be required for the assembly of this product.

Once items are part or fully assembled they are not returnable unless faulty.





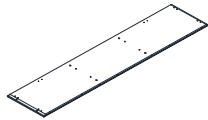
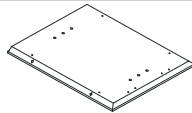
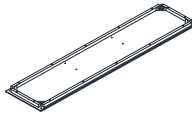
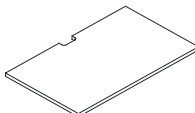
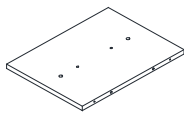
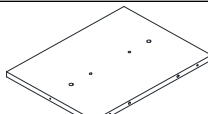
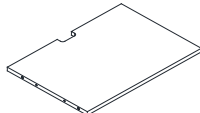
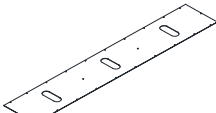
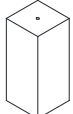
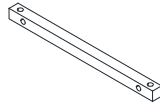

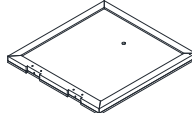
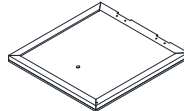



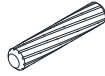
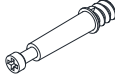

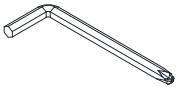

This item is not for outdoor use – unless stated otherwise.

Some items will be supplied with a wall fixing strap, which we recommend is used to secure the item to the wall, to prevent a child from accidentally pulling furniture over. Furniture can be dangerous if incorrectly installed. Assembly should be carried out by a competent person. No liability will be accepted for damage or injury caused by incorrectly installed or assembled furniture.

Component parts supplied



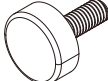

Ref	Dimensions	Visual	Qty
1	1800 x 400mm		1
2	400 x 312mm		2
3	1800 x 400mm		1
4	601 x 365mm		2
5	387 x 288mm		1
6	387 x 288mm		1
7	520 x 365mm		1
8	1785 x 311mm		1
9	102 x 45mm		2
10	318 x 20mm		4
11	103 x 35mm		4
12	300 x 284mm		2
13	300 x 284mm		2

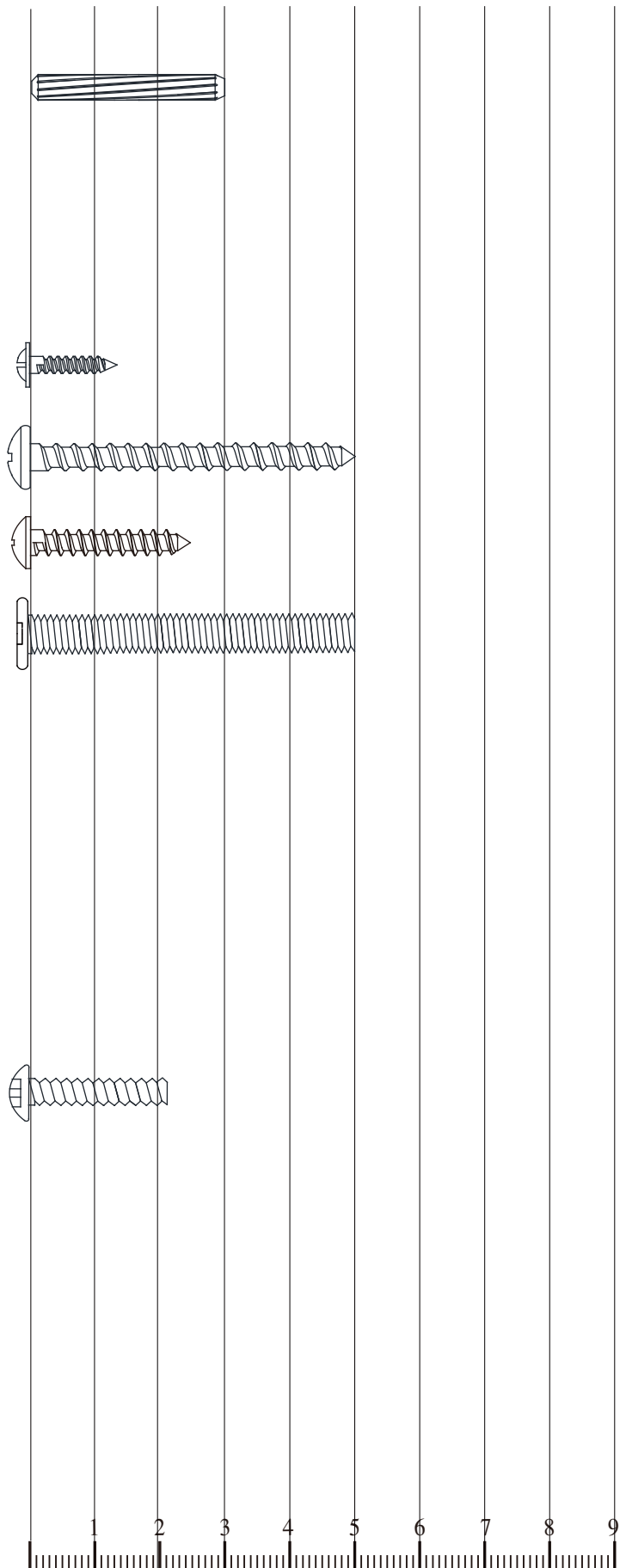
Parts and fittings

Ref	Dimensions	Visual	Qty
A	5.8x30mm		28
B			8
C			8
D	3x14mm		24
E	4x50mm		10
F	4x24mm		16
G	8x50mm		4
H			1
I			4
J			4
K			4
L	4x22mm		4
M			4
N			12
O			6
P			8
Q			4

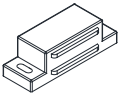

Parts and fittings

Ref	Dimensions	Visual	Qty
R			2
S	3x16mm		4
T	3x12mm		4
U	3.5x14mm		40
V			8

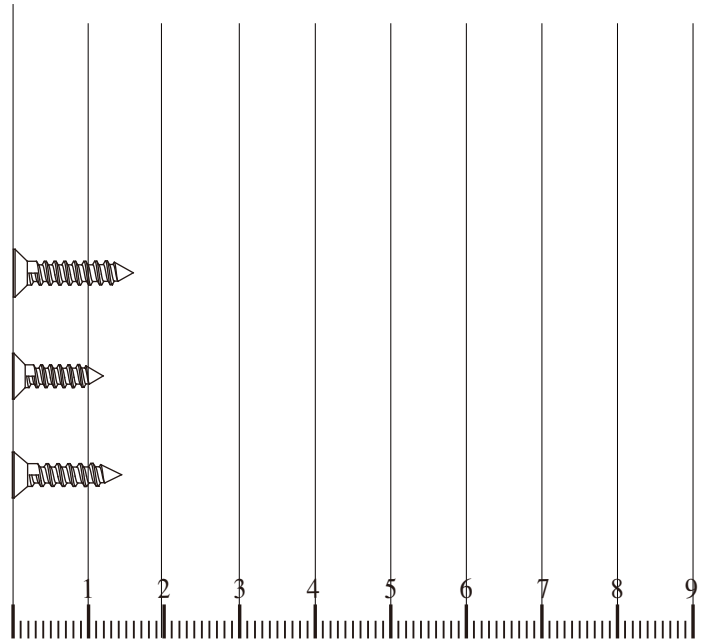

Exploded view

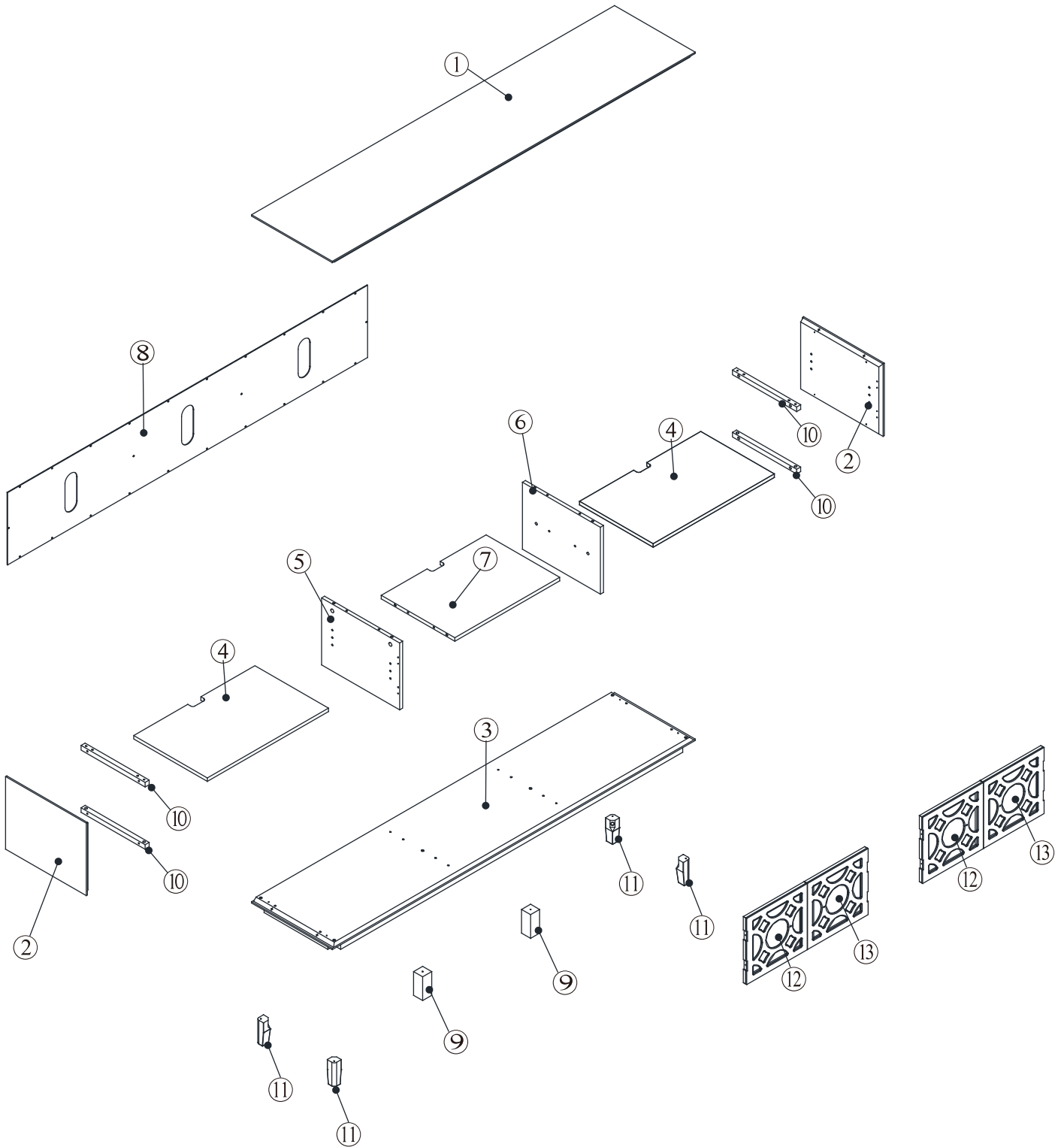

Step 1:

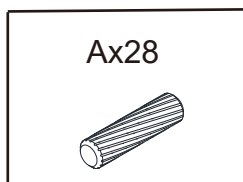
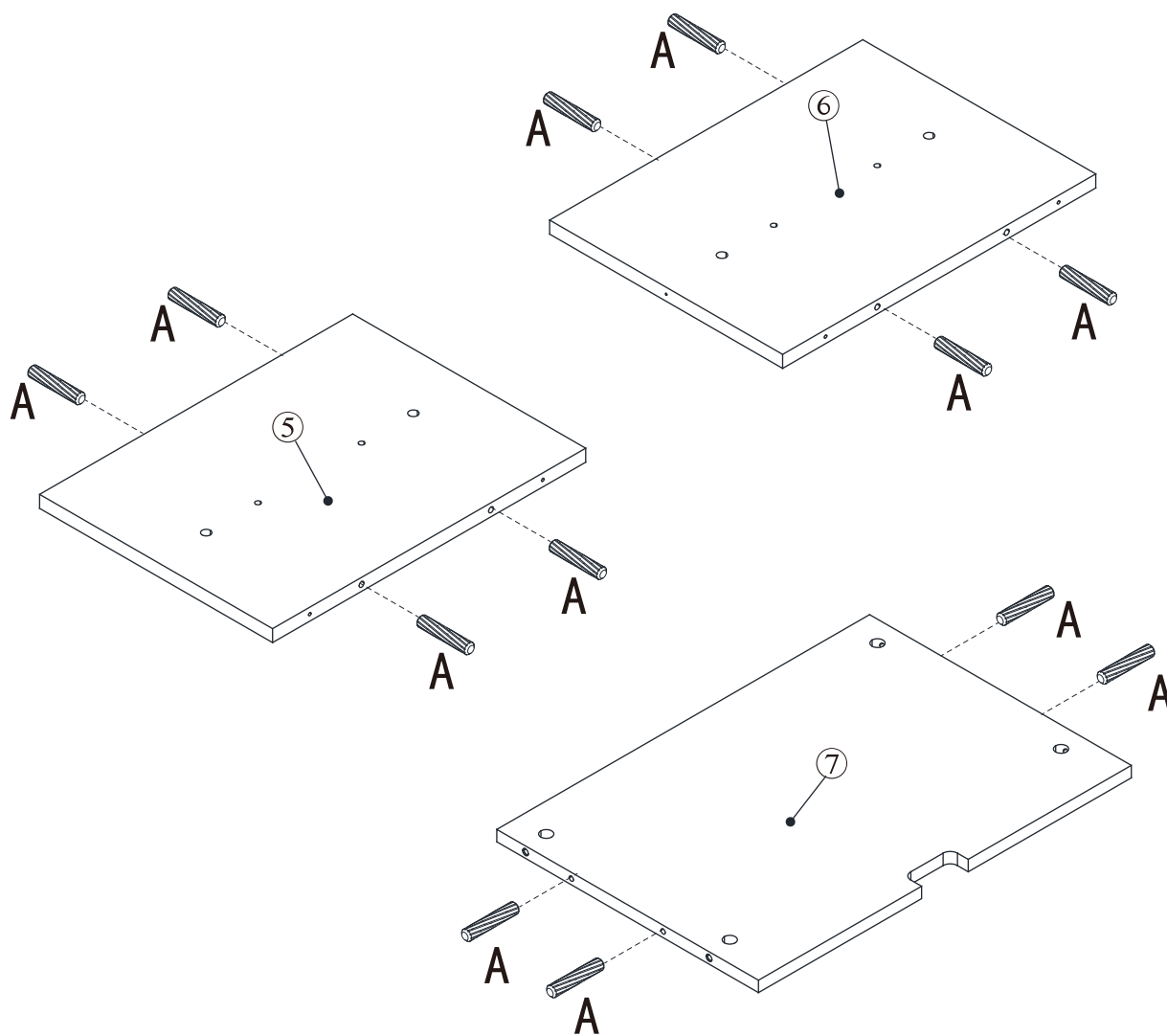
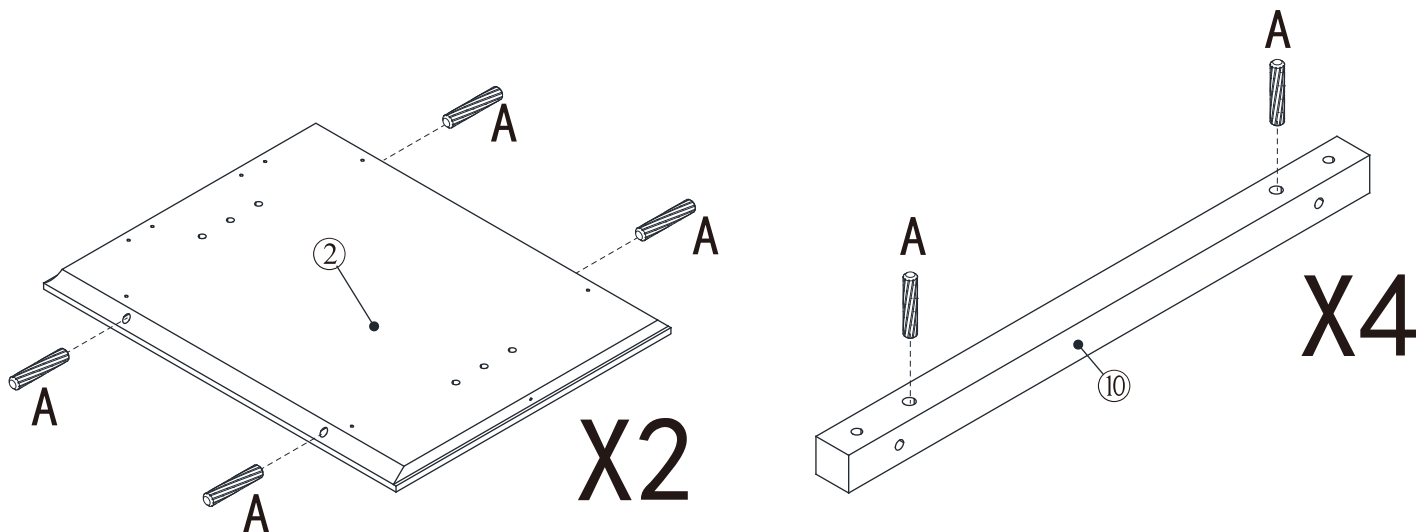

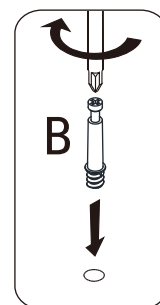
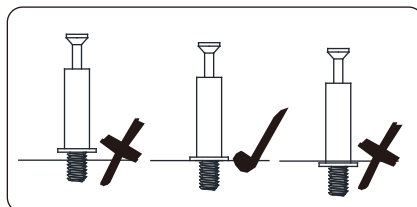
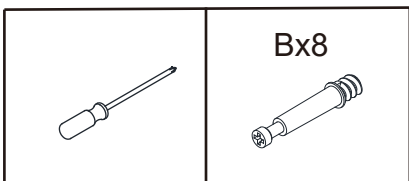
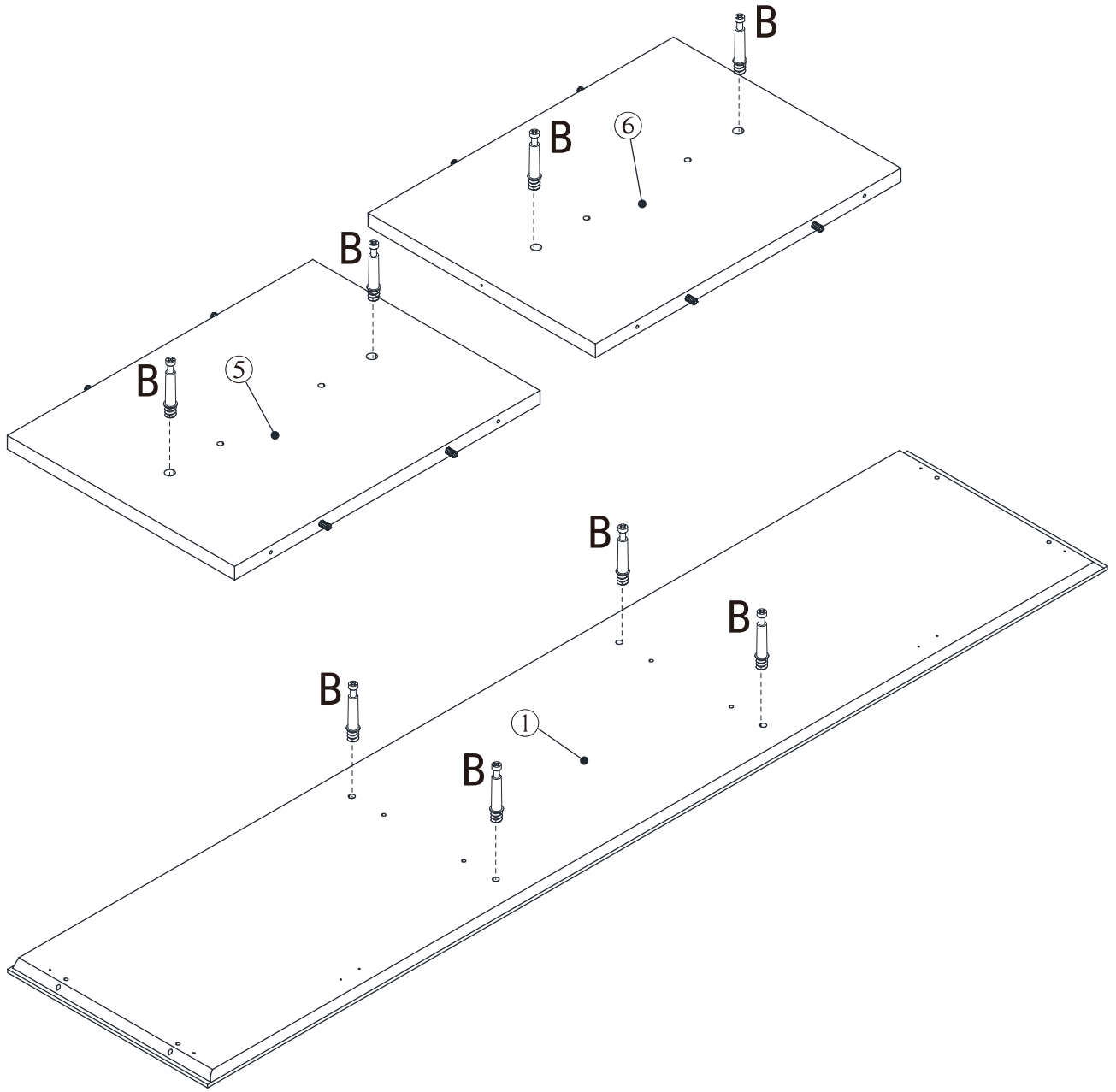

Step2:

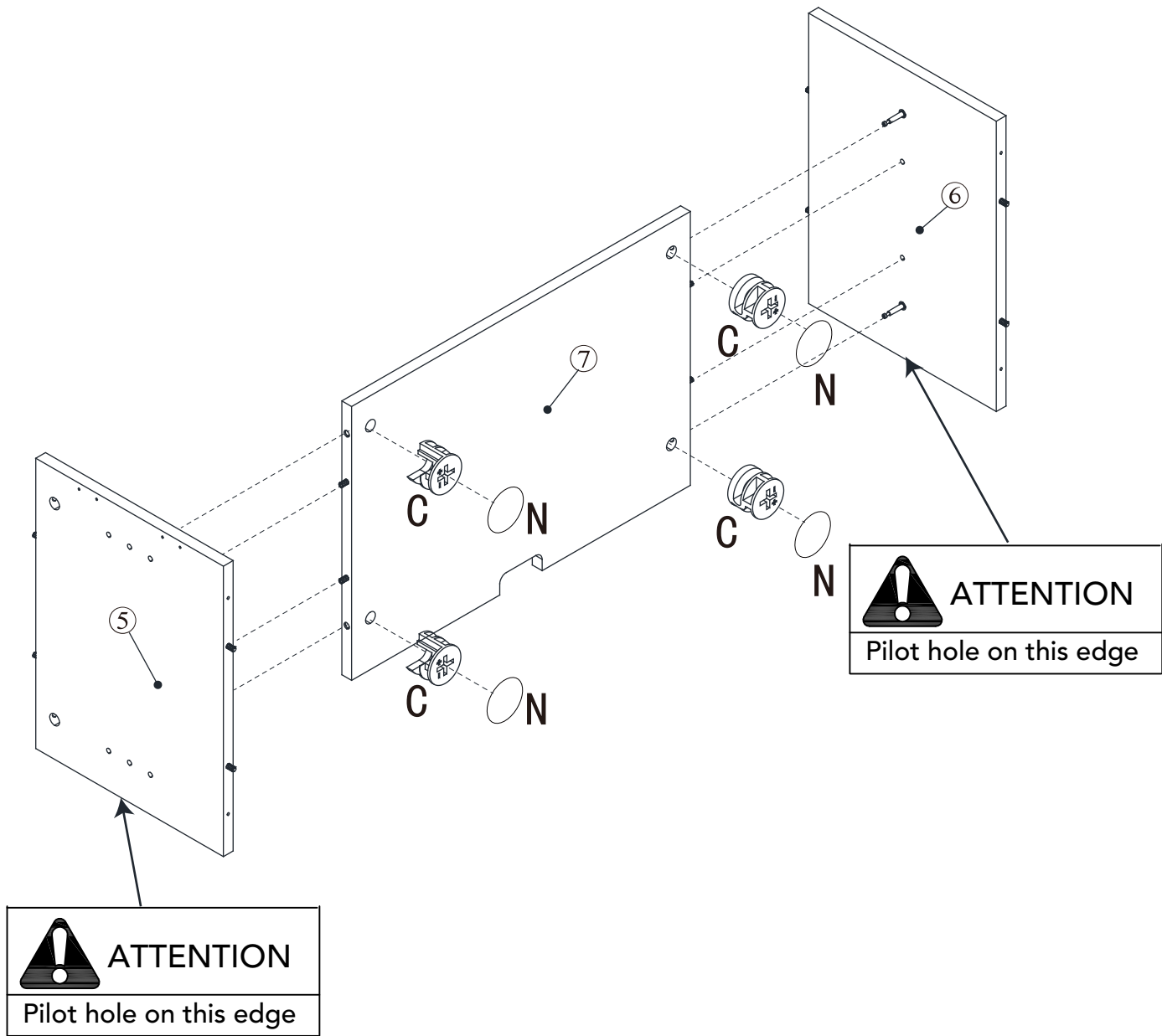

Step3:

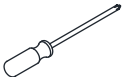



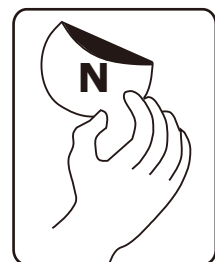
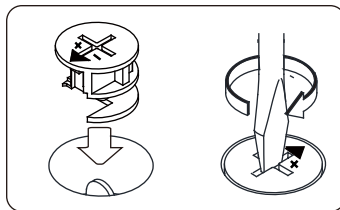

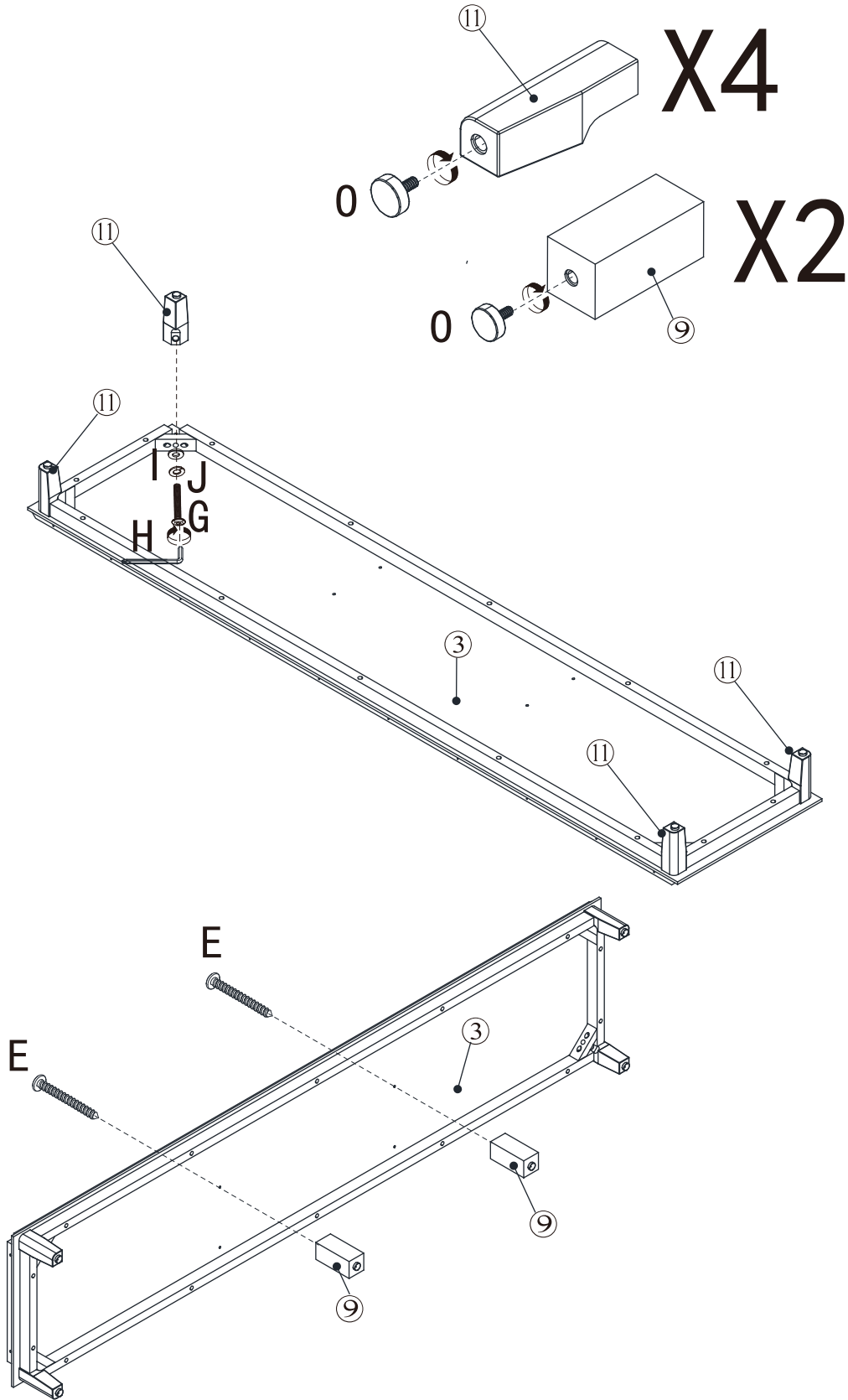

	Cx4 	Nx4 
--	---	---

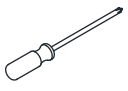

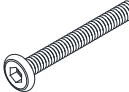
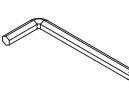



Step4:

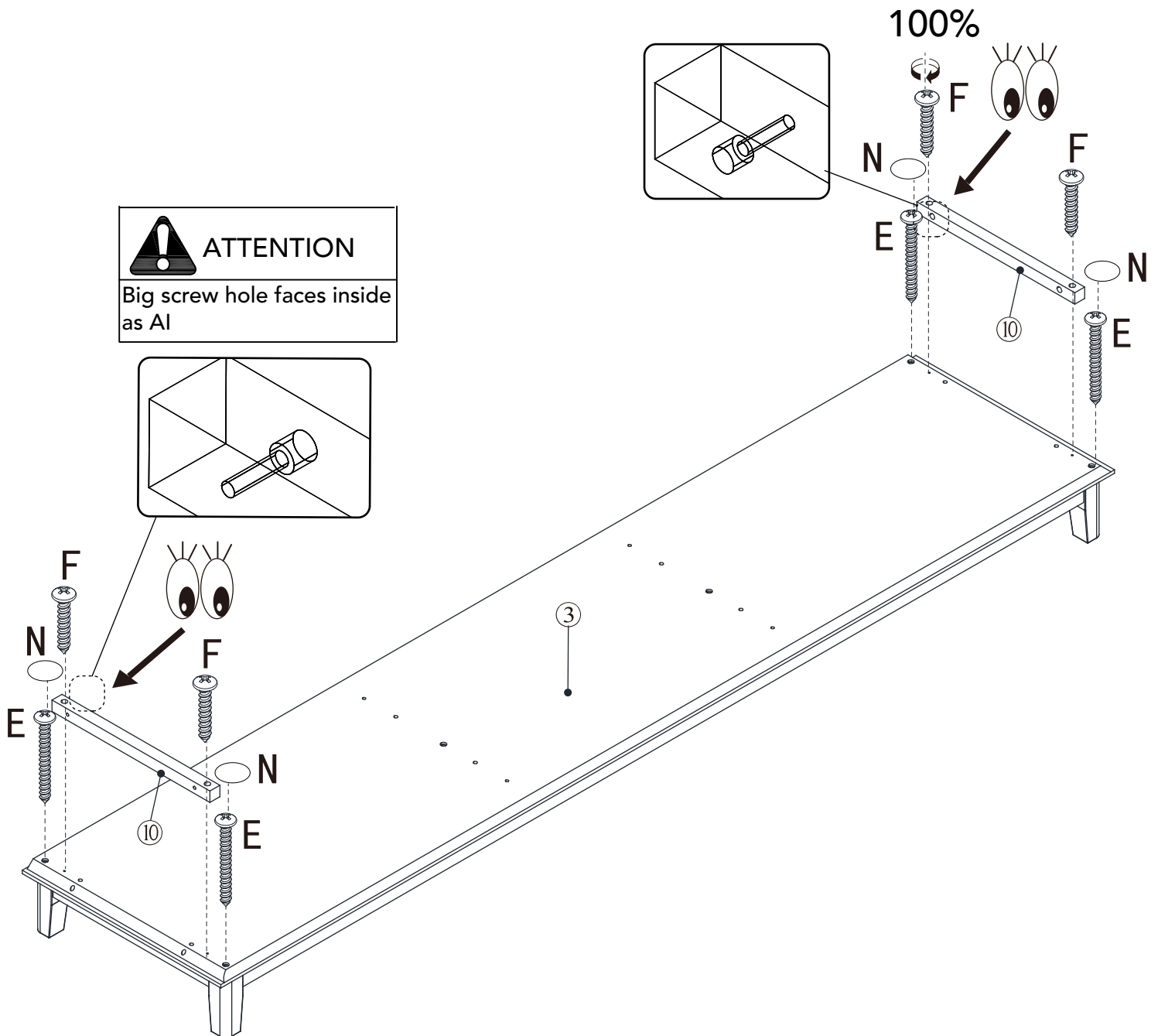

	Ex2	Gx4	Hx1	Ix4	Jx4	Ox6
						

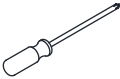
Step5:



	Ex4 	Fx4 	Nx4 
---	--	--	--

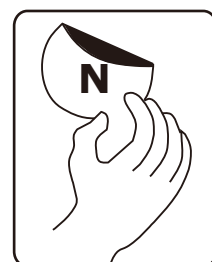

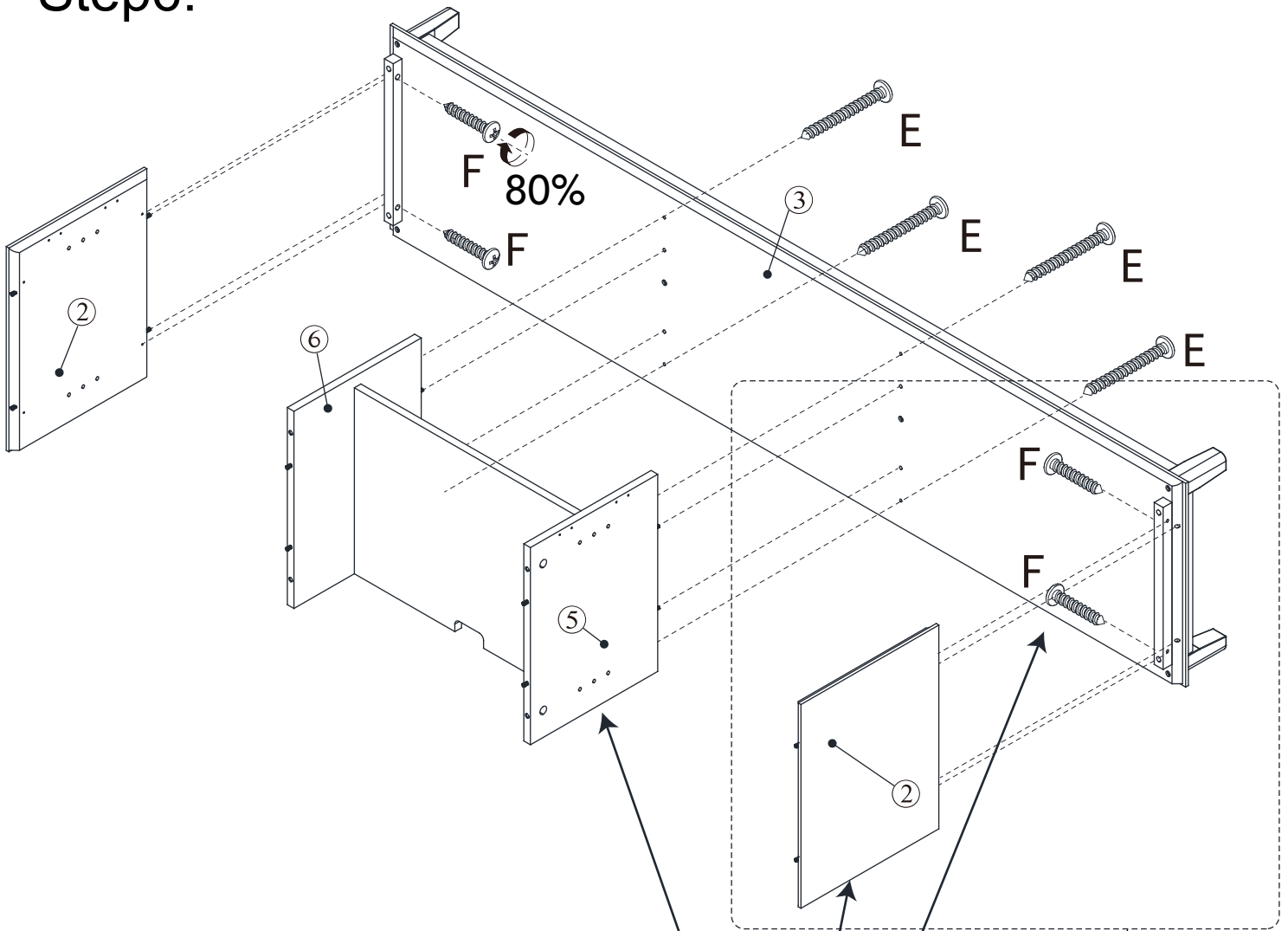

Step6:

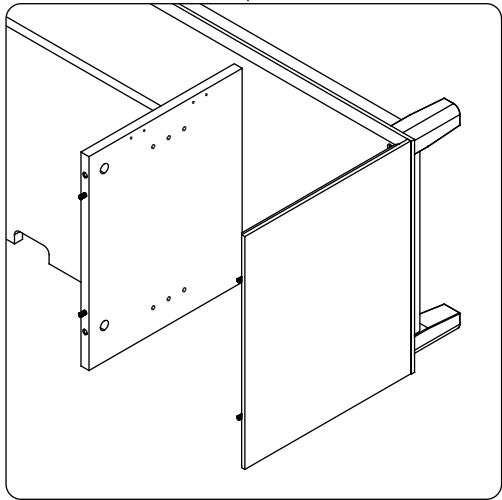

 **ATTENTION**
Pilot hole on this edge

 **ATTENTION**
Pls make sure the side and the top/bottom joint align then tighten all the screws

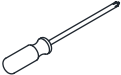



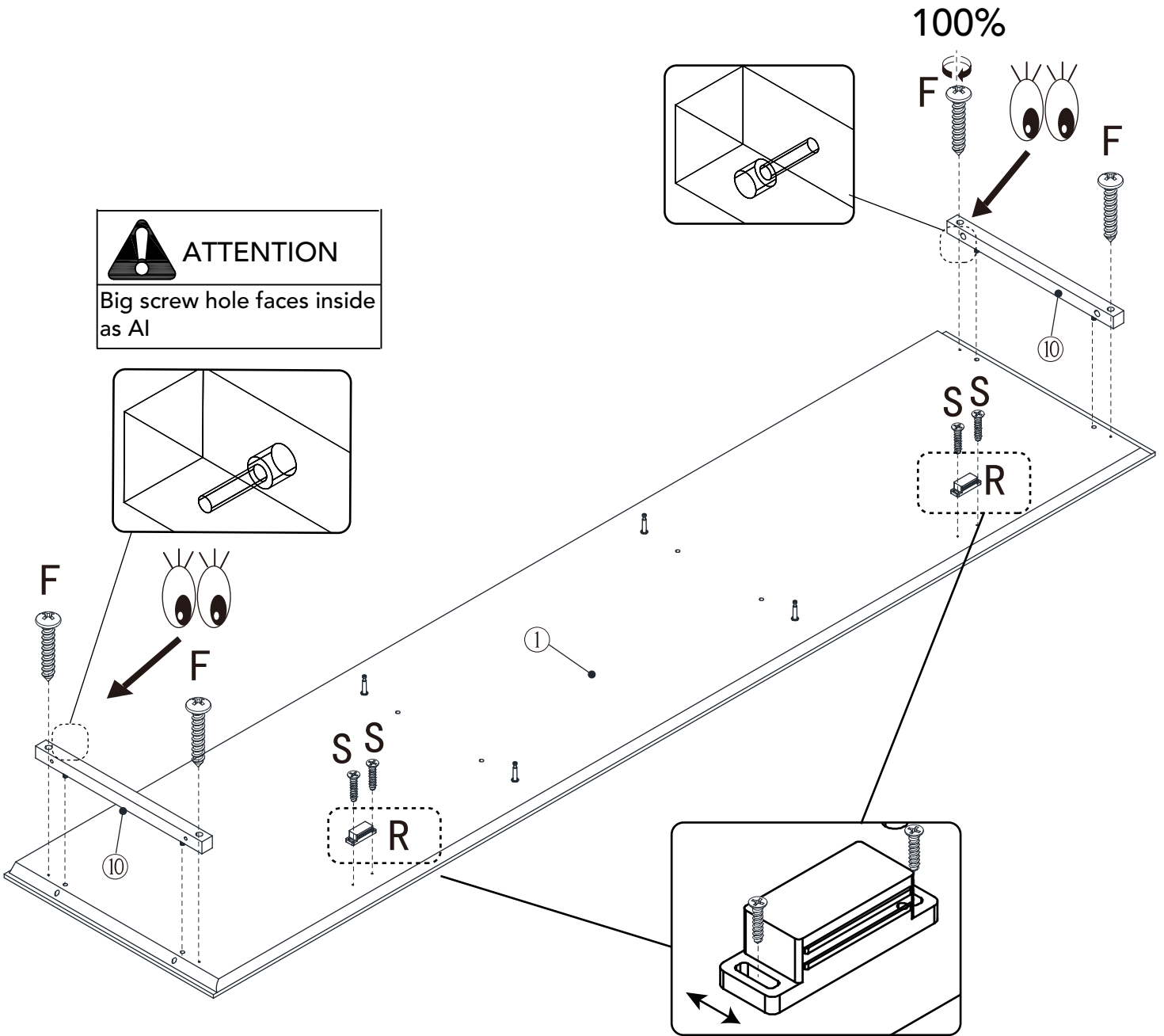

	Ex4	Fx4
		

Step 7:

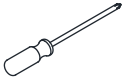
ATTENTION
Big screw hole faces inside as AI

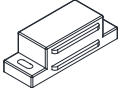



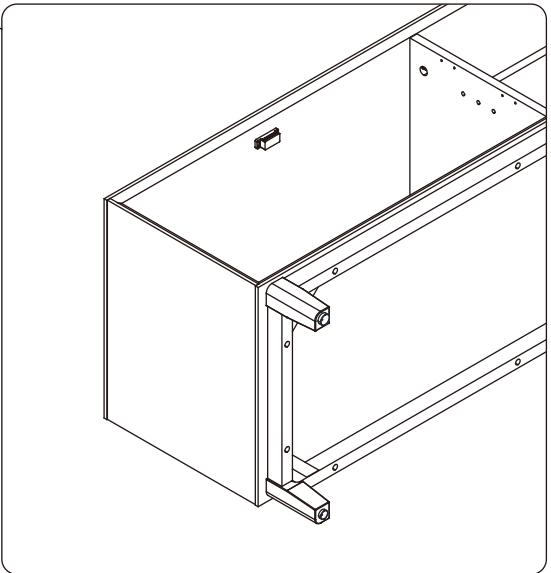
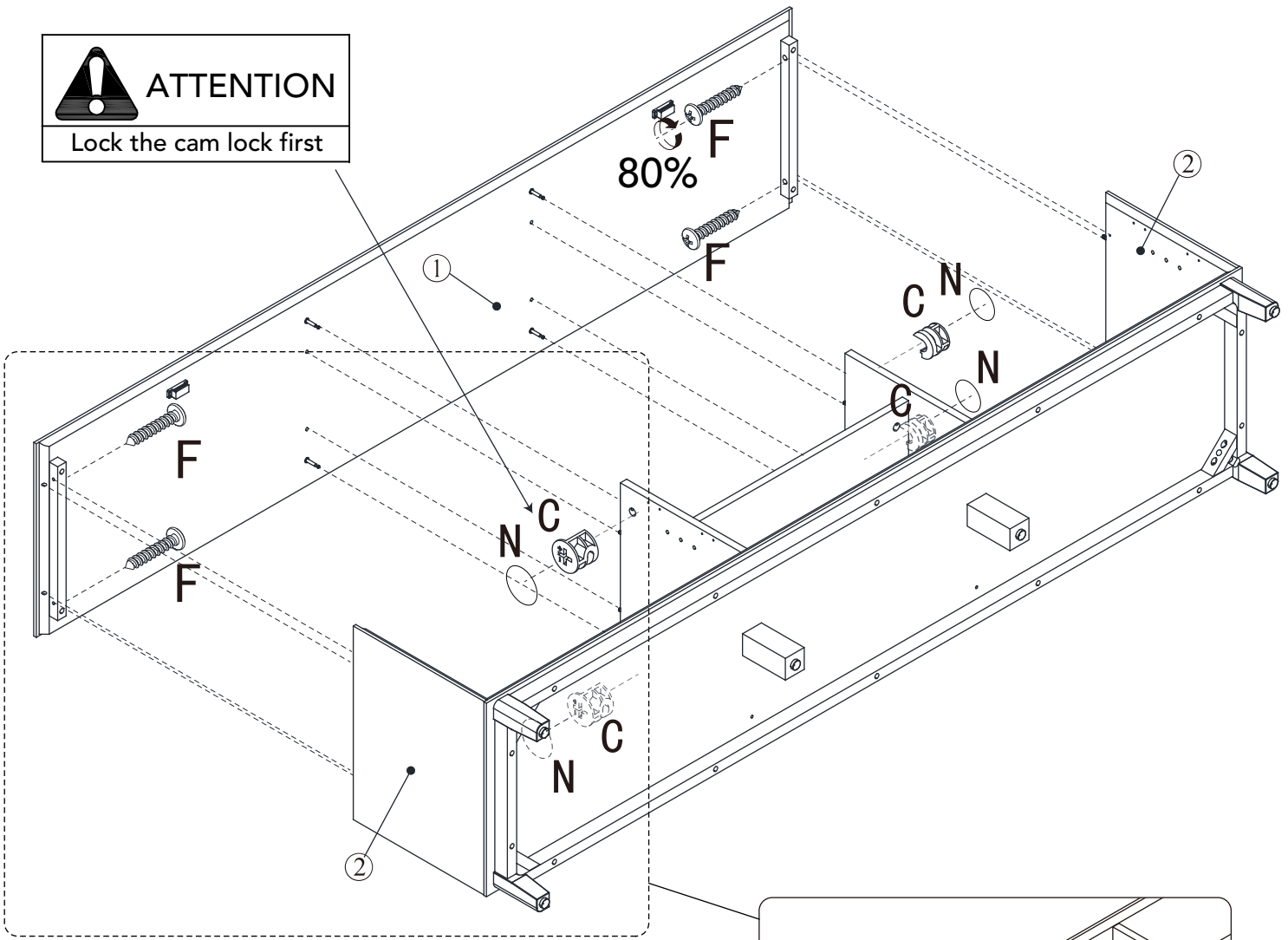

	Fx4 	Rx2 	Sx4 
---	--	--	--

Step8:

ATTENTION
Lock the cam lock first

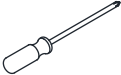

ATTENTION
Pls make sure the side and the top/bottom joint align then tighten all the screws

	Cx4 	Fx4 	Nx4 
---	--	--	--

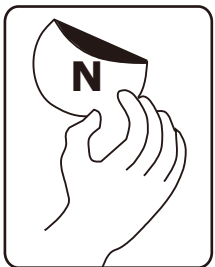
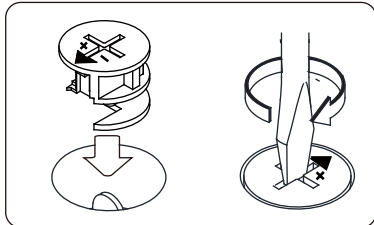

Step9:

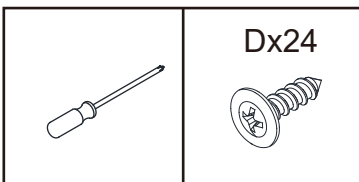
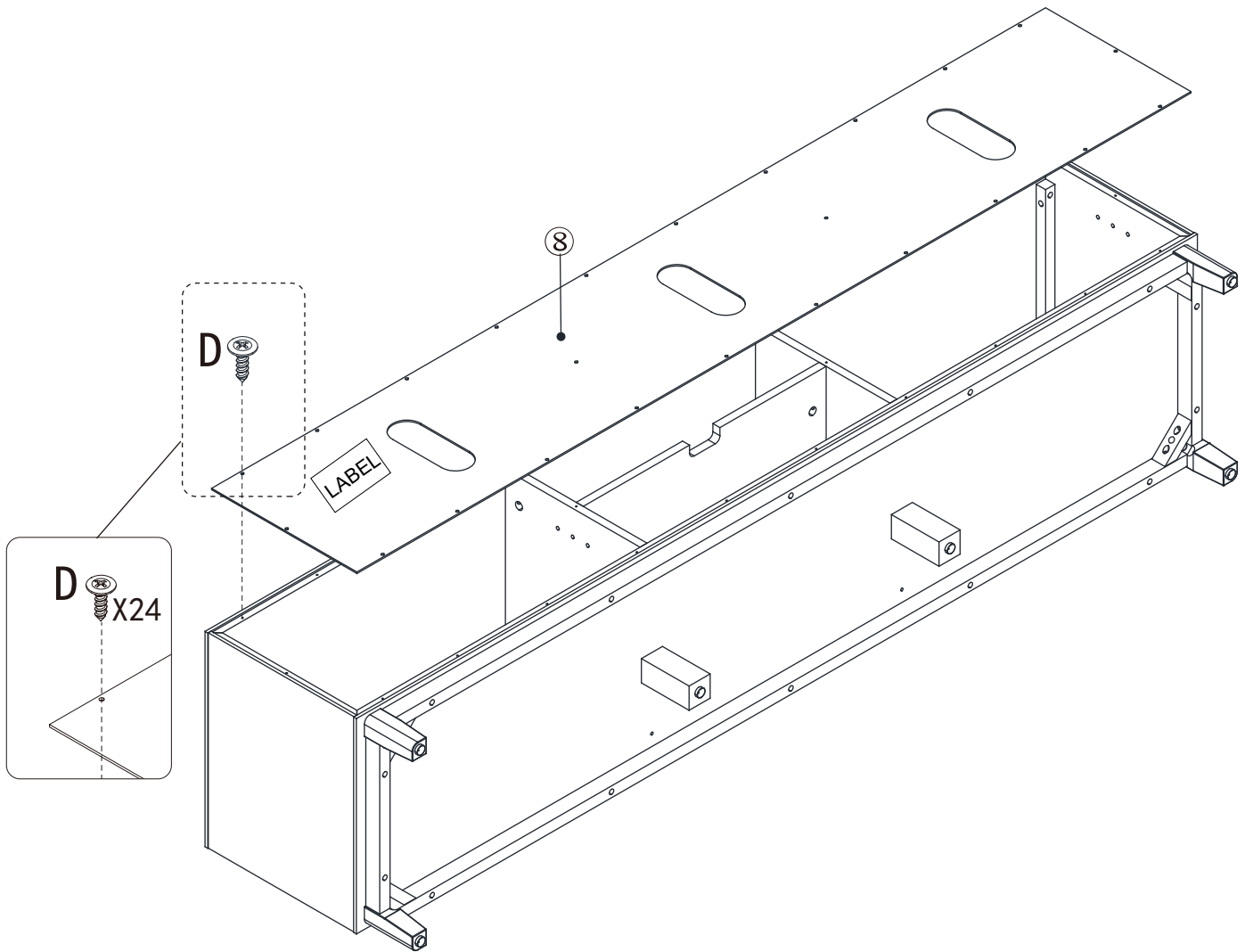



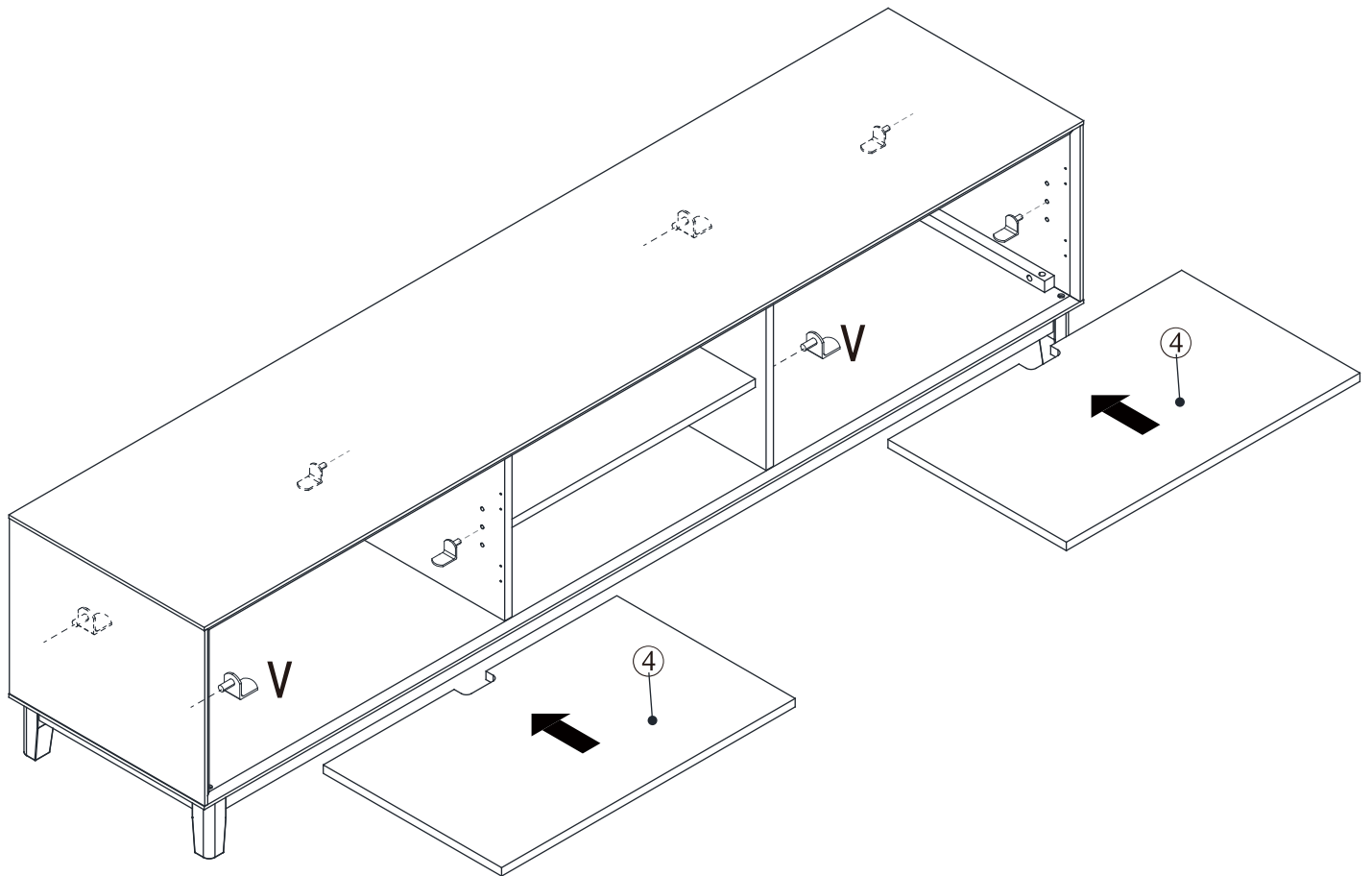



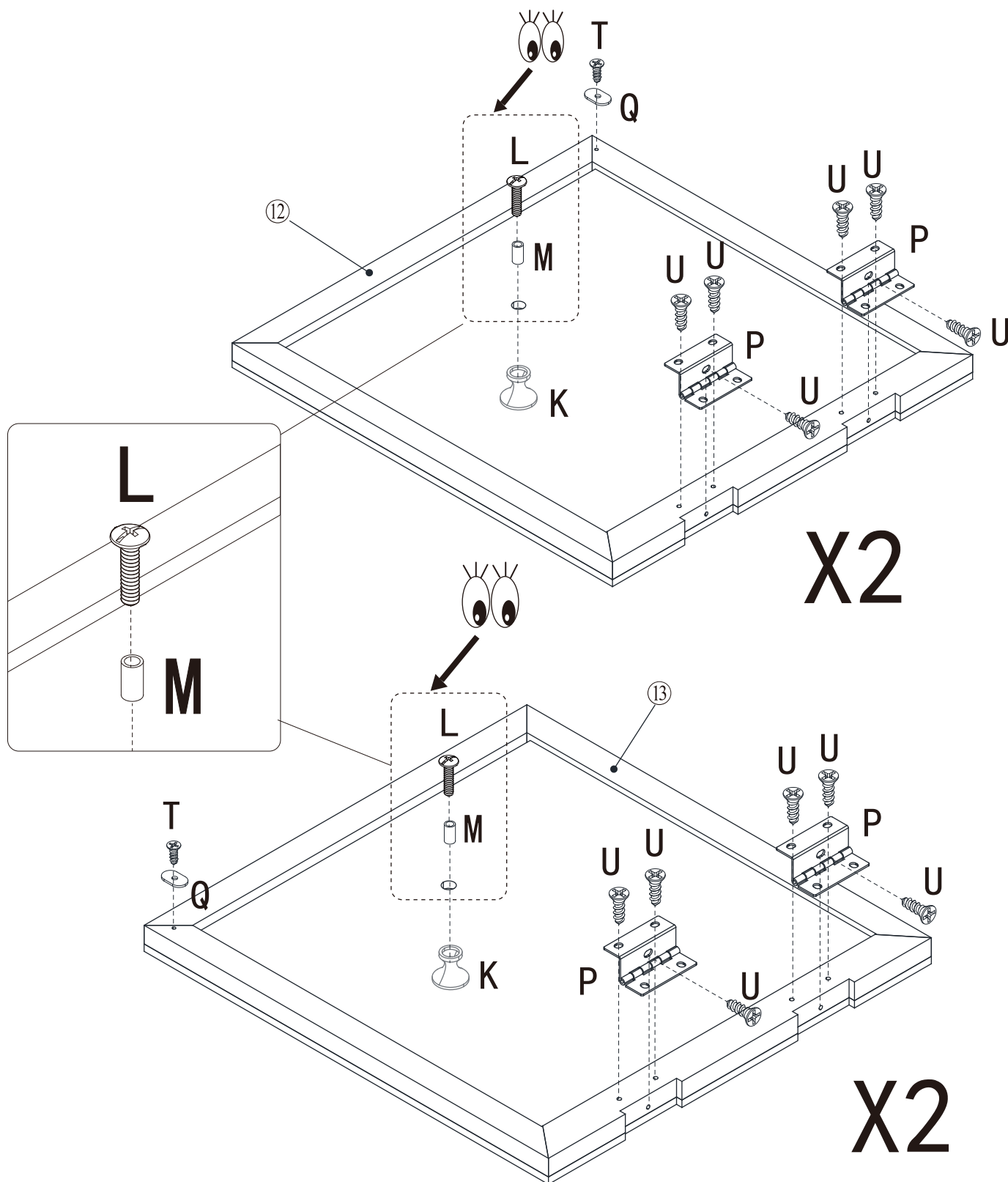

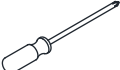
Step10:



Step11:



	Kx4 	Lx4 	Mx4 	Px8 	Qx4 	Tx4 	Ux24 
---	--	--	--	--	--	--	---

Step 12:

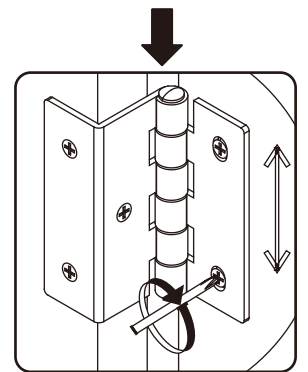
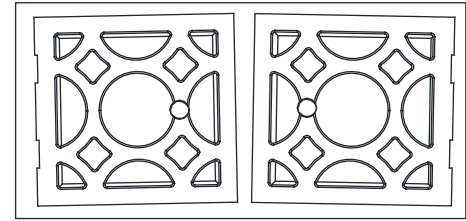
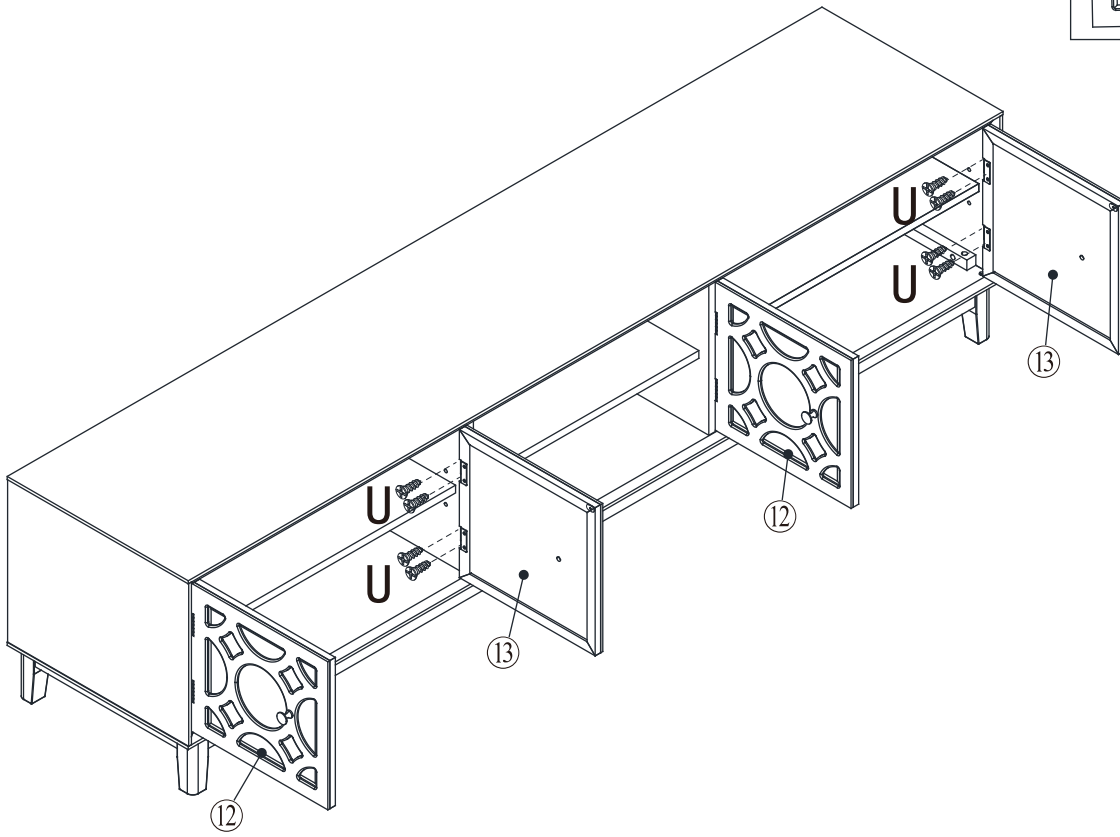

+

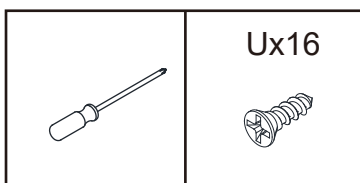
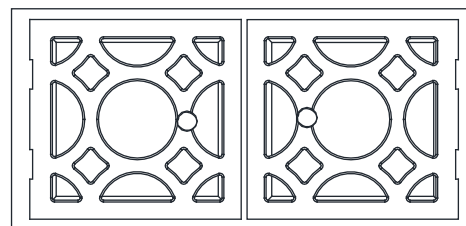
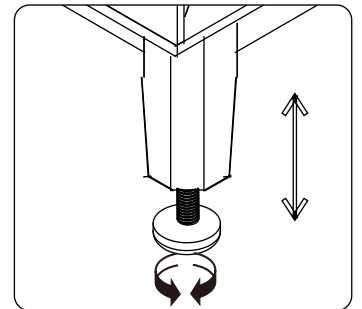

Assembly instructions

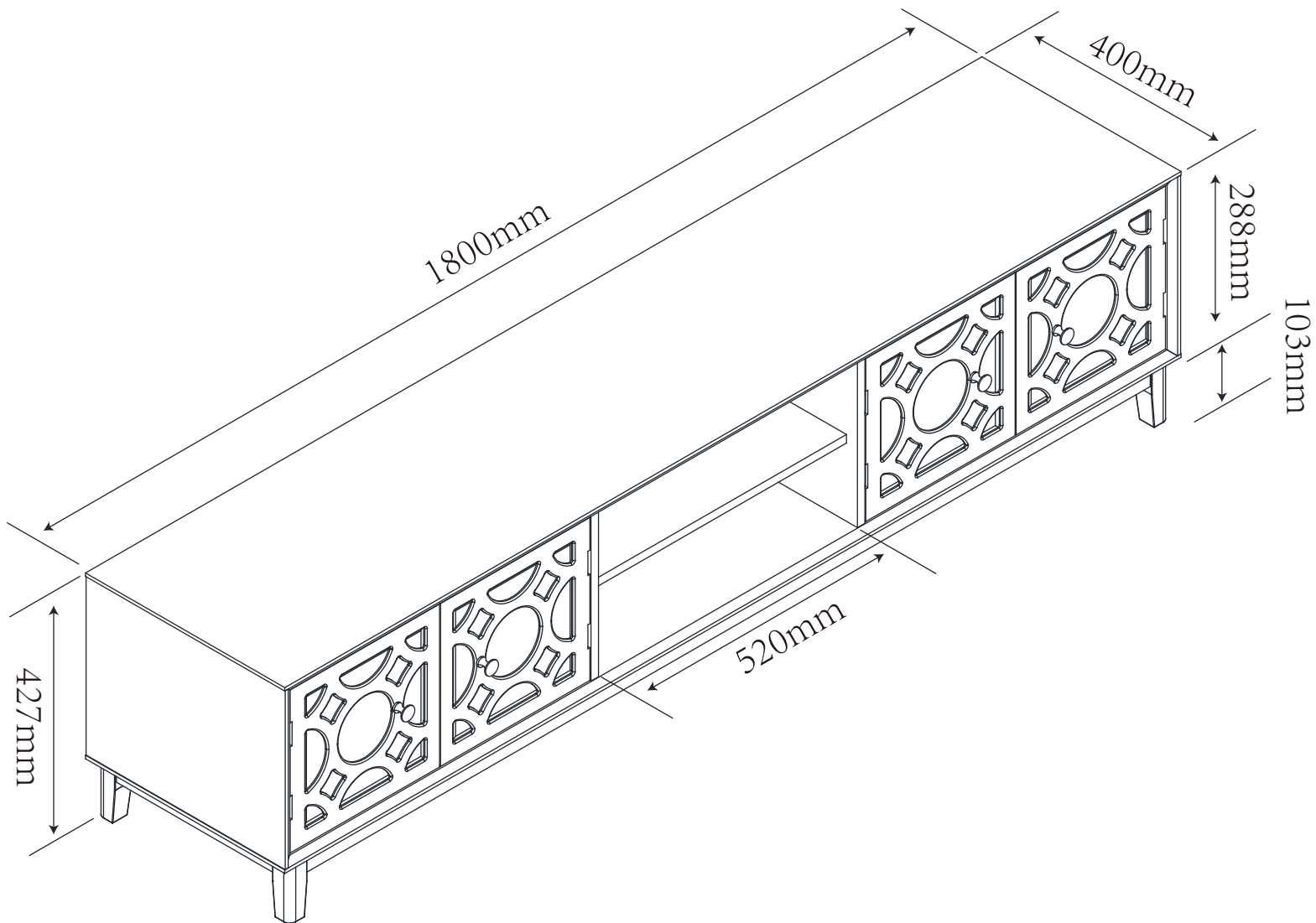

Glass care advice

Regular glass care advice

Do not use glass as a chopping board.

Do not use very hot or very cold items on the glass unless adequate table mats are used to prevent such items coming into direct contact with the furniture.

Do not strike the glass with hard or pointed items.

Do not use abrasive cleaners on the glass as these may scratch and damage the glass.

To clean your item, please use a soft cloth slightly dampened with water and wipe clean.

Then buff with a dry clean cloth. Use washing up liquid if necessary.

If the glass is chipped or broken, stop using the product and consult Dunelm.

Wood care advice

Wood care advice

Wood is a natural product and each piece is individual.

As a natural product, wood is affected by temperature and humidity. We recommend that you avoid placing the furniture directly in front of heat sources such as radiators or fires as this can cause cracking or warping over time.

The colour will mellow over time and new items can vary in shade from items that you have already purchased.

Strong direct sunlight can affect the colour dramatically, so try to avoid this as much as possible, we also recommend that any ornaments, coasters and items placed on the product are periodically moved around to allow the colour to mellow evenly.

Always use mats and coasters to protect the surface when placing items on the furniture. This will help to protect the finish from heat, liquids or items that might scratch your furniture.

If items are to be placed on the surface of your furniture and have rubber feet, it is advisable to use mats to prevent marking.

Always lift your furniture into place, avoid dragging it across the floor as this can cause damage to joints.

When placing furniture on a wooden or laminate floor, please ensure that the plastic or felt protectors are securely fitted and in place.

Only clean using a damp cloth and mild detergent, do not use bleach or abrasive cleaners.

From time to time check that there are no loose screws on this unit.

Remove any spills immediately to avoid staining.

Dust regularly with a soft lint free cloth or duster.

The use of abrasive polish or silicon based polishes is not advised as these can affect the polished finish and joints over time.

Uneven floors could give the impression that doors of wall units and wardrobes are out of alignment. Be aware of this and compensate if necessary by adjusting the hinges or packing a corner to level the item. Please refer to the instructions, included with your furniture, and adjust accordingly.

If your furniture becomes stained, scratched, chipped or suffers other damage, we recommend professional help is sought to restore it. Please contact our customer services line for recommended agents.

Always follow fitting instructions carefully and retain them for future use.