

## Upholstery care advice

### Regular care advice

Vacuum clean your upholstery at least once a week, dust removal may be improved by pre-soft cloth.

All reversible cushions should be turned daily and excessive soiling and even out wear

### Cushion care

It is essential that all fibre cushions are given a vigorous plumping by shaking and squeezing to redistribute the fibre on a daily basis. This will and lumpy.

### General care advice

For items with wooden legs/ feet never place on a damp floor.

Keep upholstery out of direct sunlight to avoid discolouring.

Do not place the furniture in a conservatory, exce

Avoid sharp items such as toys, jean rivets and buckles coming into contact with the up as these can easily snag, tear or pull the fabric.

To maintain the appearance and durability of your suit, restrain children and pet from climbing and jumping on the sofa.

Leather is a natural product and can display natural marks and characteristics such as healed scars, grain directions and creases. These are natural features not faults. Aniline leather will mark naturally and have a antiqur affect after years of use, this is part of the nature of the leather. Care for the leather is required to matain it over the years.

Velvet has a directional pile resulting in colour change when the pile is brushed the wrong way or when the light catches it. Velvet can easily mark and may appear crushed when new, to resolve this sweep with a clothes brush to refresh the pile. Over time the pile may crush due to wear, but this is a characteristic of the velvet. For extreme crashes the pile can be restored by steaming but consult a professional first.

### For accidental spills or stains

Don't rub or scrub with a cloth as this could damage the fabric and remove the colour.

Don't use washing up liquid, detergents or bleach to remove stains.

Don't soak or allow fabric to become wet.

Do blot or soak up spills immediately using a dry soft colourfast cloth.

Do use specialist upholstery cleaner if needed, always follow the manufacturer抐 instructions and always test on a hidden area to check colour fastness.

# Kendall Office Chair

## INSTRUCTION

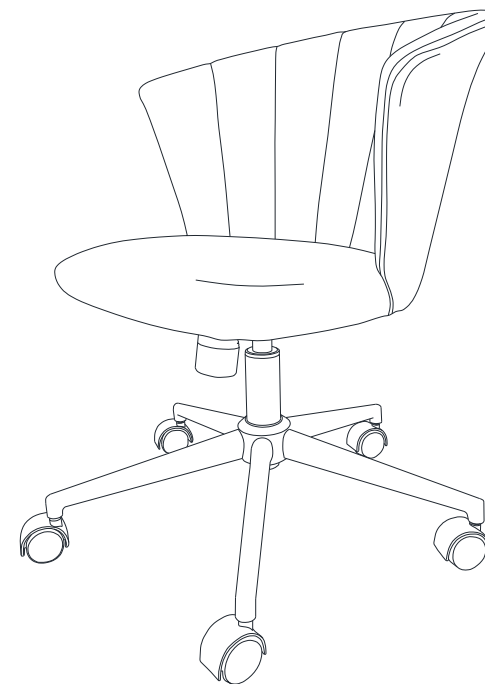

**Dunelm**  
www.dunelm.com

## Dear Customer

Check the pack and make sure you have all the parts listed below. If not, contact the helpline on (+86 22)23862365 who will be able to help you

## Safety and care advice

**IMPORTANT** - The first step you need to take is to ensure your safety! Please take the time to read and understand these instructions before assembling your furniture.

Please keep these instructions for future reference.

Keep children and animals away from the assembly area. This furniture contains small parts that could cause choking if swallowed.

Keep all plastic wrapping materials away from babies and children to avoid danger of suffocation.

Ensure that all packaging is disposed of carefully and responsibly.

From time to time check that there are no loose fittings on the unit, re-tighten when necessary.



Two people may be required for the assembly of this product.







Once items are part or fully assembled they are not returnable unless faulty.

This item is not for outdoor use - unless stated otherwise.

Some items will be supplied with a wall fixing strap, which we recommend is used to secure the item to the wall, to prevent a child from accidentally pulling furniture over. Furniture can be dangerous if incorrectly installed. Assembly should be carried out by a competent person. No liability will be accepted for damage or injury caused by incorrectly installed or assembled

## Parts and fittings

Ref	Name	Dimensions	Visual	Qty
A	Bolt	M6x15mm		4
B	Flat Washer	NA		4
C	Allen Key (provided)	M4		1

Ref	Name	Dimensions	Visual	Qty
1	Seat			1
2	Five-Star base			1
3	Lifting gear			1
4	Cylinder			1
5	wheel			5
6	Cap			1

①

Please install 5 wheels with five-star base first.

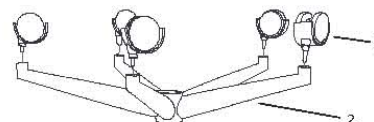

②

Put the cap on top of metal base.

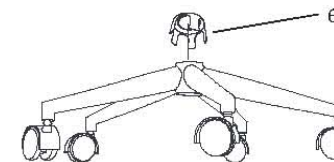

③

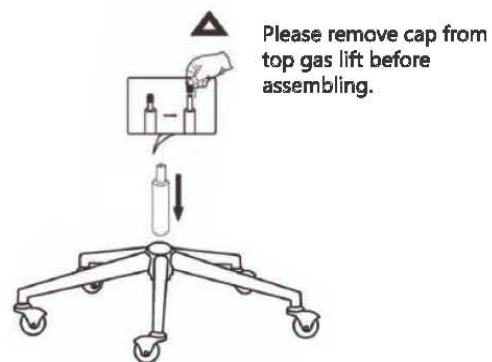

⑤

## Tilt Tension

Knob underneath seat adjusts ease with which chair reclines to the different weights and strengths of different users.

To increase tension turn knob clockwise.  
To release tension (loosen), turn knob counter clockwise.

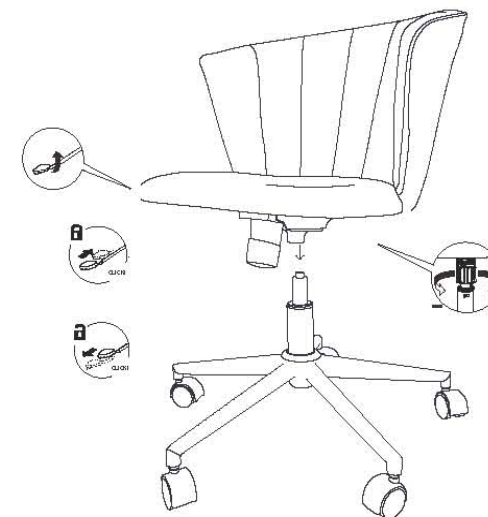

Press the lever up to adjust seat height  
Pull out the lever to unlock rocking mechanism

④

