

GREY PU WAVERLEY 3' STORAGE BED ASSEMBLY INSTRUCTIONS

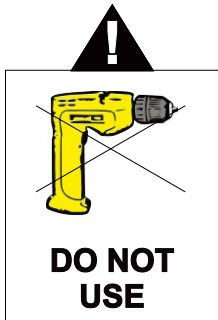

**MAX BED
WEIGHT**

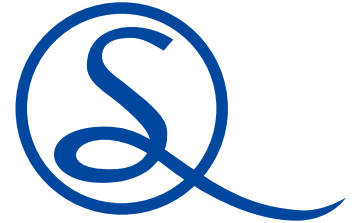
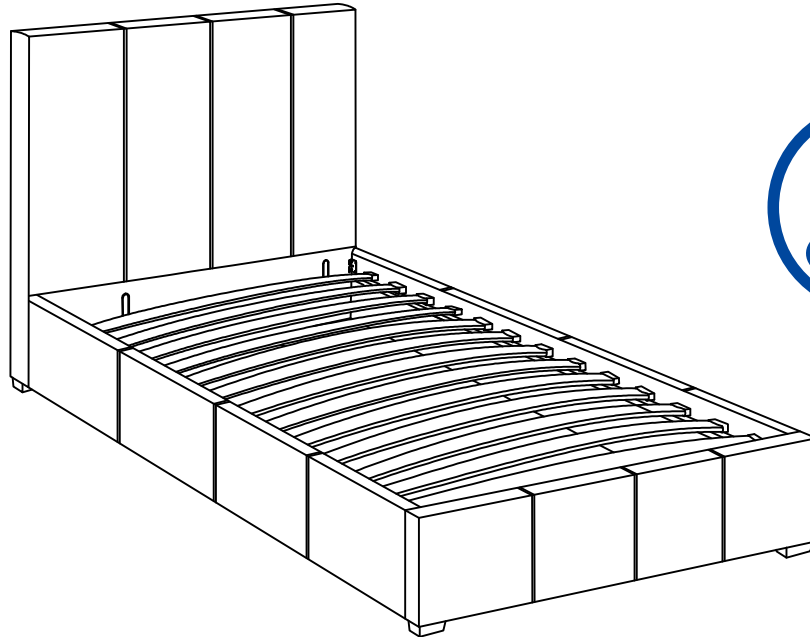

**MAX MATTRESS
WEIGHT**

**FOR DOMESTIC USE ONLY
IMPORTANT**

PLEASE READ BEFORE YOU CONTINUE FURTHER

THE PRODUCT YOU HAVE PURCHASED WILL GIVE YOU MANY YEARS OF SERVICE IF YOU FOLLOW THE GUIDELINES FOR ITS SAFE ASSEMBLY AND PERIODIC MAINTENANCE AND CLEANING.

ASSEMBLE ON A SOFT CLEAN SURFACE.

DO NOT USE ANY TOOLS OTHER THAN THOSE SHOWN.

ANY SPANNERS OR ALLEN KEYS REQUIRED ARE INCLUDED WITH THE FITTINGS KIT.

DO NOT FOR ANY REASON USE A POWER TOOL TO ASSEMBLE THIS PRODUCT. ITS USE WILL INVALIDATE ANY CLAIM YOU MAY HAVE AND COULD MAKE THIS PRODUCT UNSAFE.

DEPENDING ON THE AMOUNT OF USE THIS PRODUCT RECEIVES IT MAY BE NECESSARY TO TIGHTEN UP THE FIXINGS FROM TIME TO TIME. THIS IS COMPLETELY NORMAL FOR ANY FLAT PACK FURNITURE.

DO NOT OVERTIGHTEN FIXINGS.

FOR CLEANING, YOU MAY USE A DAMP CLOTH (NOT WET) DO NOT USE POLISH, DETERGENT OR CHEMICAL CLEANERS

THIS PRODUCT MAY STAIN OR MARK IF ALLOWED TO COME INTO CONTACT WITH WET OR DAMP OBJECTS AS MATERIALS USED HAVE NOT BEEN SCOTCH GUARDED.

THE SURFACE OF THIS ITEM IS NOT HEAT RESISTANT. ALWAYS USE A PLACE MAT UNDER HOT OR COLD ITEMS TO PREVENT MARKING.

PART LIST

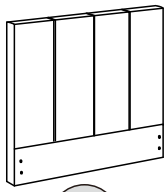

1

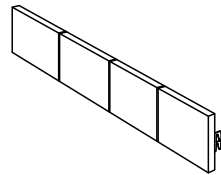

2

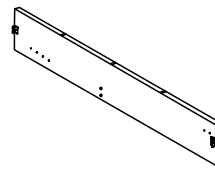

3

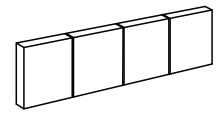

4

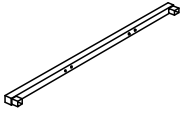

5

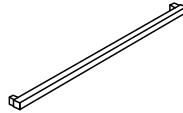

6

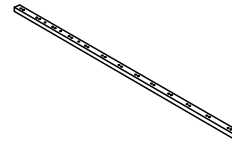

7

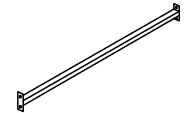

8

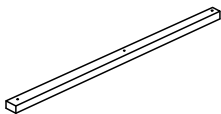

9



10



11



12



13

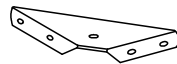

14

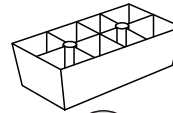

15

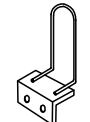

16

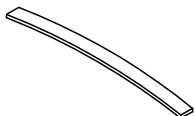

17

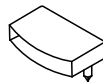











18



19

Part Number	Part Code	Part Description	Quantity	Carton
1	S200-201-056-BY1-01	Headboard	1	1/2
2	S200-201-056-BY1-02	Footboard	1	2/2
3	S200-201-056-BY1-03	Left Side Rail	1	2/2
4	S200-201-056-BY1-04	Right Side Rail	1	2/2
5	S200-201-056-BY1-05	Front Frame Rail	1	2/2
6	S200-201-056-BY1-06	Back Frame Rail	1	2/2
7	S200-201-056-BY1-07	Front Side Rail	2	2/2
8	S200-201-056-BY1-08	Centre Frame Rail	1	2/2
9	S200-201-056-BY1-09	Crossrail	1	2/2
10	S200-201-056-BY1-10	Strap	1	2/2
11	S200-201-056-BY1-11	Left Lifting Arm	1	2/2
12	S200-201-056-BY1-12	Right Lifting Arm	1	2/2
13	S200-201-056-BY1-13	Gas Lift	2	2/2
14	S200-201-056-BY1-14	Corner Bracket	2	2/2
15	S200-201-056-BY1-15	Feet	4	2/2
16	S200-201-056-BY1-16	Mattress Support	2	2/2
17	S200-201-056-BY1-17	Sprung Slats	13	1/2
18	S200-201-056-BY1-18	Plastic Slat Caps	26	2/2
19	S200-201-056-BY1-19	Woven Fabric	1	1/2

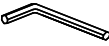
HARDWARE LIST

REF		HARDWARE NAME	QTY
A		5/16x2" BOLT	2 PCS
B		5/16x1" BOLT	8 PCS
C		5/16x3/4" BOLT	4 PCS
D		1/4x3/4" BOLT	30 PCS
E		5/16"x19mm FLAT WASHER	44 PCS
F		5/16"x13mm SPRING WASHER	26 PCS
G		5/16"x12mm	6 PCS
H		#7*1-1/2 Screw	8 PCS
I		M4 ALLEN KEY	1 PC
J		M5 ALLEN KEY	1 PC
K		12mm SPANNER	1 PC

**PLEASE CHECK THAT YOU HAVE ALL THE PARTS LISTED
BEFORE YOU START ASSEMBLING. IF YOU DO FIND THAT
SOMETHING IS MISSING. DO NOT CONTINUE ASSEMBLY.
PLEASE CONTACT YOUR SUPPLIER IMMEDIATELY.**

IMPORTANT INFORMATION !

GAS STRUT 450N MAXIMUM MATTRESS WEIGHT 30KG !!

The gas lifts used in the construction of this product are extremely strong and cannot be operated by hand when not fitted to the ottoman hinges. All gas lifts are tested in the factory for correct pressure and operation before use.

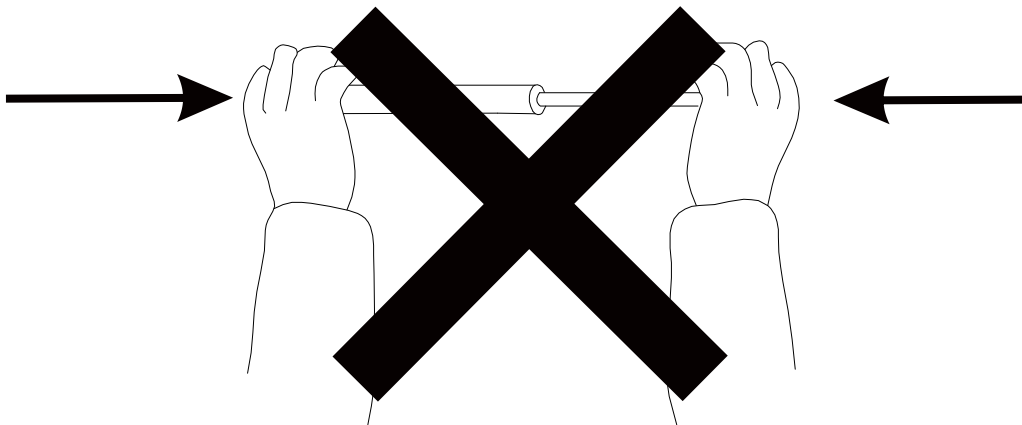

You must ensure the **MATTRESS** is on the bed frame before lifting the mechanism. Always use the handle to open and close the ottoman. **FAILURE TO DO SO MAY RESULT IN INJURY.**

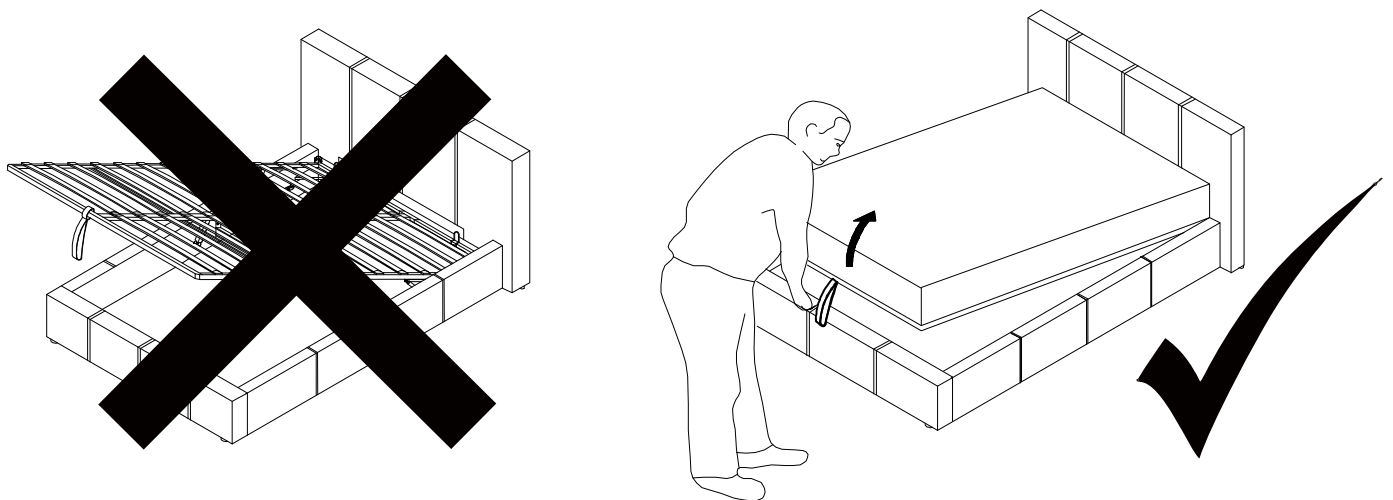

Initially it might appear that the gas lifts are very stiff when opening and closing the ottoman frame, **THIS IS NORMAL.**

After operating the ottoman a few times, the movement of the gas lifts and the opening and closing of the ottoman will become easier.

STEP 1

PARTS REQUIRED

1 - HEADBOARD	x1
15 - FEET	x2

HARDWARE REQUIRED

H		04
---	---	----

TOOLS REQUIRED

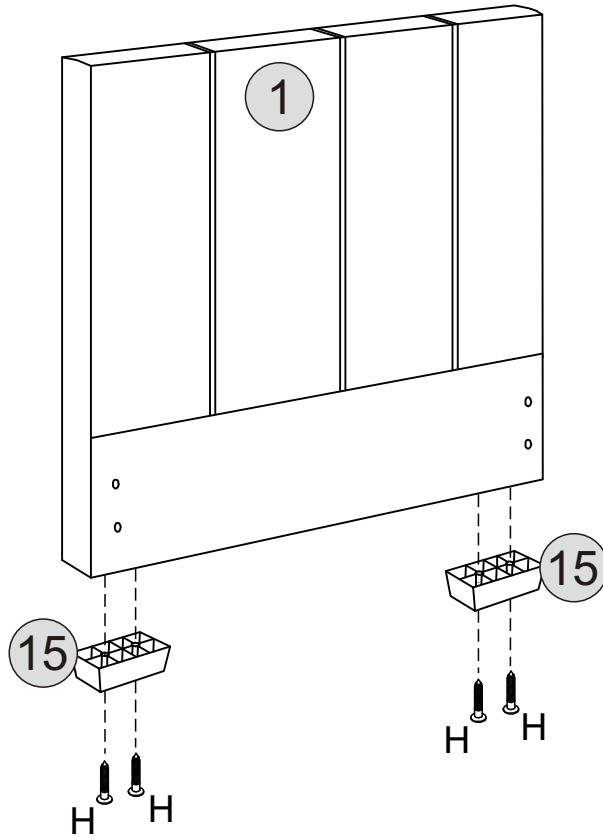
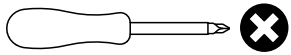

STEP 2

PARTS REQUIRED

2 - FOOTBOARD	x1
15 - FEET	x2

HARDWARE REQUIRED

H		04
---	---	----

TOOLS REQUIRED

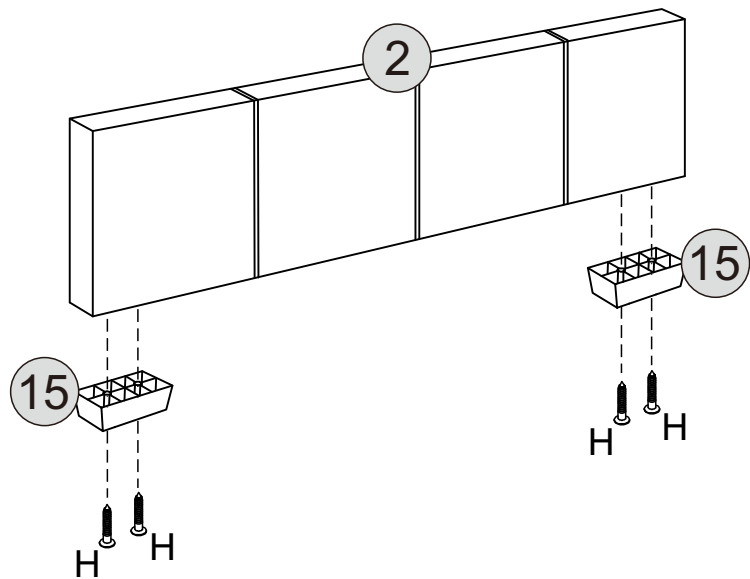
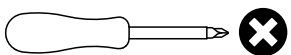



STEP 3

PARTS REQUIRED

1 - HEADBOARD	x1
2 - FOOTBOARD	x1
3 - LEFT SIDERAIL	x1
4 - RIGHT SIDERAIL	x1

HARDWARE REQUIRED

B		08
E		08
F		08

TOOLS REQUIRED

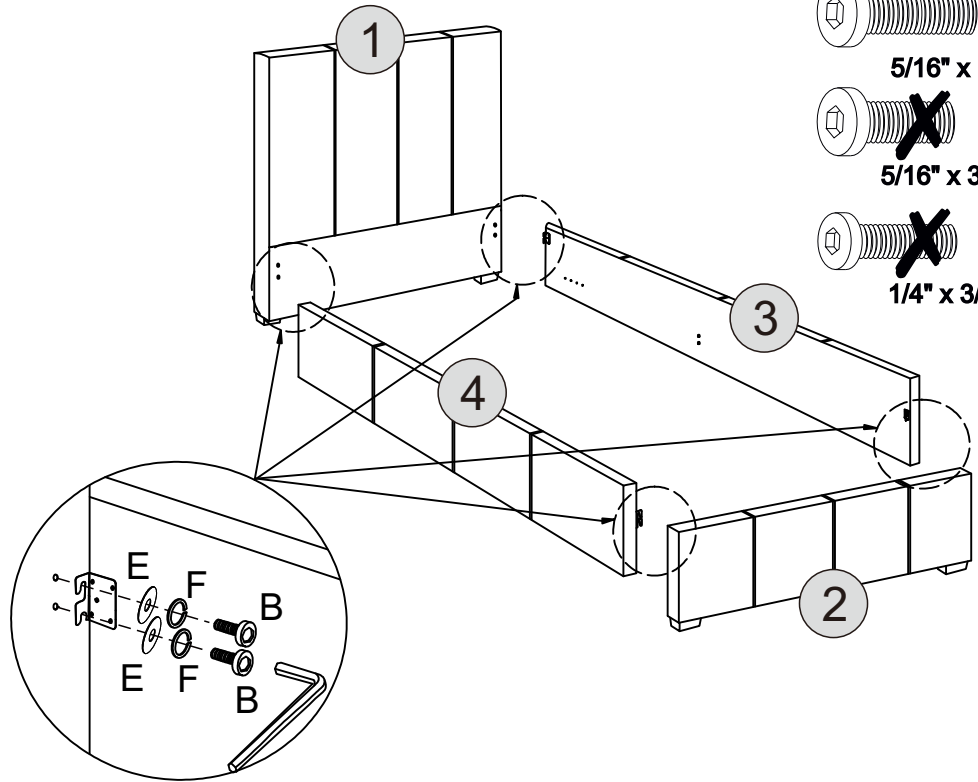
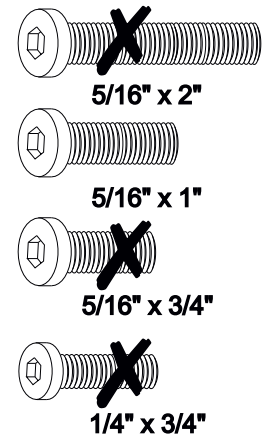
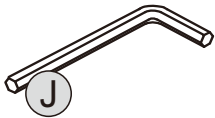



STEP 4

PARTS REQUIRED

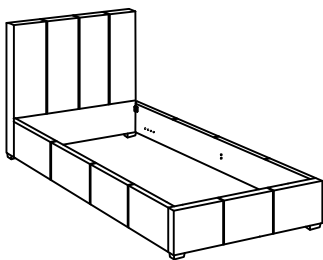
14 - CORNER BRACKET	x2
---------------------	----



HARDWARE REQUIRED

D		08
E		08

TOOLS REQUIRED

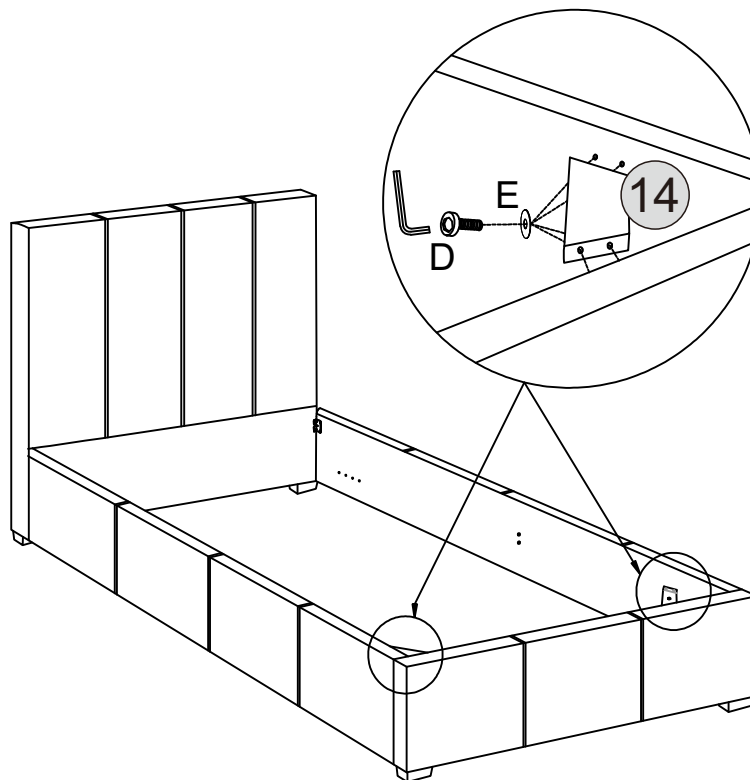
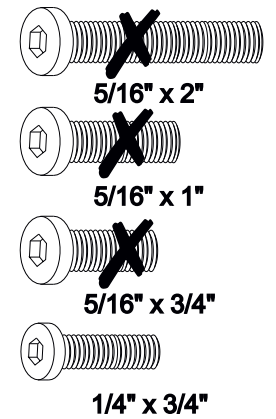



STEP 5

PARTS REQUIRED

5 - FRONT FRAME RAIL	x1
6 - BACK FRAME RAIL	x1
7 - FRONT SIDE RAIL	x2
10 - STRAP	x1

HARDWARE REQUIRED

C		04
E		04
F		04

TOOLS REQUIRED

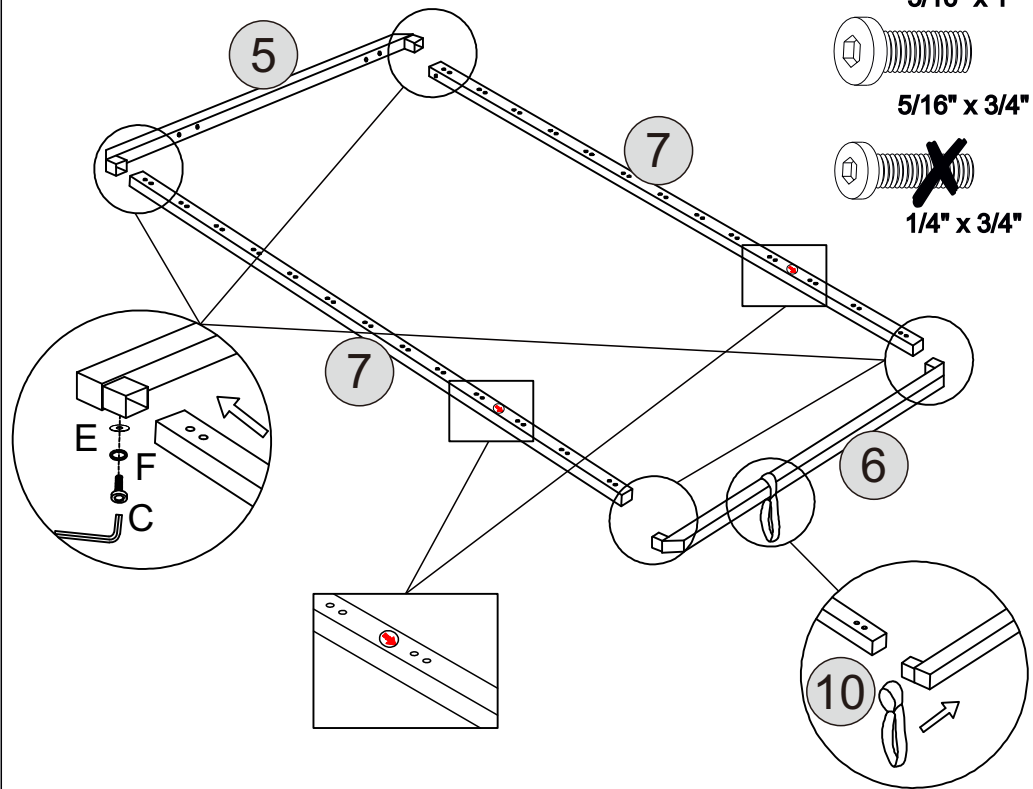
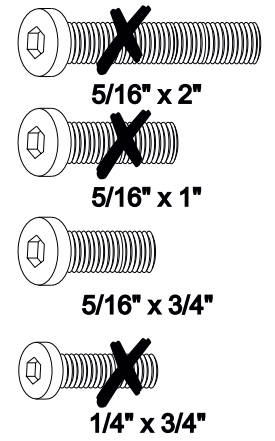
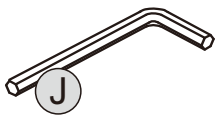



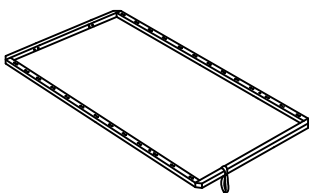

STEP 6

PARTS REQUIRED

9 - CROSSRAIL	x1
16 - MATTRESS SUPPORT	x2



HARDWARE REQUIRED

A		02
D		04
E		06
F		06
G		02

TOOLS REQUIRED

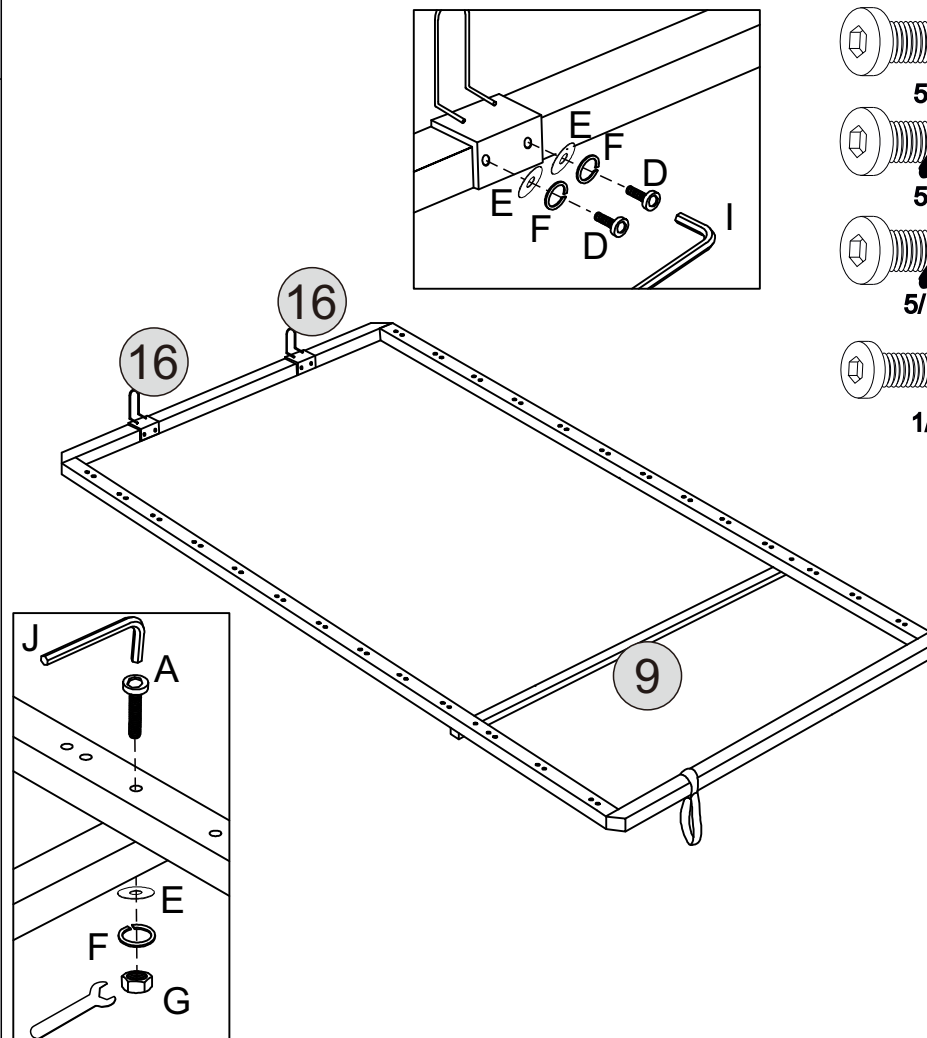
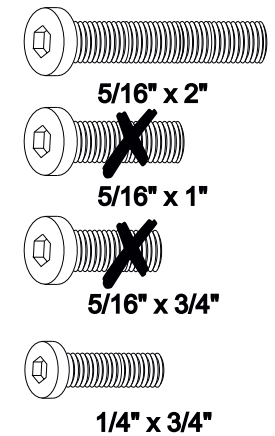
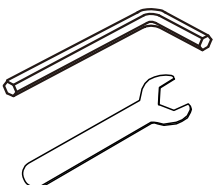

STEP 7

PARTS REQUIRED

11 - LEFT LIFTING ARM	x1
12 - RIGHT LIFTING ARM	x1
13 - GAS LIFT	x2

HARDWARE REQUIRED

G		04
---	---	----

TOOLS REQUIRED

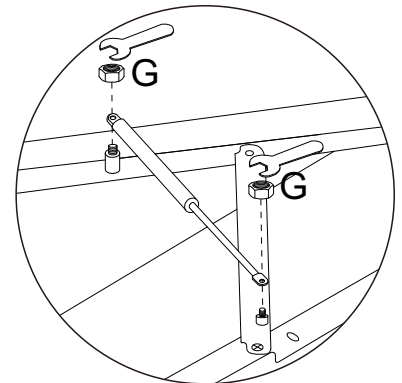
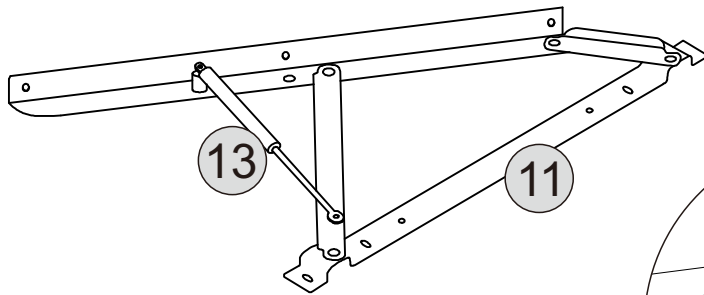
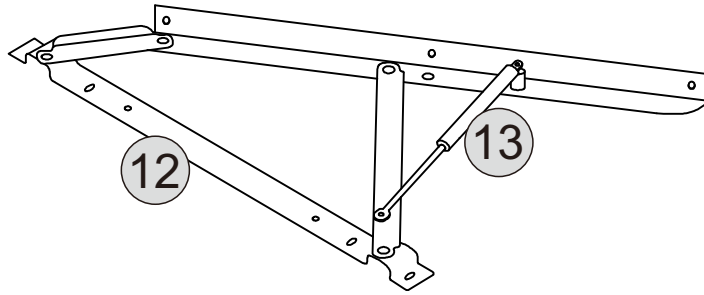
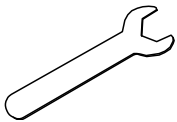



STEP 8

PARTS REQUIRED

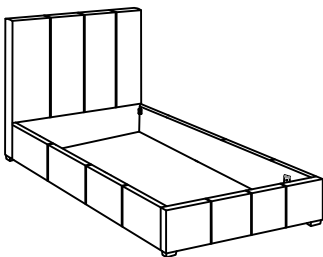
8 - CENTRE FRAME RAIL	x1
11 - LEFT LIFTING ARM	x1
12 - RIGHT LIFTING ARM	x1



HARDWARE REQUIRED

D		12
E		12
F		08

TOOLS REQUIRED

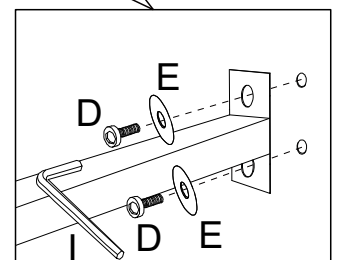
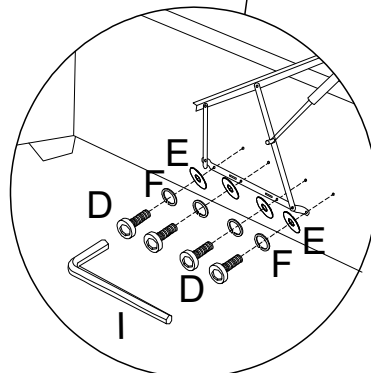
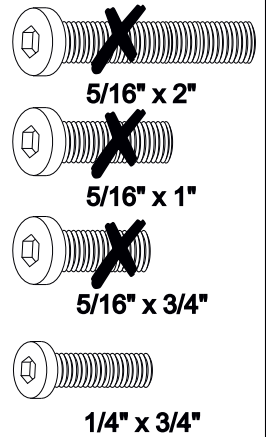
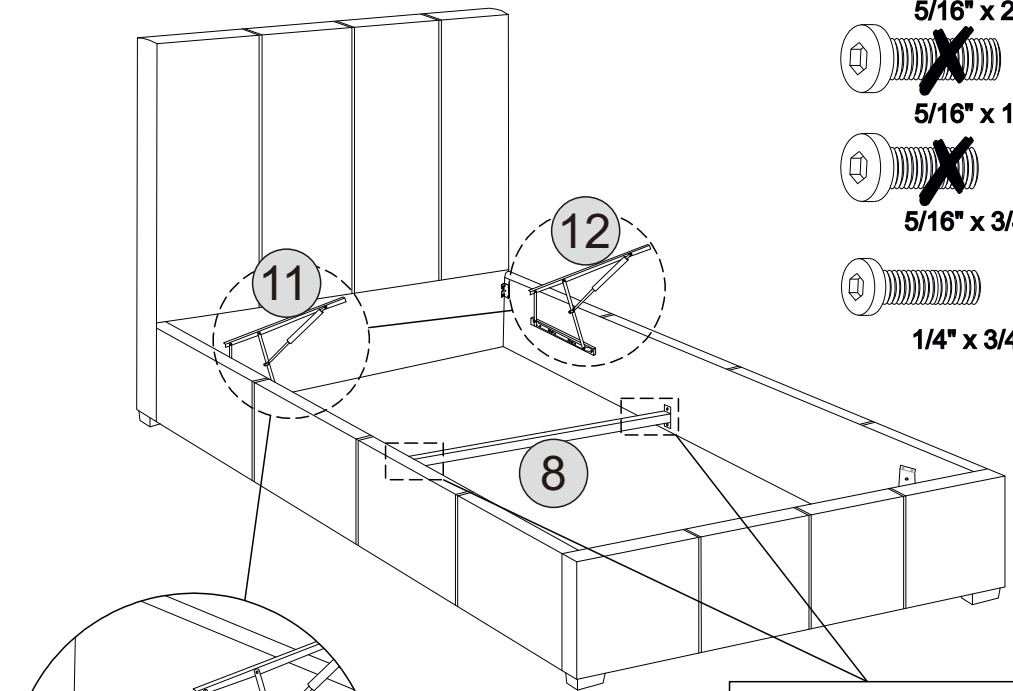

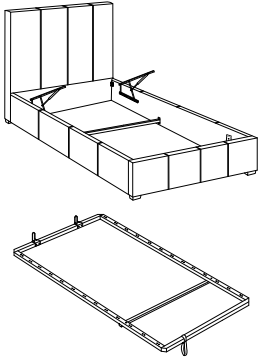

STEP 9

PARTS REQUIRED



HARDWARE REQUIRED

D	 1/4" x 3/4"	06
E		06

TOOLS REQUIRED

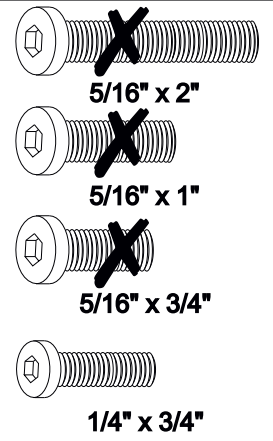
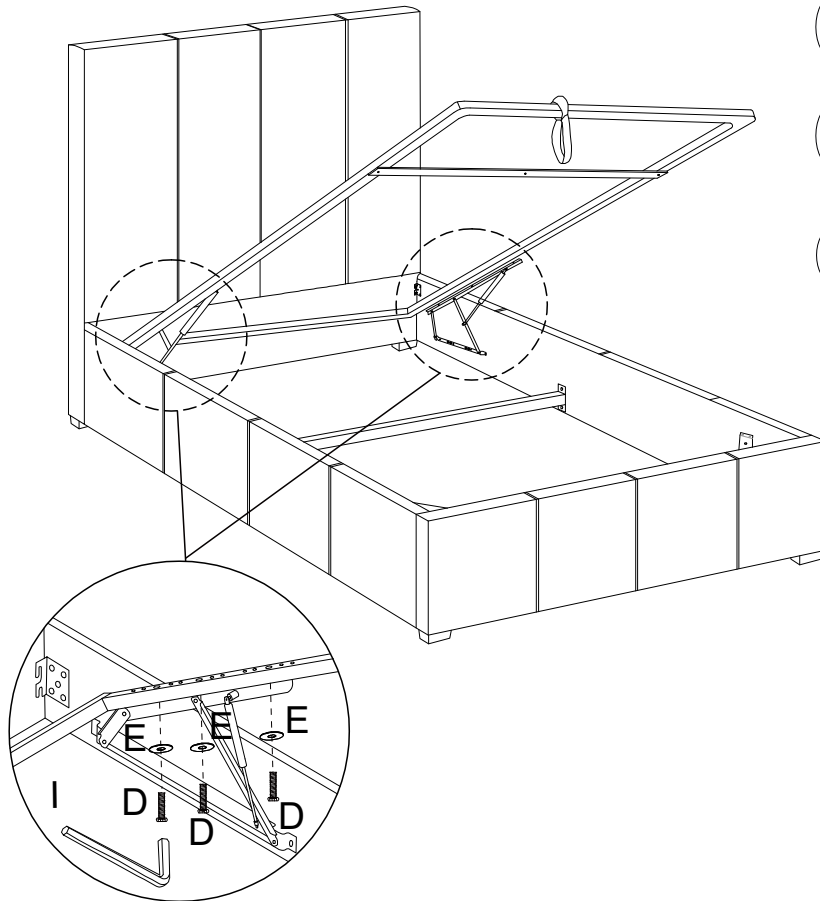
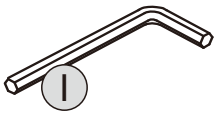

STEP 10

PARTS REQUIRED

19 - WOVEN FABRIC	x1
-------------------	----

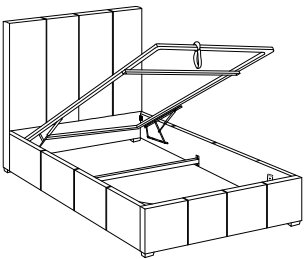

HARDWARE REQUIRED

TOOLS REQUIRED

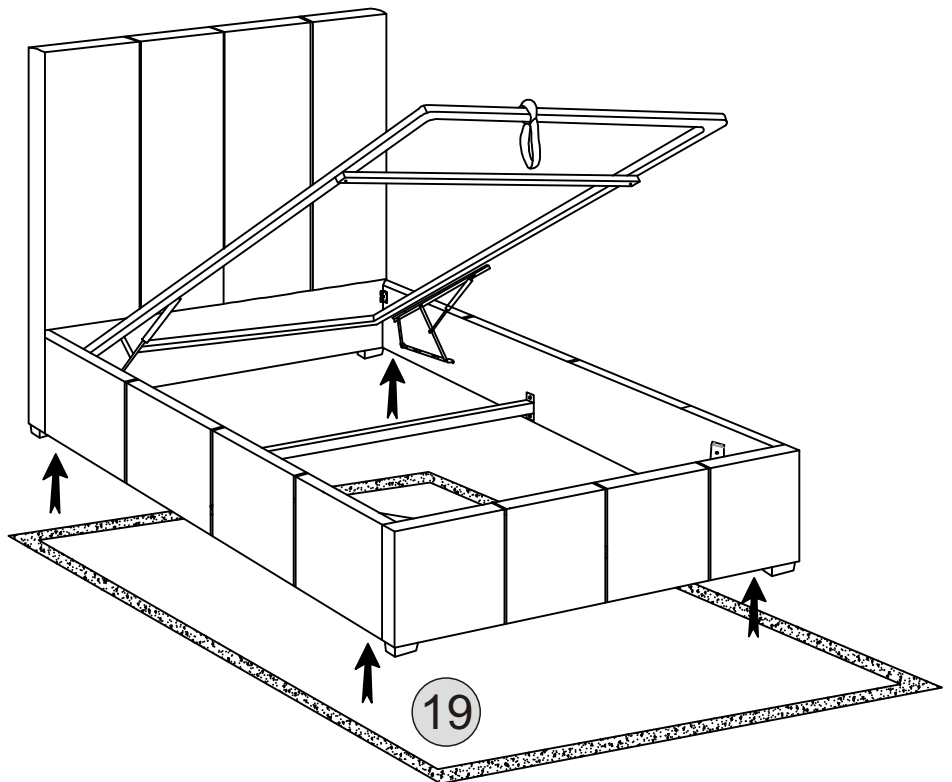

STEP 11

PARTS REQUIRED

17 - SPRUNG SLATS x13

18 - PLASTIC SLAT CAPS x26

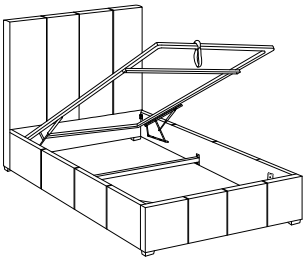

HARDWARE REQUIRED

TOOLS REQUIRED

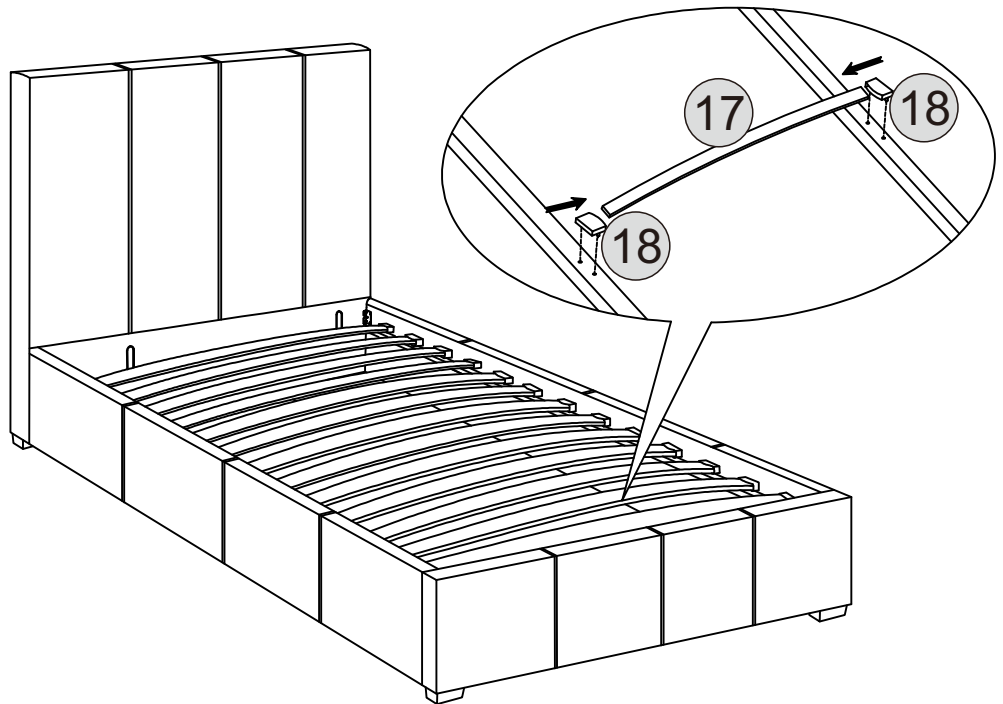

STEP 12

PARTS REQUIRED

HARDWARE REQUIRED

TOOLS REQUIRED

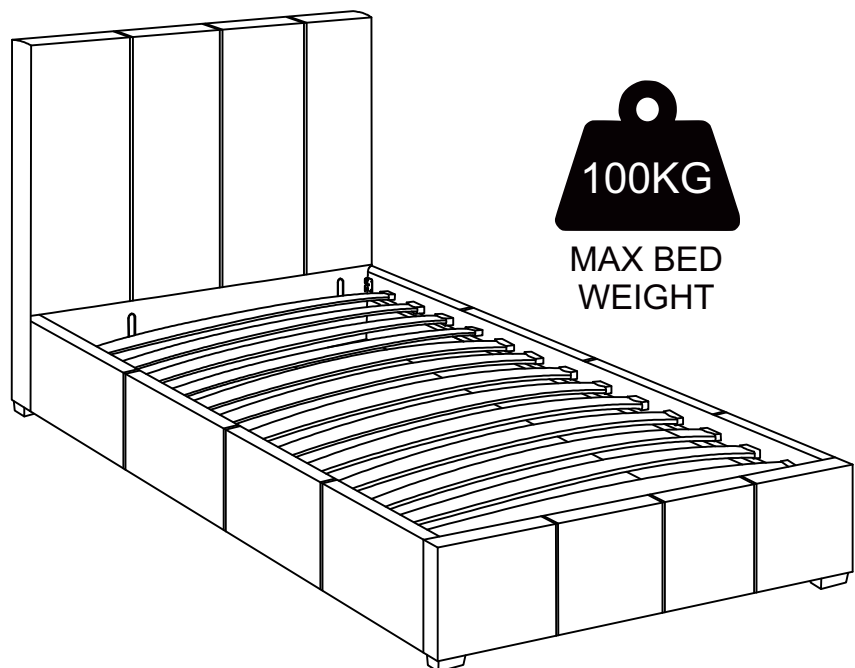

INFORMATIONS IMPORTANTES (FRENCH)**IMPORTANTE
POUR USAGE DOMESTIQUE UNIQUEMENT
VEUILLEZ LIRE AVANT DE CONTINUER**

Le produit que vous avez acheté vous offrira de nombreuses années de service si vous suivez les directives pour son assemblage sûr et son entretien et nettoyage périodiques.

Montez sur une surface douce et propre.

N'utilisez aucun autre outil que ceux indiqués.

Toutes les clés ou clés Allen nécessaires sont fournies avec le kit de fixation.

N'utilisez en aucun cas un outil électrique pour assembler ce produit.

Son utilisation invalidera et pourrait rendre ce produit dangereux.

En fonction de la quantité d'utilisation de ce produit, il peut être nécessaire de resserrer les fixations de temps en temps. Cela est tout à fait normal pour tout meuble en kit.

Pour le nettoyage, vous pouvez utiliser un chiffon humide (pas mouillé).

N'utilisez pas de détergent à polir ou de nettoyeurs chimiques.

Ce produit peut tacher ou marquer s'il entre en contact avec des objets mouillés ou humides.

La surface de cet article n'est pas résistante à la chaleur, utilisez toujours un set de table sous les articles chauds ou froids pour éviter les marques.

INFORMACIÓN IMPORTANTE (SPANISH)**IMPORTANTE
SOLO PARA USO DOMÉSTICO
LEER ANTES DE CONTINUAR**

El producto que ha adquirido le brindará muchos años de servicio si sigue las pautas para su montaje seguro y su mantenimiento y limpieza periódicos.

Ensamble sobre una superficie suave y limpia.

No utilice ninguna herramienta que no sea la que se muestra.

Las llaves inglesas o llaves Allen necesarias están incluidas con el kit de accesorios.

No utilice bajo ningún concepto una herramienta eléctrica para ensamblar este producto. Su uso invalidará cualquier reclamación que pueda tener y podría hacer que este producto sea inseguro.

Dependiendo de la cantidad de uso que reciba este producto, puede ser necesario ajustar las fijaciones de vez en cuando. Esto es completamente normal en cualquier mueble de paquete plano.

Para la limpieza, puede utilizar un paño húmedo (no mojado). No utilice detergentes abrillantadores ni limpiadores químicos.

Este producto puede mancharse o marcarse si se deja en contacto con objetos mojados o húmedos.

La superficie de este artículo no es resistente al calor, utilice siempre un mantel individual debajo de los elementos calientes o fríos para evitar marcas.

WICHTIGE INFORMATIONEN (GERMAN)**WICHTIGUR
FÜR DEN HAUSHALTSGEBRAUCH
BITTE LESEN SIE, BEVOR SIE FORTFAHREN**

Das von Ihnen erworbene Produkt wird Ihnen viele Jahre lang gute Dienste leisten, wenn Sie die Richtlinien für eine sichere Montage und regelmäßige Wartung und Reinigung befolgen.

Auf einer weichen, sauberen Oberfläche montieren.

Verwenden Sie keine anderen Werkzeuge als die abgebildeten.

Alle benötigten Schraubenschlüssel oder Inbusschlüssel sind im Montagesatz enthalten.

Verwenden Sie unter keinen Umständen ein Elektrowerkzeug zur Montage dieses Produkts. Bei Verwendung erlischt Ihr Anspruch und das Produkt kann unsicher werden.

Je nach Nutzungsintensität des Produkts kann es von Zeit zu Zeit erforderlich sein, die Befestigungen festzuziehen. Dies ist bei Möbeln aus dem Bausatz völlig normal.

Zum Reinigen können Sie ein feuchtes Tuch verwenden (nicht nass).

Verwenden Sie kein Poliermittel oder chemische Reinigungsmittel.

Dieses Produkt kann Flecken oder Abdrücke hinterlassen, wenn es mit nassen oder feuchten Gegenständen in Kontakt kommt.

Die Oberfläche dieses Artikels ist nicht hitzebeständig. Verwenden Sie immer eine Unterlage unter heißen oder kalten Gegenständen, um Abdrücke zu vermeiden.

INFORMAZIONI IMPORTANTI (ITALIAN)**IMPORTANTE, SOLO PER USO DOMESTICO
SI PREGA DI LEGGERE PRIMA DI
CONTINUARE OLTRE**

Il prodotto che hai acquistato ti garantirà molti anni di servizio se seguirai le linee guida per il suo montaggio sicuro e la manutenzione e pulizia periodiche.

Montare su una superficie morbida e pulita.

Non utilizzare utensili diversi da quelli mostrati.

Tutte le chiavi inglesi o le chiavi a brugola necessarie sono incluse nel kit di raccordi.

Non utilizzare per nessun motivo un elettroutensile per montare questo prodotto. Il suo utilizzo invaliderà e affermerà che potresti avere e potrebbe rendere questo prodotto non sicuro.

A seconda della quantità di utilizzo di questo prodotto, potrebbe essere necessario stringere i fissaggi di tanto in tanto. Ciò è del tutto normale per qualsiasi mobile in kit.

Per la pulizia, puoi utilizzare un panno umido (non bagnato). Non utilizzare detergenti lucidanti o detergenti chimici.

Questo prodotto potrebbe macchiare o segnare se lasciato entrare in contatto con oggetti bagnati o umidi.

La superficie di questo articolo non è resistente al calore, utilizzare sempre un sottopiatto sotto gli oggetti caldi o freddi per evitare segni.