

GREY/NATURAL OAK OXFORD EXTENDING DINING TABLE ASSEMBLY INSTRUCTIONS

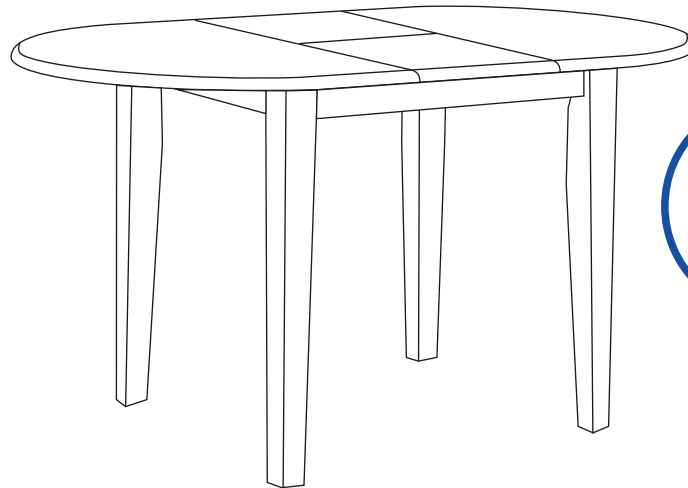

IMPORTANT

FOR DOMESTIC USE ONLY

PLEASE READ BEFORE YOU CONTINUE FURTHER

THE PRODUCT YOU HAVE PURCHASED WILL GIVE YOU MANY YEARS OF SERVICE IF YOU FOLLOW THE GUIDELINES FOR ITS SAFE ASSEMBLY AND PERIODIC MAINTENANCE AND CLEANING.

ASSEMBLE ON A SOFT CLEAN SURFACE.

DO NOT USE ANY TOOLS OTHER THAN THOSE SHOWN.

ANY SPANNERS OR ALLEN KEYS REQUIRED ARE INCLUDED WITH THE FITTINGS KIT.

DO NOT FOR ANY REASON USE A POWER TOOL TO ASSEMBLE THIS PRODUCT. ITS USE WILL INVALIDATE ANY CLAIM YOU MAY HAVE AND COULD MAKE THIS PRODUCT UNSAFE.

DEPENDING ON THE AMOUNT OF USE THIS PRODUCT RECEIVES IT MAY BE NECESSARY TO TIGHTEN UP THE FIXINGS FROM TIME TO TIME.

THIS IS COMPLETELY NORMAL FOR ANY FLAT PACK FURNITURE.

DO NOT OVERTIGHTEN FIXINGS.

FOR CLEANING, YOU MAY USE A DAMP CLOTH (NOT WET). DO NOT USE POLISH, DETERGENT OR CHEMICAL CLEANERS.

THE SURFACE OF THIS ITEM IS NOT HEAT RESISTANT. ALWAYS USE A PLACE MAT UNDER HOT OR COLD ITEMS TO PREVENT MARKING.



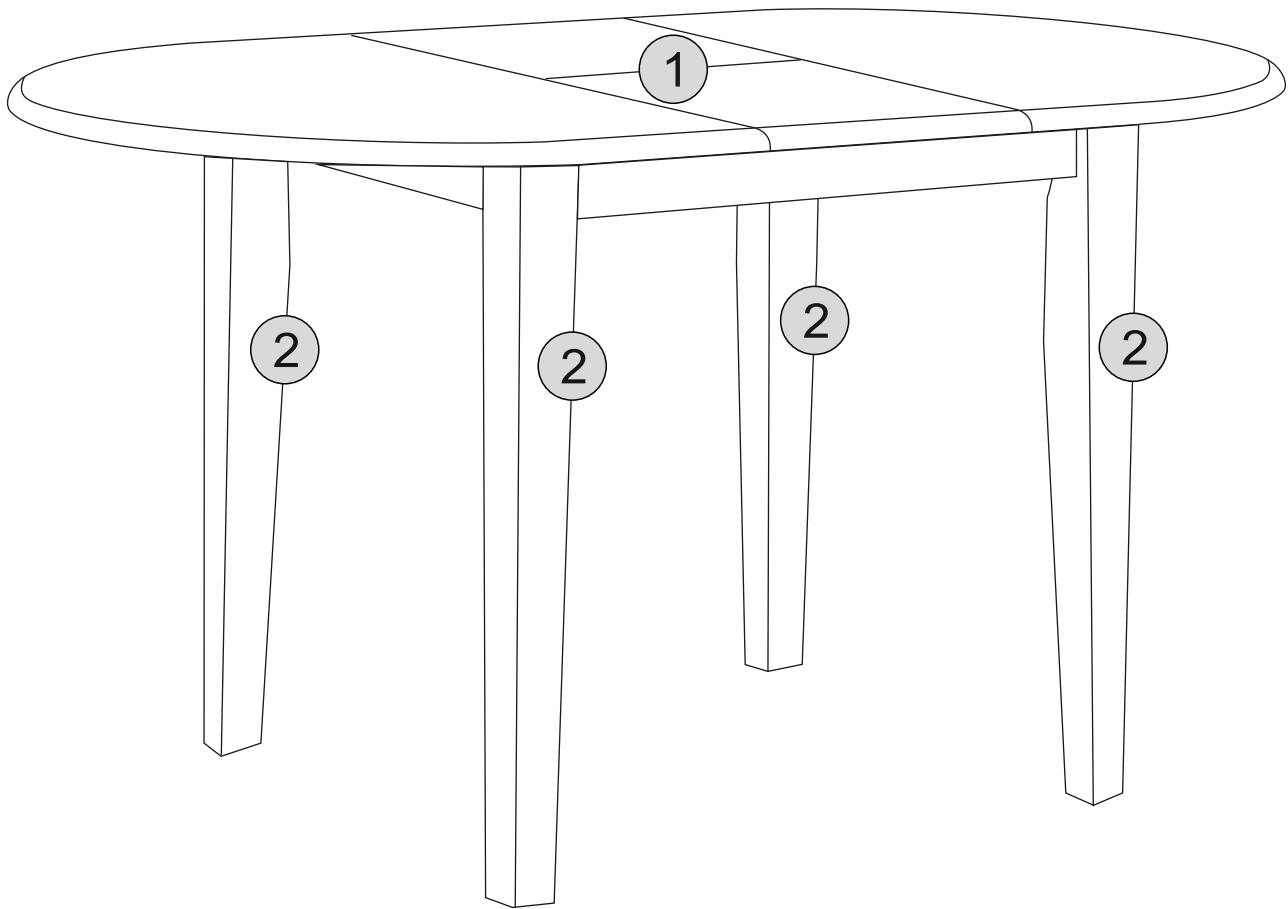

PLEASE CHECK THAT YOU HAVE ALL THE PARTS LISTED BEFORE YOU START ASSEMBLING. IF YOU DO FIND THAT SOMETHING IS MISSING, DO NOT CONTINUE ASSEMBLY. PLEASE CONTACT YOUR SUPPLIER IMMEDIATELY.



PART LIST

Part Number	Part Code	Part Description	Quantity	Carton
1	S400-401-142-PU1-01	Table Top	1	1/1
2	S400-401-142-PU1-02	Table Leg	4	1/1

HARDWARE LIST

No.	Part Name		Qty	Carton
A	JCBC Bolts		x8	1
B	Flat Washer		x8	1
C	Spring Washer		x8	1
D	Allen Key		x1	1

STEP 1

PARTS REQUIRED

1 - TABLE TOP x1

2 - TABLE LEG x4

HARDWARE REQUIRED

A  08

B  08

C  08

TOOLS REQUIRED

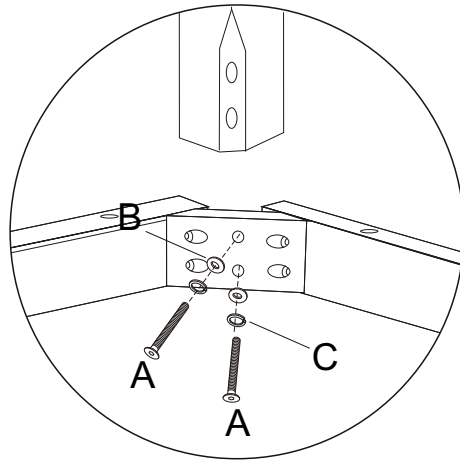

REPEAT THIS ASSEMBLY FOR EACH LEG

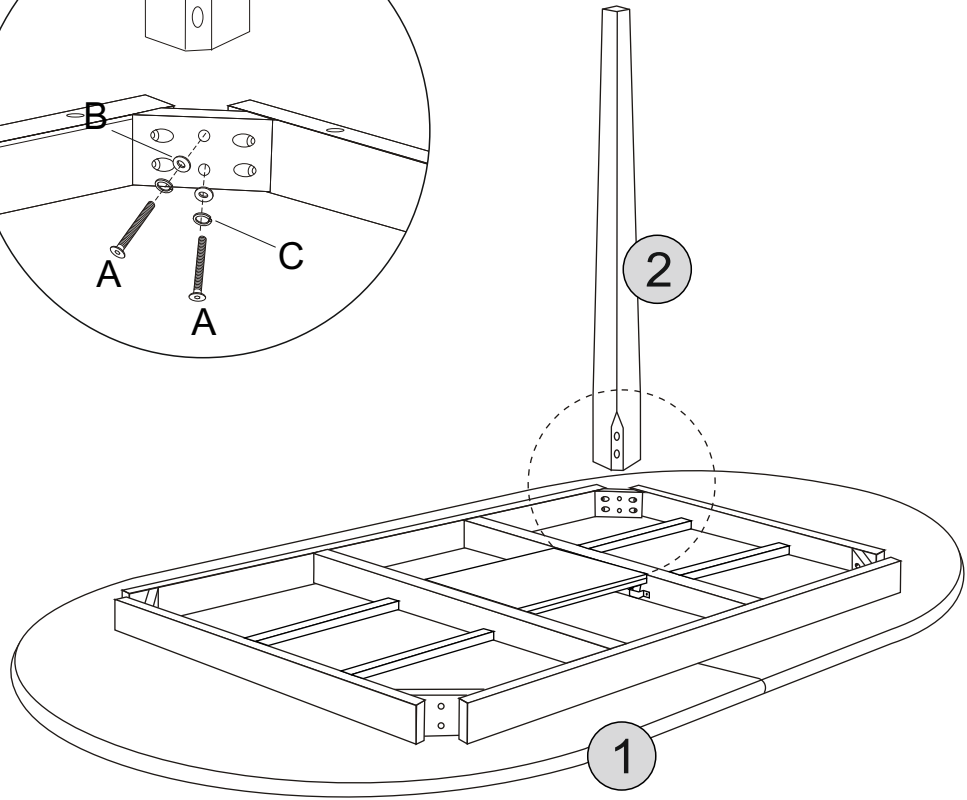

STEP 2

PARTS REQUIRED

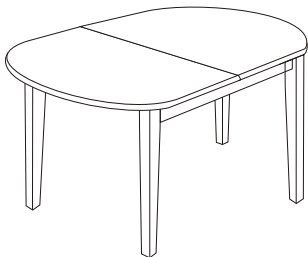

HARDWARE REQUIRED

TOOLS REQUIRED

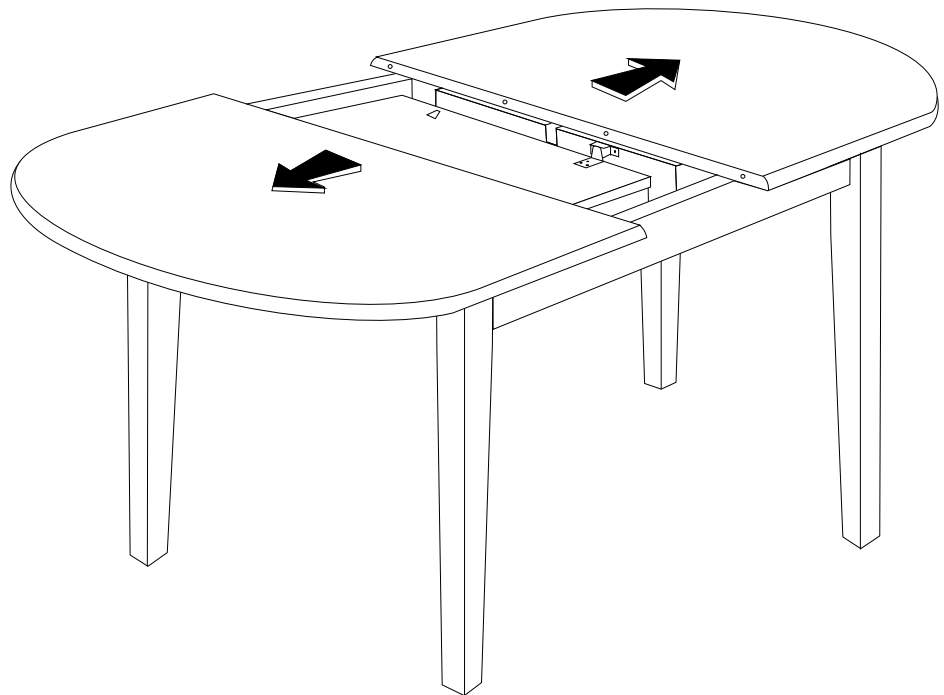

STEP 3

PARTS REQUIRED

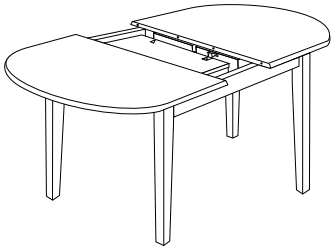

HARDWARE REQUIRED

TOOLS REQUIRED

FLIP ↶

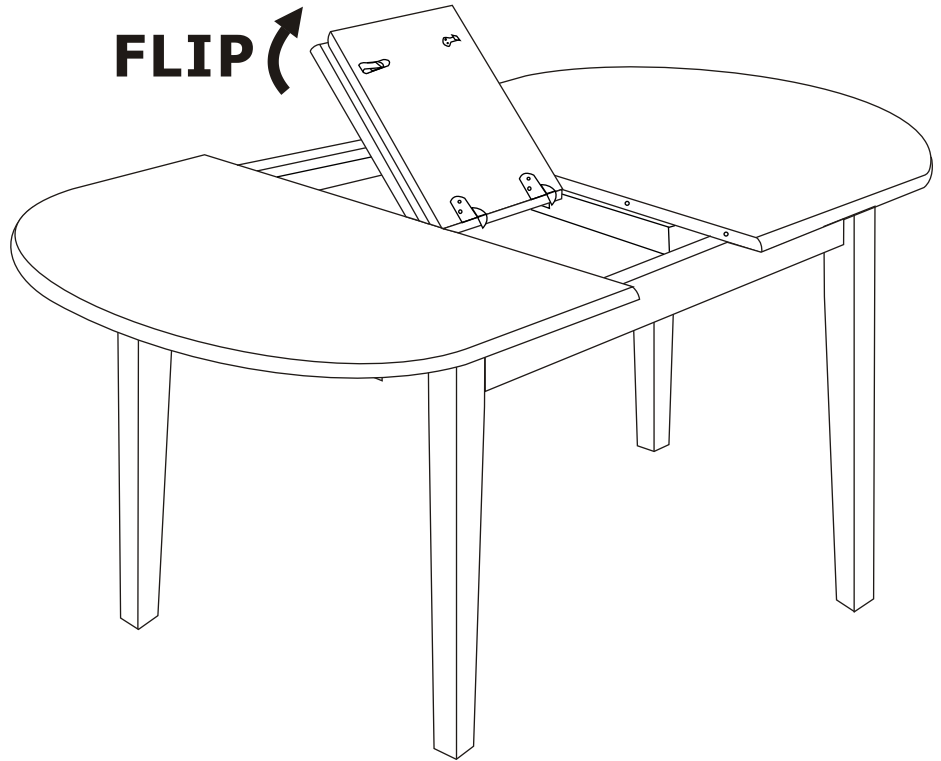

STEP 4

PARTS REQUIRED

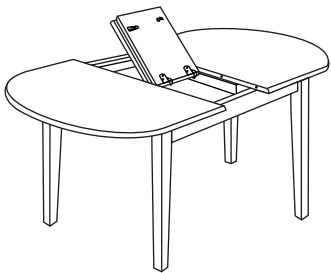

HARDWARE REQUIRED

TOOLS REQUIRED

OPEN

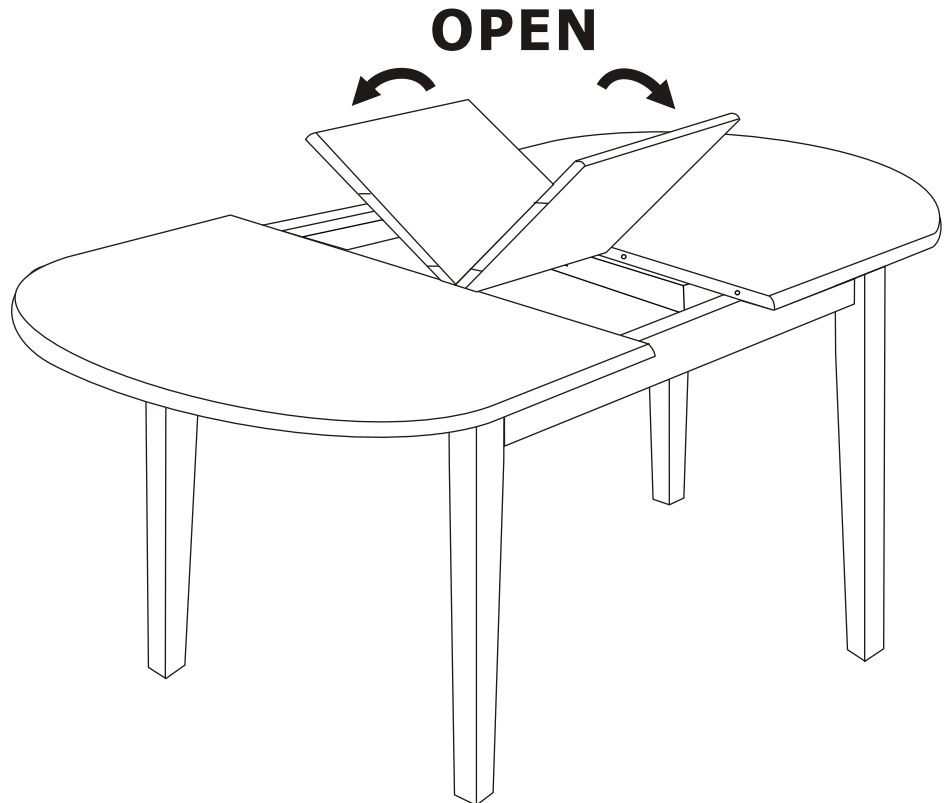

STEP 5

PARTS REQUIRED

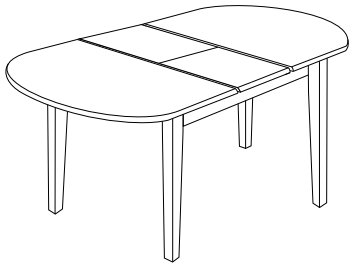

HARDWARE REQUIRED

TOOLS REQUIRED

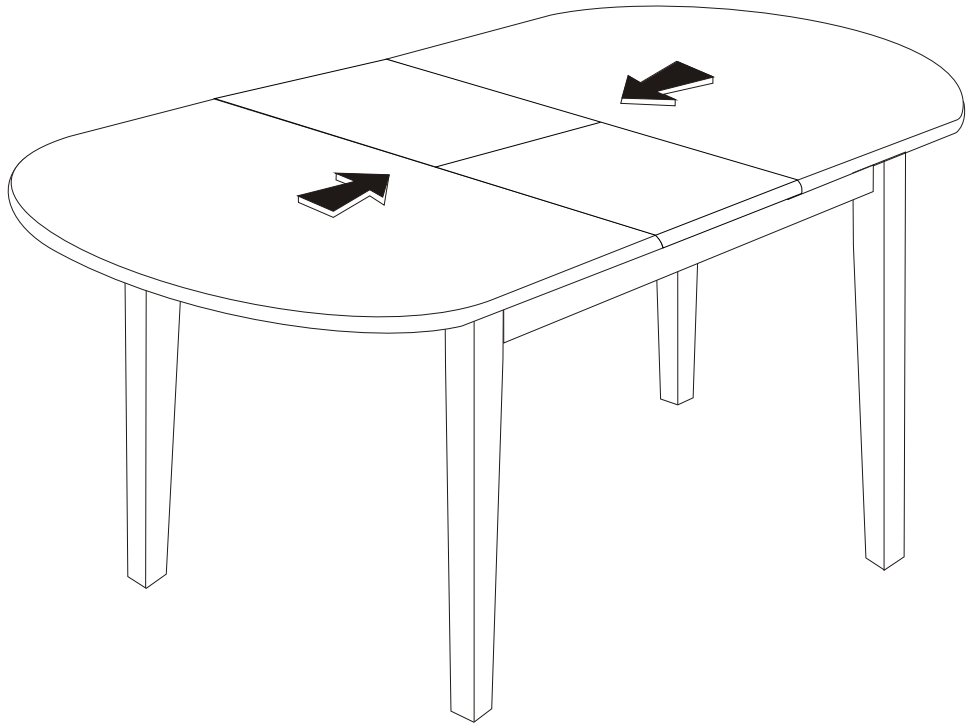

STEP 6

PARTS REQUIRED

HARDWARE REQUIRED

TOOLS REQUIRED

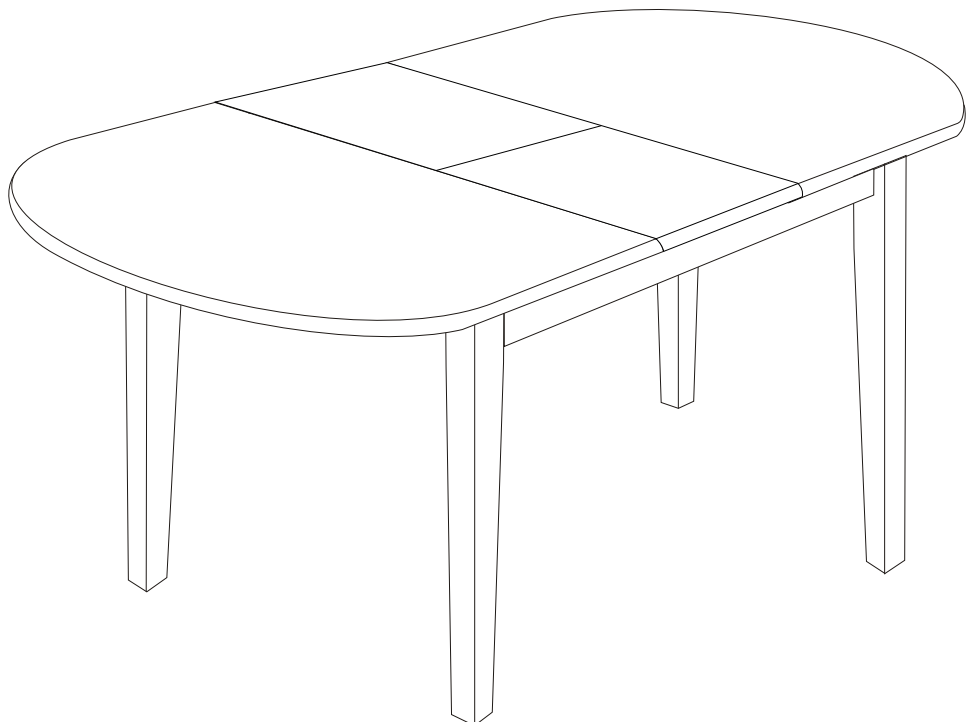

GREY/GREY FABRIC OXFORD DINING CHAIR ASSEMBLY INSTRUCTIONS

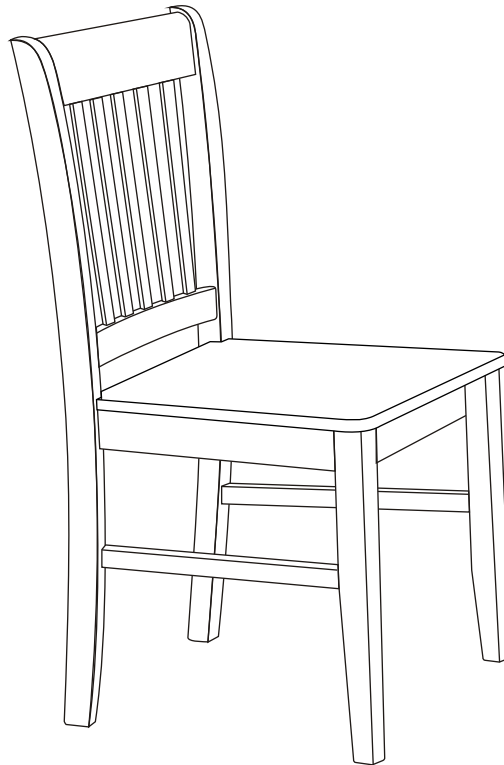

IMPORTANT

FOR DOMESTIC USE ONLY

PLEASE READ BEFORE YOU CONTINUE FURTHER

THE PRODUCT YOU HAVE PURCHASED WILL GIVE YOU MANY YEARS OF SERVICE IF YOU FOLLOW THE GUIDELINES FOR ITS SAFE ASSEMBLY AND PERIODIC MAINTENANCE AND CLEANING.

ASSEMBLE ON A SOFT CLEAN SURFACE.

DO NOT USE ANY TOOLS OTHER THAN THOSE SHOWN.

ANY SPANNERS OR ALLEN KEYS REQUIRED ARE INCLUDED WITH THE FITTINGS KIT.

DO NOT FOR ANY REASON USE A POWER TOOL TO ASSEMBLE THIS PRODUCT. ITS USE WILL INVALIDATE ANY CLAIM YOU MAY HAVE AND COULD MAKE THIS PRODUCT UNSAFE.

DEPENDING ON THE AMOUNT OF USE THIS PRODUCT RECEIVES IT MAY BE NECESSARY TO TIGHTEN UP THE FIXINGS FROM TIME TO TIME.

THIS IS COMPLETELY NORMAL FOR ANY FLAT PACK FURNITURE.

DO NOT OVERTIGHTEN FIXINGS.

FOR CLEANING, YOU MAY USE A DAMP CLOTH (NOT WET). DO NOT USE POLISH, DETERGENT OR CHEMICAL CLEANERS.

THE SURFACE OF THIS ITEM IS NOT HEAT RESISTANT. ALWAYS USE A PLACE MAT UNDER HOT OR COLD ITEMS TO PREVENT MARKING.



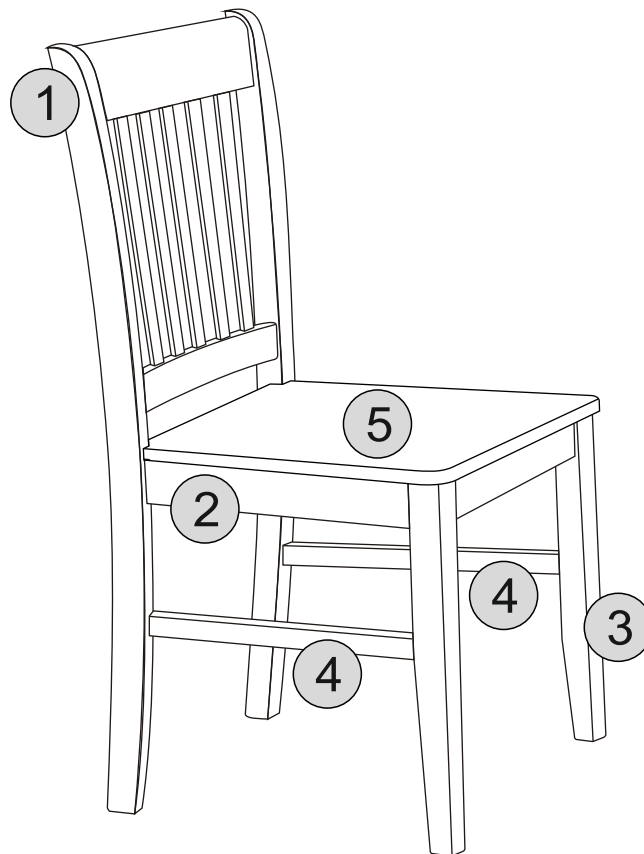

PLEASE CHECK THAT YOU HAVE ALL THE PARTS LISTED BEFORE YOU START ASSEMBLING. IF YOU DO FIND THAT SOMETHING IS MISSING, DO NOT CONTINUE ASSEMBLY. PLEASE CONTACT YOUR SUPPLIER IMMEDIATELY.



PART LIST

Part Number	Part Code	Part Description	Quantity	Carton
1	S400-401-142-PU1-01	Chair Back	2	1/1
2	S400-401-142-PU1-02	Side Stretchers	4	1/1
3	S400-401-142-PU1-03	Front Section	2	1/1
4	S400-401-142-PU1-04	Bottom Stretchers	2	1/1
5	S400-401-142-PU1-05	Chair Seat	4	1/1

HARDWARE LIST





No.	Part Name		Qty	Carton
A	JCBC Bolts		x12	1
B	Spring Washer		x12	1
C	Flat Washer		x12	1
D	Screw		x16	1
E	Allen Key		x1	1

STEP 1

PARTS REQUIRED

- 1 - CHAIR BACK x1
- 2 - SIDE STRETCHERS x1
- 4 - BOTTOM STRETCHERS x1

HARDWARE REQUIRED

- A  01
- B  01
- C  01
- D  01

TOOLS REQUIRED

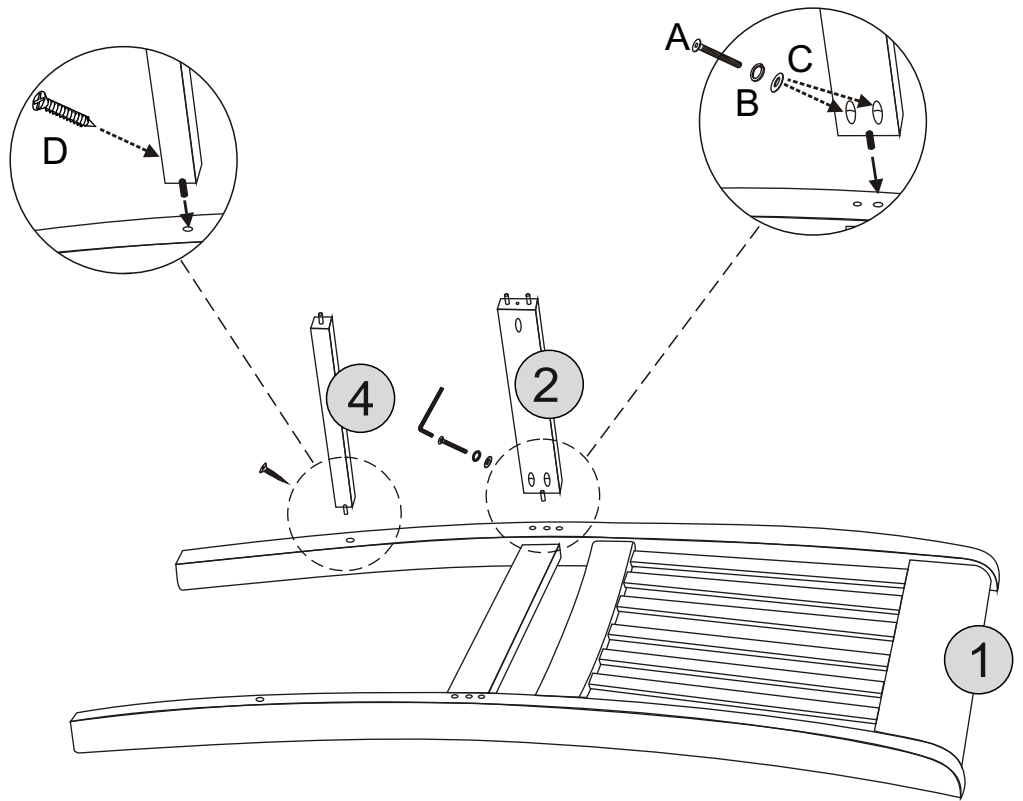
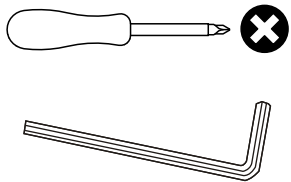



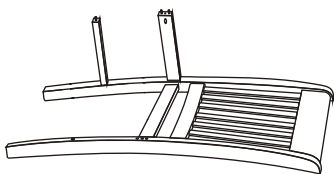

STEP 2

PARTS REQUIRED

- 2 - SIDE STRETCHERS x1
- 5 - BOTTOM STRETCHERS x1



HARDWARE REQUIRED

- A  01
- B  01
- C  01
- D  01

TOOLS REQUIRED

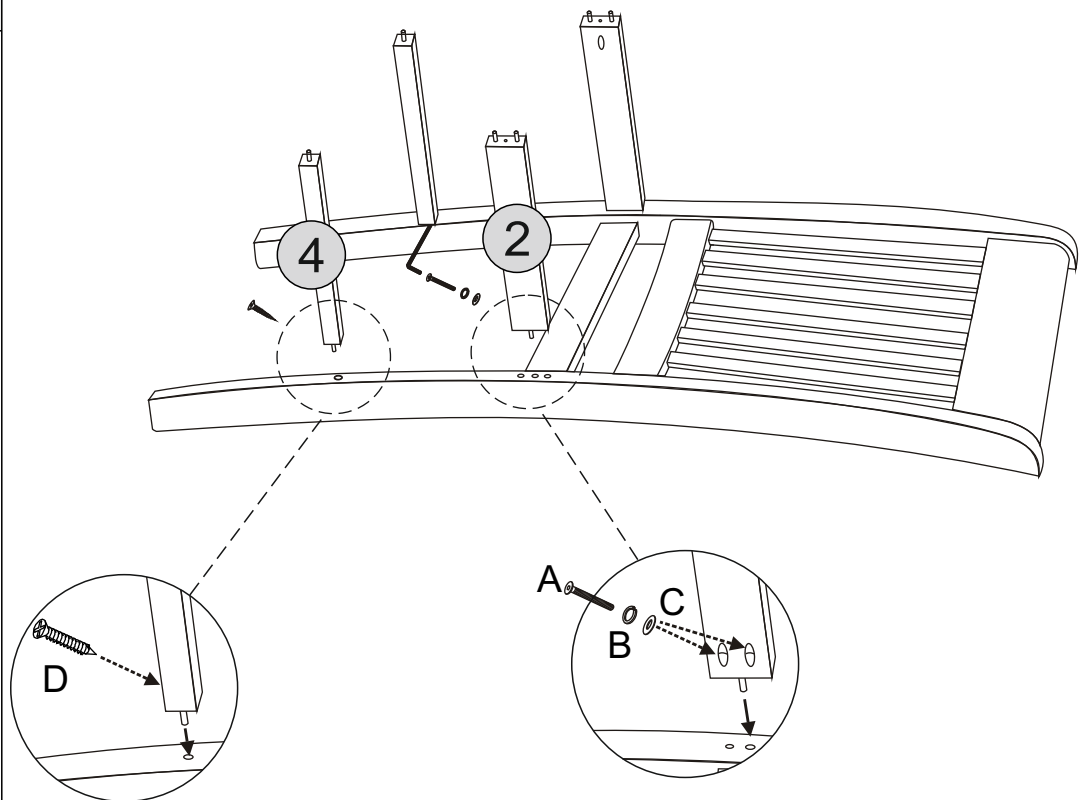
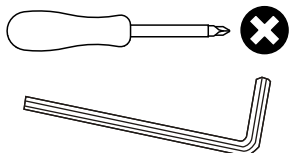

STEP 3

PARTS REQUIRED

3 - FRONT SECTION x1

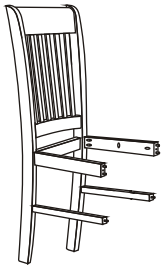

HARDWARE REQUIRED

A  02

B  02

C  02

D  02

TOOLS REQUIRED

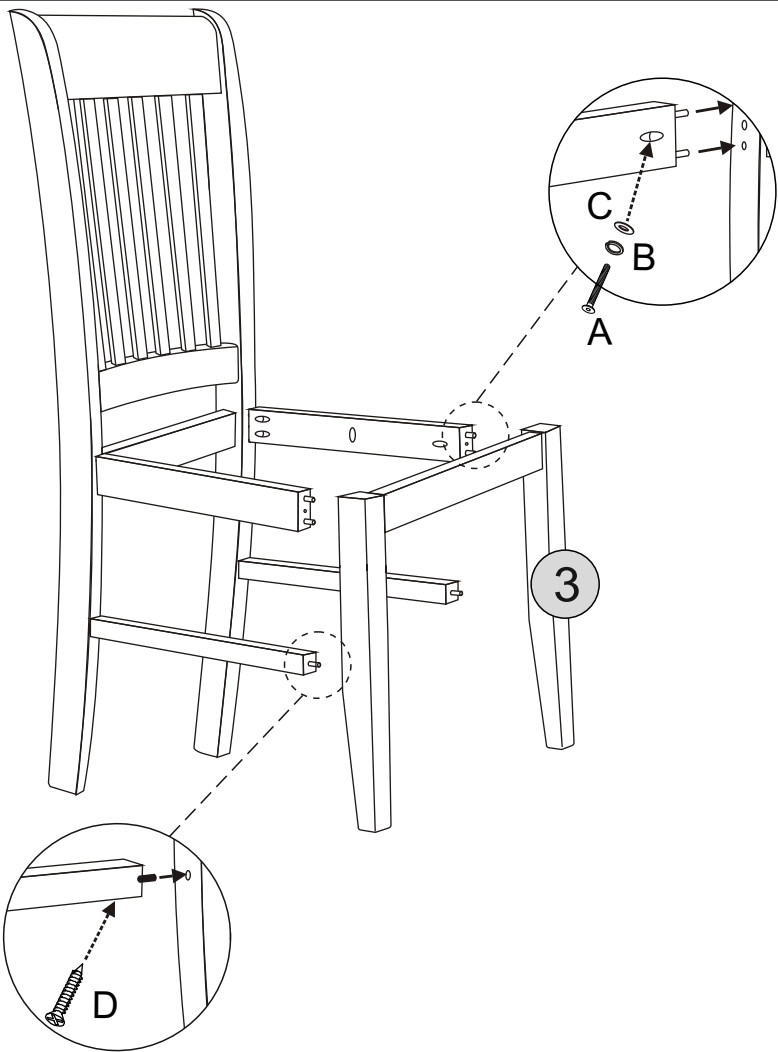
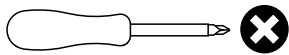

STEP 4

PARTS REQUIRED

5 - SEAT x1

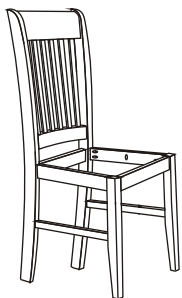

HARDWARE REQUIRED

D  04

TOOLS REQUIRED

