

MAYA 4'6" BED ASSEMBLY INSTRUCTIONS

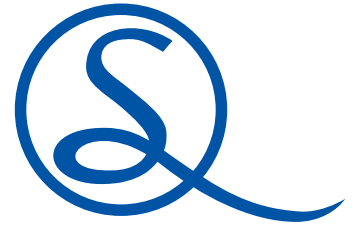
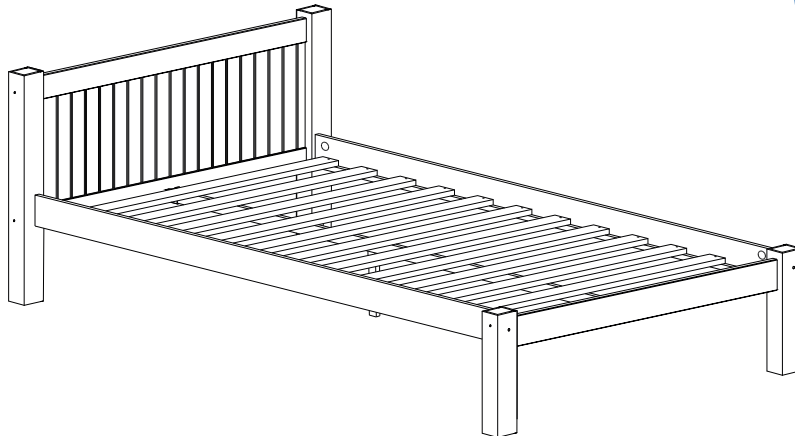

FOR DOMESTIC USE ONLY

IMPORTANT

PLEASE READ BEFORE YOU CONTINUE FURTHER

CARE AND MAINTENANCE

After unpacking this product please keep the original packaging in case it needs to be returned for any reason.

- Please ensure all fittings and parts are present before commencing with assembly.
- We recommend that you lay a blanket or sheet on the floor to avoid damage to both your floor and the product.
- We strongly recommend that you keep children away from your work area.
- Assemble this product as close to its final position as possible.
- Never drag or push products as this could cause damage to the joints making it inferior.
- Do not place this product next to a radiator or in direct sunlight.
- Wood is a natural product and may expand if subjected to damp and may shrink or crack if subjected to heat. Therefore it is recommended that room temperature is maintained, with no sudden temperature fluctuations.
- Make sure any spillage is wiped off immediately.
- Do not place hot or chilled items directly on to the surface, use a place mat or marking will occur.
- For general cleaning use a duster, and do not use detergents of any kind. However, the surface will need to be retreated from time to time. This can be done by using block wax (unperfumed) and rubbing it over the whole item.
- From time to time it may be necessary to tighten fittings, regular inspections should be carried out.

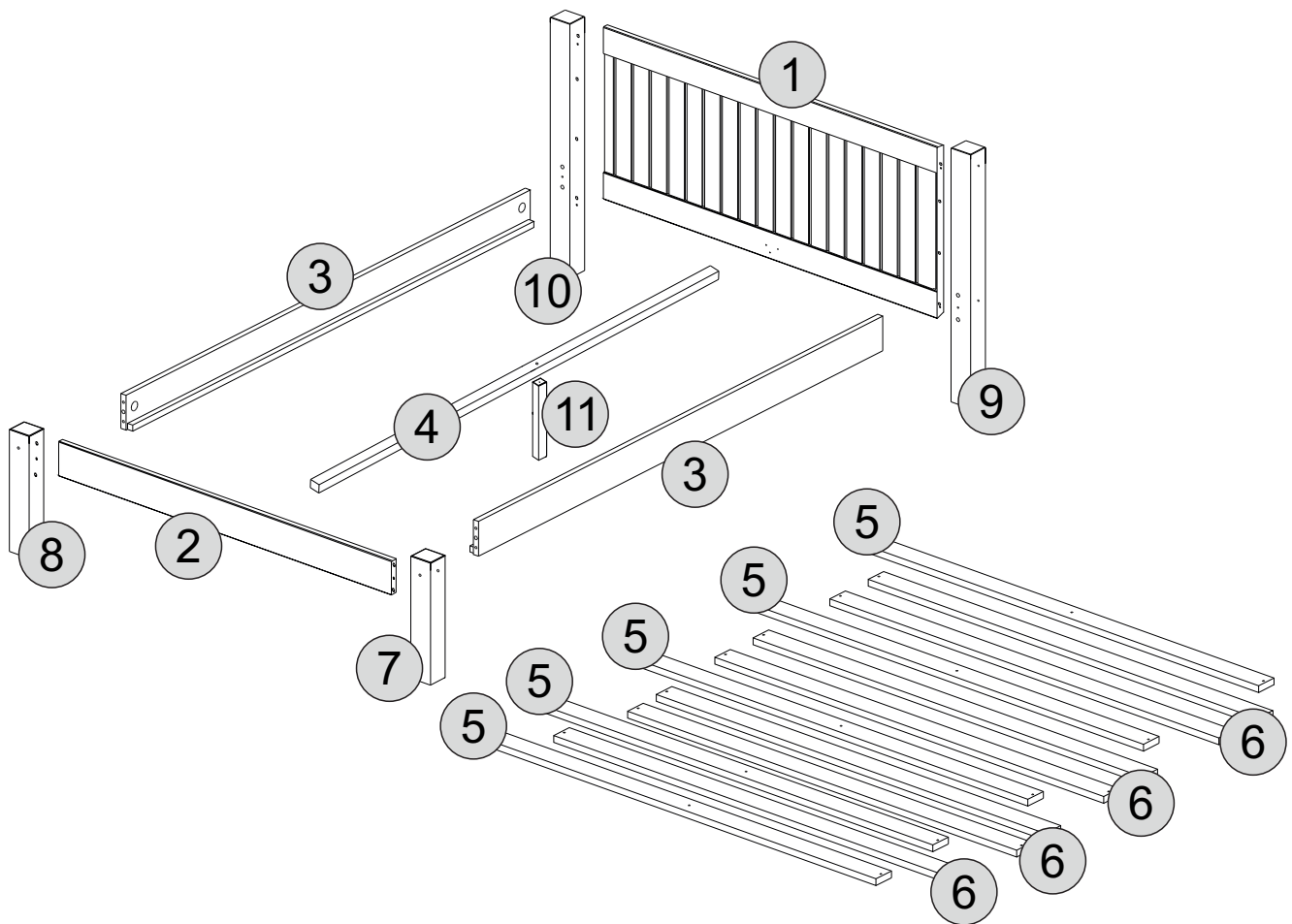









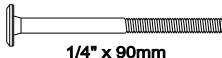
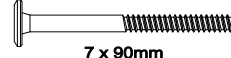

!
 * Use of power tools to assemble this product will invalidate any claim and damage this product making it unsafe !!!
 * Please assemble on a clean soft surface to avoid damage.

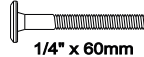
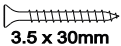
!
 * Please check contents and read the instructions before commencing assembly.
 * Assemble this product following the enclosed instructions carefully.
 * Please take care to avoid damaging panels during assembly.

PARTS LIST

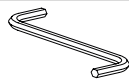
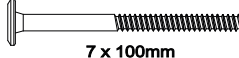
Part Number	Part Code	Part Description	Quantity	Carton
1	S200-203-024-LT1-01	Headboard	1	1/2
2	S200-203-024-LT1-02	Footboard	1	1/2
3	S200-203-024-LT1-03	Siderail	2	2/2
4	S200-203-024-LT1-04	Centre Support Rail	1	2/2
5	S200-203-024-LT1-05	Slat (3 Holes)	5	1/2
6	S200-203-024-LT1-06	Slat (2 Holes)	7	1/2
7	S200-203-024-LT1-07	Right Footboard Post	1	1/2
8	S200-203-024-LT1-08	Left Footboard Post	1	1/2
9	S200-203-024-LT1-09	Right Headboard Post	1	1/2
10	S200-203-024-LT1-10	Left Headboard Post	1	1/2
11	S200-203-024-LT1-11	Centre Support Leg	1	1/2

FITTINGS

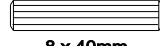
A	 1/4" x 90mm	04	H	 7 x 90mm	01
B	 <small>1/+</small>	04	I	 1/4" x 60mm	02
C	 3.5 x 30mm <small>2/+</small>	29	J		02
D	 10 x 50mm <small>1/+</small>	08	K		02
E		01	L	 7 x 100mm	06
F	(SPACER) (WOODEN) 	02	M	 GLUE	01
G	 4.0 x 16mm <small>1/+</small>	08	N	 8 x 40mm <small>1/+</small>	12

TOOLS REQUIRED

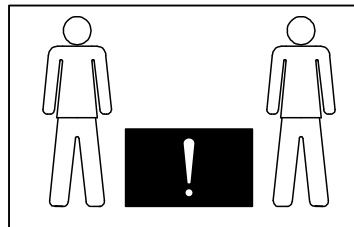
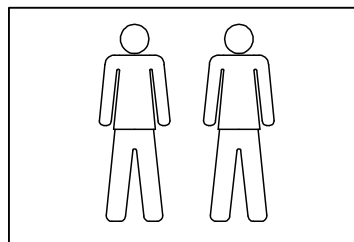
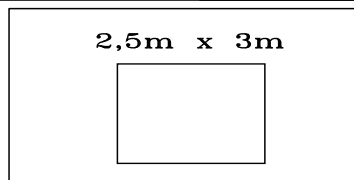
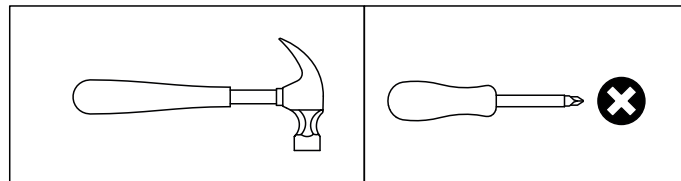



STEP 1

PARTS REQUIRED

- 1 - HEADBOARD x1
- 9 - RIGHT HEADBOARD POST x1
- 10- LEFT HEADBOARD POST x1

HARDWARE REQUIRED

- L  04
- M  01
- N  08

TOOLS REQUIRED

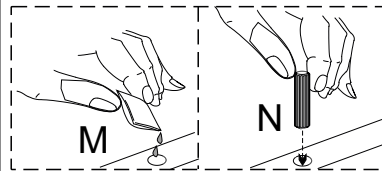
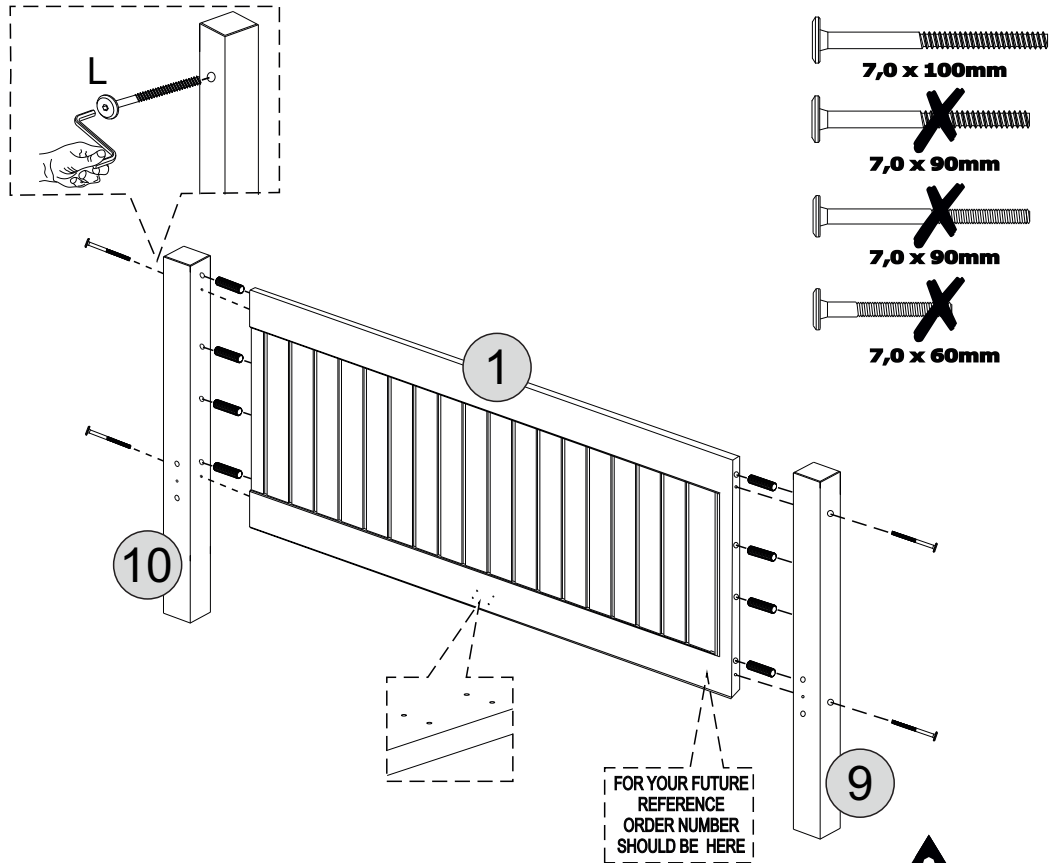
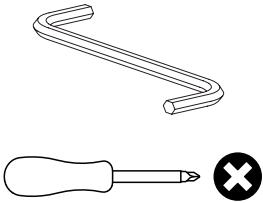



Glue must be added to the dowel holes on parts 1, 9 and 10.

STEP 2

PARTS REQUIRED

- 2 - FOOTBOARD x1
- 7 - RIGHT FOOTBOARD POST x1
- 8- LEFT FOOTBOARD POST x1

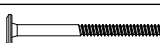
HARDWARE REQUIRED

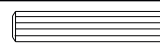
- L  02
- M  01
- N  04

TOOLS REQUIRED

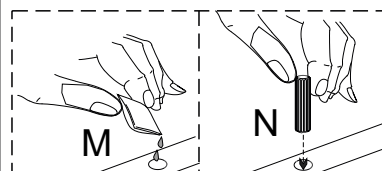
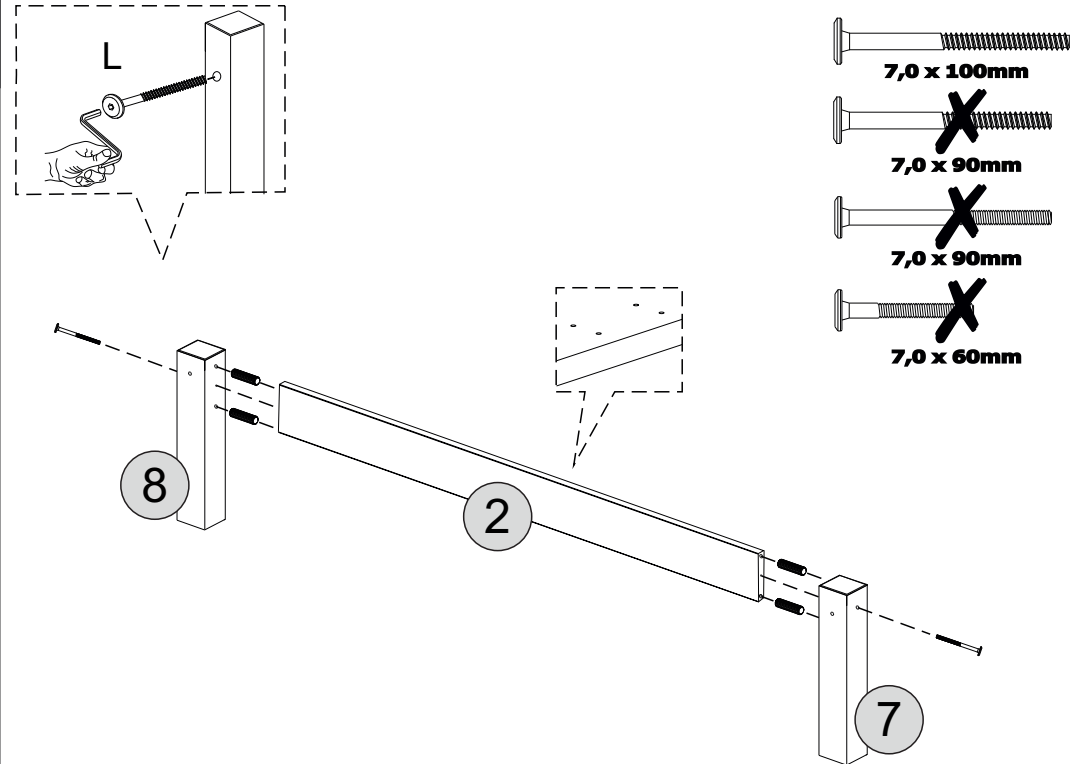
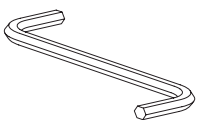

Glue must be added to the dowel holes on parts 2, 7 and 8.

STEP 3

PARTS REQUIRED

3 - SIDERAIL x2

HARDWARE REQUIRED

D  08

TOOLS REQUIRED

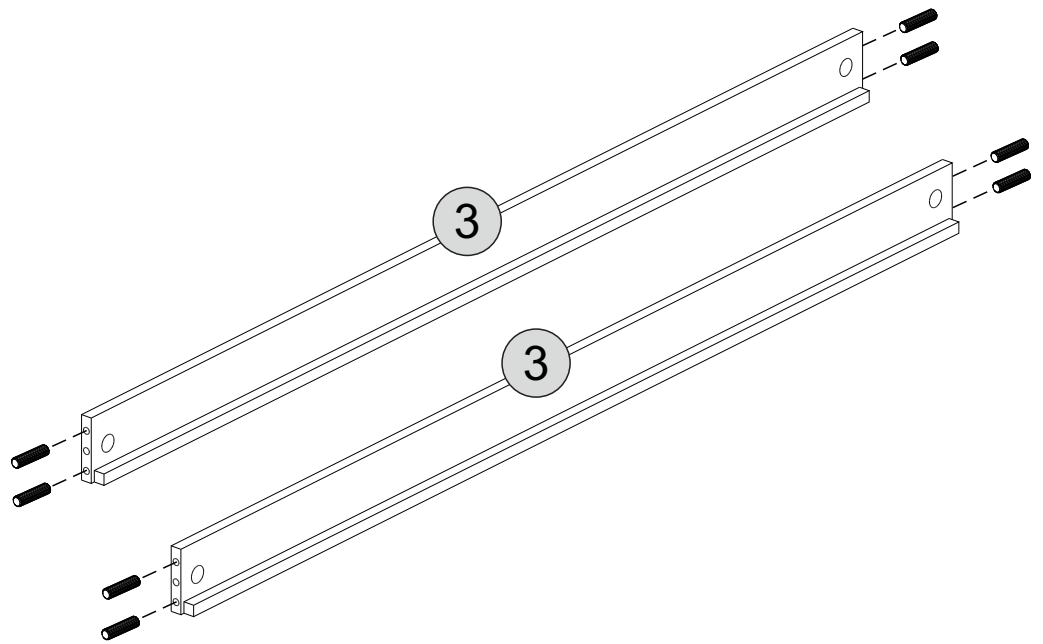

STEP 4

PARTS REQUIRED

3 - SIDERAIL x2

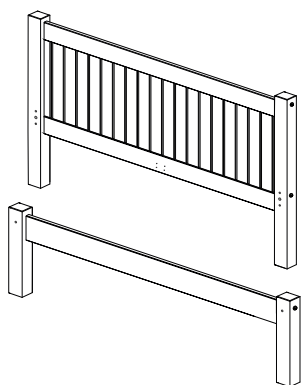

HARDWARE REQUIRED

A  04

B  04

TOOLS REQUIRED

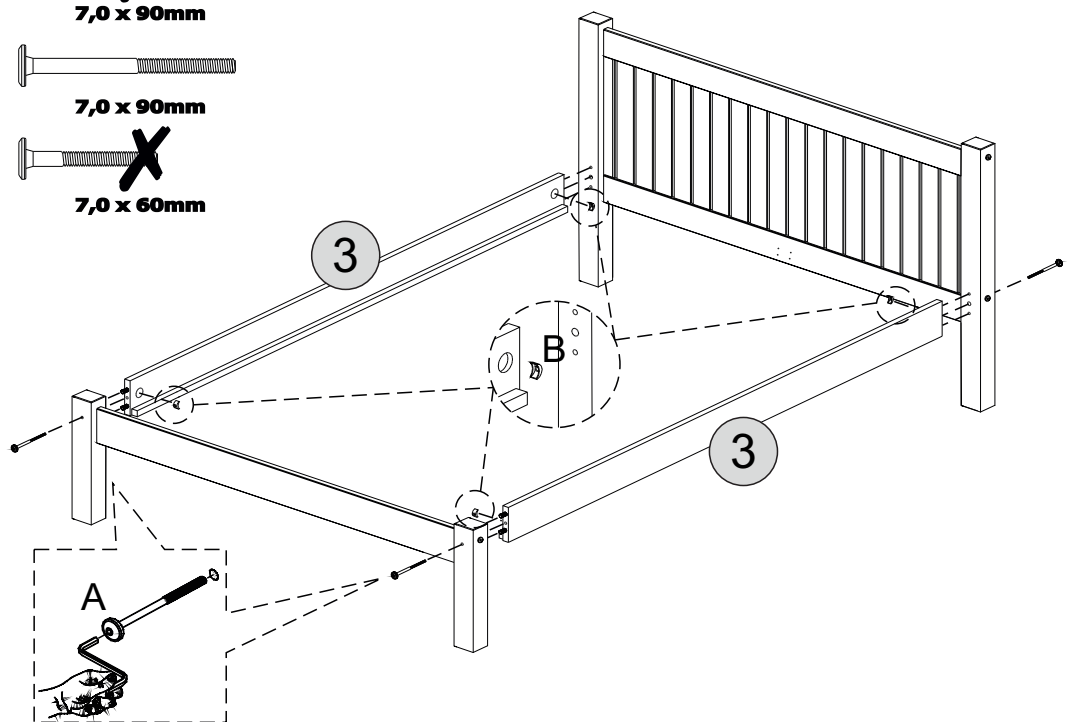
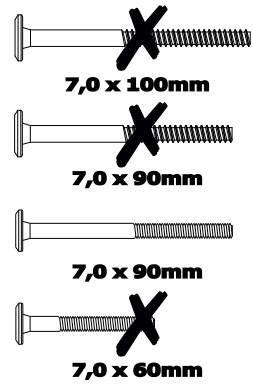
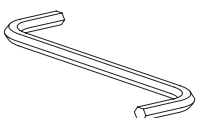

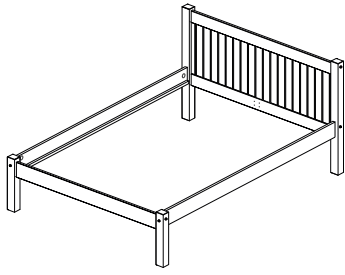

STEP 5

PARTS REQUIRED



HARDWARE REQUIRED

G		08
J		02

TOOLS REQUIRED

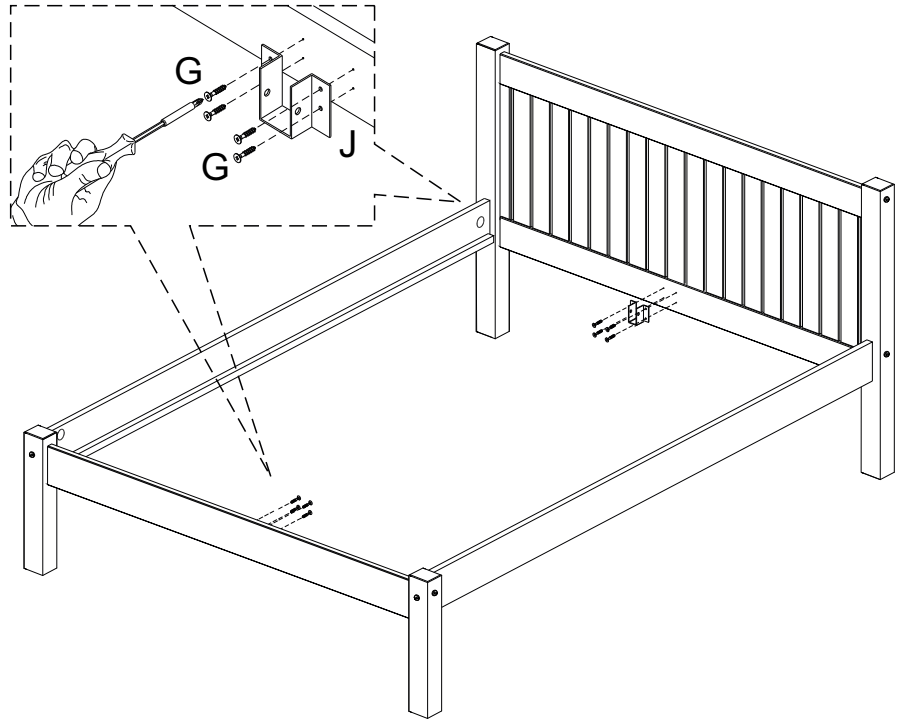
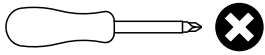



STEP 6

PARTS REQUIRED

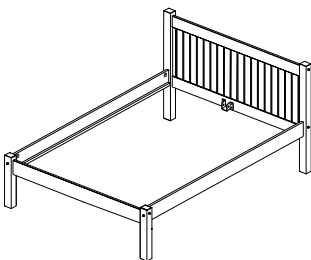
4 - CENTRE SUPPORT RAIL	x1
11 - CENTRE SUPPORT LEG	x1



HARDWARE REQUIRED

H		01
I		02
K		02

TOOLS REQUIRED

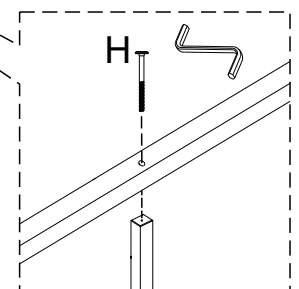
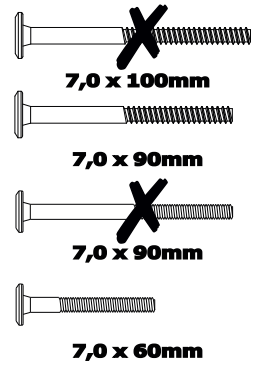
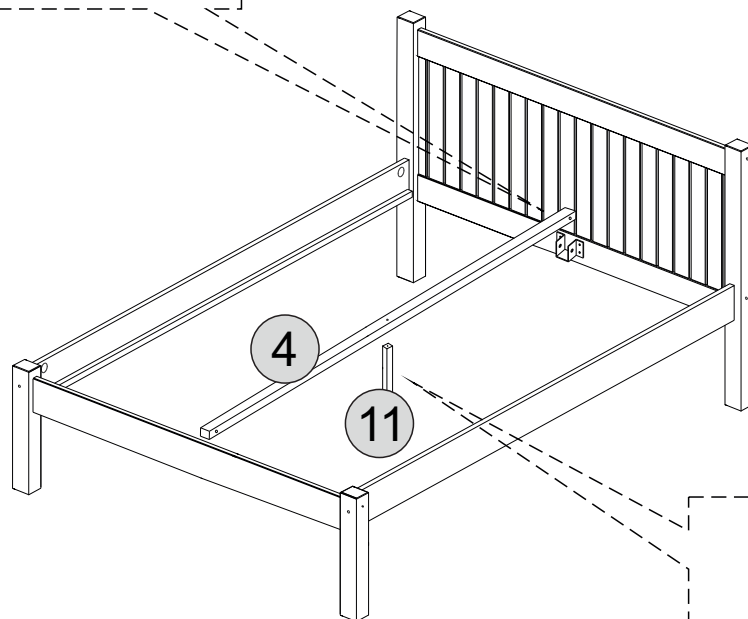
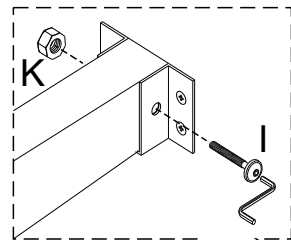
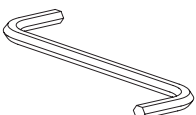

STEP 7

PARTS REQUIRED

5 - SLAT (3 HOLES) x5

6 - SLAT (2 HOLES) x7

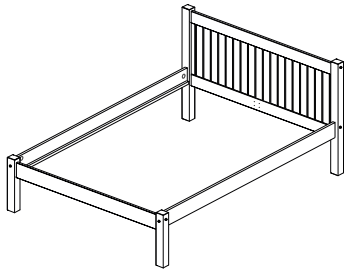

HARDWARE REQUIRED

C  29

F  02

TOOLS REQUIRED

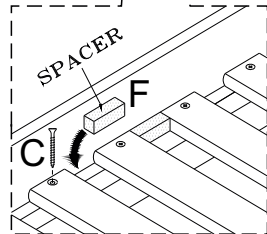
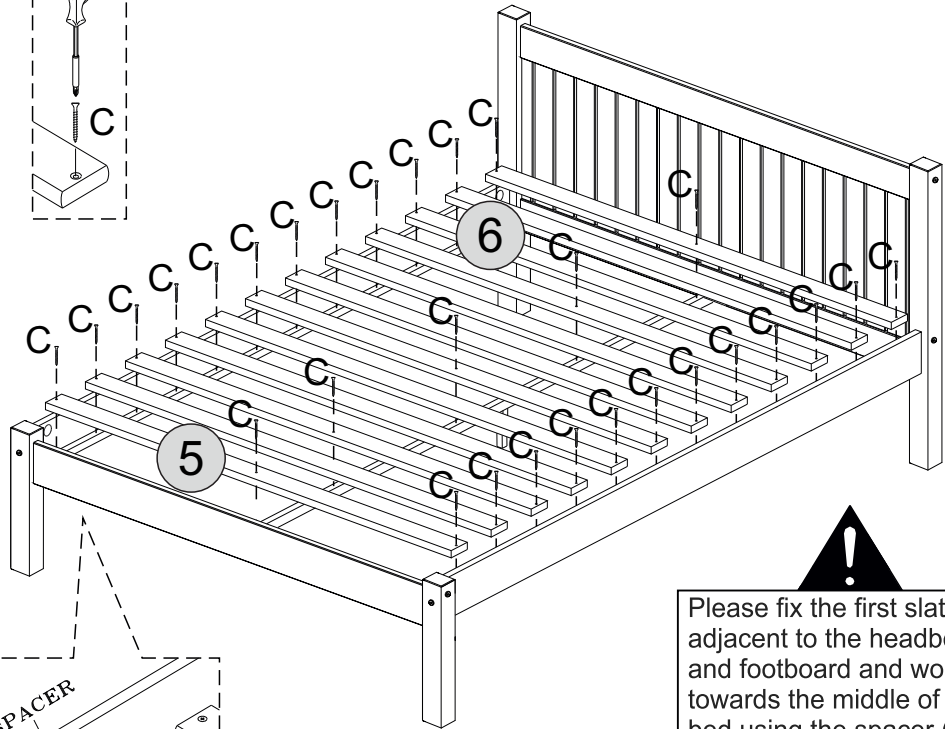
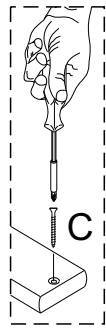
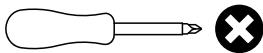

!
Please fix the first slats adjacent to the headboard and footboard and work towards the middle of the bed using the spacer (F) as shown to ensure correct spacing. Fix all the slats to one siderail first then push the second siderail tight against the slats and fix.

STEP 8

PARTS REQUIRED

HARDWARE REQUIRED

TOOLS REQUIRED



**200KG
MAX BED
WEIGHT**